

6280HD GLADIATOR WALK-BEHIND SCRAPER

OPERATING MANUAL



Read Manual Before Operating Machine

Table of Contents

Table of Contents	3
Features and Specifications	4
Safety	6
General Rules for Safe Operation	6
Walk-Behind Scraper Safety Guidelines	7
Hydraulic Safety Tips	8
Components and Assembly	9
Wheel Modes	9
Transport	9
Blades	10
Angle Attachments	11
Operation	12
Start-Up Procedure	12
Speed Control	12
Adding/Removing Slide Weights	12
Types of Applications	12
Troubleshooting Guide	14
Warranty	15

Features and Specifications



Traction Wheels - Industrial grade self-cleaning wheels that disengage for loading/unloading.

Slide Weights with Quick-Adjust Levers - Applies additional pressure to the scraper head or more traction to the wheels as needed.

Lifting Bail Eyebolts - Eases loading/unloading.

Unique Swivel Head - Provides continuous contact with the floor.

Quick-Adjust Multi-Position Handle - Allows adjustment of handle angle to suit operator or work conditions. Folds flat over machine for storage or transport.

Forward/Reverse Handles - Controls direction of movement.

Speed Control Dial - Limits maximum forward speed.

Product Specifications									
Width	Max. Length	Max. Height	Weight	Speed	RPM	Amps	Vibration		
							X Axis	Y Axis	Z Axis
17.75" (451 mm)	29" (736.6 mm)	46" (1,168 mm) (max. height) 30" (762 mm) (handle folded)	334 lbs (151.5 kg) (machine only) 424 lbs (192.3 kg) (with weights)	10-45 ft/min (USA only) 0-20 m/min	3450	1.5	3.2 m/s ²	5.1 m/s ²	5.0 m/s ²

Features and Specifications

Machine Variants			
Region	Serial Number	Input Power	Body Panels
Domestic	6280HD-COM-10XXXX	120V / 60 Hz	Silver Vein
	6280HD-COM-12XXXX	120V / 60 Hz	Green
	6280HD-COM-23XXXX	120V / 60 Hz	Silver Vein
International	6280HD-COM-11XXXX	230V / 50 Hz	Silver Vein
	6280HD-COM-13XXXX	230V / 50 Hz	Silver Vein
	6280HD-COM-20XXXX	110V / 50 Hz	Silver Vein
	6280HD-COM-26XXXX	230V / 50 Hz	Silver Vein
	6280HD-COM-27XXXX	230V / 50 Hz	Silver Vein
	6280HD-COM-28XXXX	100V / 50/60 Hz	Silver Vein

Safety

GENERAL RULES FOR SAFE OPERATION

Before use, anyone operating or performing maintenance on this equipment must read and understand this manual, as well as any labels packaged with or attached to the machine and its components. Read the manual carefully to learn equipment applications and limitations, as well as potential hazards associated with this type of equipment. Keep manual near machine at all times. If your manual is lost or damaged, contact National Flooring Equipment (NFE) for a replacement.

Personal

Dress properly and use safety gear.

Do not wear loose clothing; it may be caught in moving parts. Anyone in the work area must wear safety goggles or glasses and hearing protection. Wear a dust mask for dusty operations. Hard hats, face shields, safety shoes, etc. should be worn when specified or necessary.

Maintain control; stay alert.

Keep proper footing and balance, and maintain a firm grip. Observe surroundings at all times. Do not use when tired, distracted, or under the influence of drugs, alcohol, or any medication that may cause decreased control.

Keep hands away from all moving parts and tooling.

Wear gloves when changing tooling. Remove tooling when machine is not in use and/or lower cutting head to the floor.

Do not force equipment.

Equipment will perform best at the rate for which it was designed. Excessive force only causes operator fatigue, increased wear, and reduced control.

Environment

Avoid use in dangerous environments.

Do not use in rain, damp or wet locations, or in the presence of explosive atmospheres (gaseous fumes, dust, or flammable materials). Remove materials or debris that may be ignited by sparks. Keep work area tidy and well-lit - a cluttered or dark work area may lead to accidents. Extreme heat or cold may affect performance.

Protect others in the work area and be aware of surroundings.

Provide barriers or shields as needed to protect others from debris and machine operation. Children and other bystanders should be kept at a safe distance from the work area to avoid distracting the operator and/or coming into contact with the machine. Operator should be aware of who is around them and their proximity. Support personnel should never stand next to, in front of, or behind the machine while the machine is running. Operator should look behind them before backing up.

Do not come within 3 ft. of the machine's perimeter during operation.

Guard against electric shock.

Ensure that machine is connected to a properly grounded outlet. Prevent bodily contact with grounded surfaces, e.g. pipes, radiators, ranges, and refrigerators. When scoring or making cuts, always check the work area for hidden wires or pipes.

Maintenance & Repairs

Begin maintenance work only when the machine is shut down, unplugged, and cooled down.

Use proper cleaning agents.

Ensure that all cleaning rags are fiber-free; do not use any aggressive cleaning products.

Schedule regular maintenance check-ups.

Ensure machine is properly cleaned and serviced. Remove all traces of oil, combustible fuel, or cleaning fluids from the machine and its connections and fittings. Retighten all loose fittings found during maintenance and repair work. Loose or damaged parts should be replaced immediately; use only NFE parts.

Do not weld or flame-cut on the machine during repairs, or make changes to machine without authorization from NFE.

Equipment

Use proper parts and accessories.

Only use NFE-approved or recommended parts and accessories. Using any that are not recommended may be hazardous.

Ensure accessories are properly installed and maintained.

Do not permanently remove a guard or other safety device when installing an accessory or attachment.

Inspect for damaged parts.

Check for misalignment, binding of moving parts, loose fasteners, improper mounting, broken parts, and any other conditions that may affect operation. If abnormal noise or vibration occurs, turn the machine off immediately. Do not use damaged equipment until repaired. Do not use if power switch does not turn machine on and off. For all repairs, insist on only identical NFE replacement parts.

Maintain equipment and labels.

Keep handles dry, clean, and free from oil and grease. Keep cutting edges sharp and clean. Follow instructions for lubricating and changing accessories. Motor and switches should be completely enclosed at all times with no exposed wiring. Inspect cord regularly. Labels carry important information; if unreadable or missing, contact NFE for a free replacement.

Avoid accidental starting; store idle equipment.

When not in use, ensure that the machine is unplugged; do not turn on before plugging in. Store in a dry, secured place. Remove tooling when storing, and keep away from children.



CAUTION! ENSURE PROPER USE OF EXTENSION CORDS. IF AMP DRAW IS HIGHER THAN SHOWN ON TABLE OR CORD IS LONGER THAN 50 FT, SEE AN ELECTRICIAN.

ASSUMPTIONS: 3% ALLOWABLE VOLTAGE DROP, COPPER CONDUCTORS RATED FOR 75°C, 1.25 SAFETY FACTOR, CORD VOLTAGE RATING OF 600VAC, PROPER CORD TYPES (STO, STOW, SOOW).

Amp Draw	Gauge
0-12	14
13-16	12
14-24	10
25-40	8

WALK-BEHIND SCRAPER SAFETY GUIDELINES

Before use, anyone operating this equipment must read and understand these safety instructions.

Scraping

Beware of hidden obtrusions.

Watch out for hidden dangers and protrusions in flooring. Do not use on largely uneven surfaces.

Observe location of electrical supplies and extension cords.

Do not allow cutting heads to come into contact with any electrical supply or extension cord.

Use correct tooling and accessories.

Provide barriers or shields as needed to protect others from debris. After mounting tooling, check for proper alignment.

Use for correct applications.

Do not force equipment to do heavier duty work than it was made for.



WARNING: GRINDING/CUTTING/DRILLING OF MASONRY, CONCRETE, METAL AND OTHER MATERIALS CAN GENERATE DUST, MISTS AND FUMES CONTAINING CHEMICALS KNOWN TO CAUSE SERIOUS FATAL INJURY OR ILLNESS, SUCH AS RESPIRATORY DISEASE, CANCER, BIRTH DEFECTS OR OTHER REPRODUCTIVE HARM. IF YOU ARE UNFAMILIAR WITH THE RISKS ASSOCIATED WITH THE PARTICULAR MATERIAL BEING CUT, REVIEW THE MATERIAL SAFETY DATA SHEET AND/OR CONSULT YOU EMPLOYER, THE MATERIAL MANUFACTURER/SUPPLIER, GOVERNMENTAL AGENCIES SUCH AS OSHA AND NIOSH AND OTHER AUTHORITIES ON HAZARDOUS MATERIALS. CALIFORNIA AND SOME OTHER AUTHORITIES, FOR INSTANCE, HAVE PUBLISHED LISTS OF SUBSTANCES KNOWN TO CAUSE CANCER, REPRODUCTIVE TOXICITY, OR OTHER HARMFUL EFFECTS. CONTROL DUST, MIST AND FUMES AT THE SOURCE WHERE POSSIBLE. IN THIS REGARD USE GOOD WORK PRACTICES AND FOLLOW THE RECOMMENDATIONS OF THE MANUFACTURER/SUPPLIER, OSHA/NIOSH, AND OCCUPATIONAL AND TRADE ASSOCIATIONS. WHEN THE HAZARDS FROM INHALATION OF DUST, MISTS AND FUMES CANNOT BE ELIMINATED, THE OPERATOR AND ANY BYSTANDERS SHOULD ALWAYS WEAR A RESPIRATOR APPROVED BY OSHA/MSHA FOR THE MATERIAL BEING CUT.

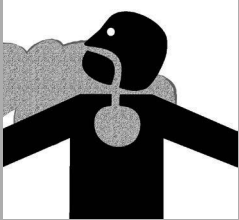

Safety

HYDRAULIC SAFETY

Maintaining a Safe Work Environment

Establishing a safe work environment in and around your hydraulic equipment is extremely important. The easiest and most effective way to avoid problems is to make sure associates understand their equipment, know how to operate the machines safely, and recognize the dangers if handled carelessly. A few things to be aware of are:

- **Pressure:** Hydraulic fluid under pressure is dangerous and can cause serious injury. Never look for a leak when unit is under pressure. Using your hand could cause serious injury. A few common ways to encounter hydraulic fluid under pressure include:
 - Pinhole: Fluid under pressure can cause serious injury. It can be almost invisible escaping from a pinhole, and it can pierce the skin into the body.



DANGER: DO NOT TOUCH A PRESSURIZED HYDRAULIC HOSE ASSEMBLY WITH ANY PART OF THE BODY. IF FLUID PUNCTURES THE SKIN, EVEN IF NO PAIN IS FELT, A SERIOUS EMERGENCY EXISTS. OBTAIN MEDICAL ASSISTANCE IMMEDIATELY. FAILURE TO DO SO COULD RESULT IN LOSS OF THE INJURED BODY PART OR DEATH.

- Leak: Keep fittings and hoses tight. Only check and service when not under pressure. Leaking hydraulic fluid is hazardous; in addition to making workplace floors slippery and dangerous, it also contaminates the environment. Before cleaning an oil spill, always check EPA, state, and local regulations.
- Burst: Whether due to improper selection or damage, a ruptured hose can cause injury. If it bursts, a worker can be burned, cut, injected, or may slip and fall.
- Coupling Blow-Off: If the assembly is not properly made or installed, the coupling could come off and hit or spray a worker, possibly resulting in serious injury. Never operate machine without guards.
- **Flammability:** When ignited, some hydraulic fluids can cause fires and/or explode. With the exception of those comprised primarily of water, all hydraulic fluid is flammable (including many “fire-resistant” hydraulic fluids) when exposed to the proper conditions. Leaking pressurized hydraulic fluids may develop a mist or fine spray that can flash or explode upon contact with a source of ignition. These explosions can be very severe and could result in serious injury or death. Precautions should be taken to eliminate all ignition sources from contact with escaping fluids, sprays or mists resulting from hydraulic failures. Sources of ignition could be electrical discharges (sparks), open flames, extremely high temperatures, sparks caused by metal-to-metal contact, etc.



CAUTION: NEVER USE YOUR HANDS TO CHECK FOR LEAKS OVER HOSE OR HYDRAULIC CONNECTIONS. USE A PIECE OF CARDBOARD TO LOCATE A PRESSURIZED LEAK. FOR LOW PRESSURE LEAKS (DRIPS), USE A RAG TO CLEAN THE AREA AND DETERMINE WHERE THE LEAK ORIGINATES.

- **Mechanical:** Hydraulic fluid creates movement, which means some equipment may move. Observe surroundings and equipment at all times.
- **Moisture:** Do not use in wet or high moisture conditions.
- **Electrical:** Faulty wiring can be an electrical hazard. A regular preventive maintenance program should always include a wiring check. If applicable, disconnect battery before servicing.
- **Temperature:** Because this machine operates at a relatively low pressure, overheating is not common. If surface of tank becomes too hot to touch by hand (above 130°F or 55°C), shut off machine and allow it to cool.

Hydraulic Fluid

Only use Texaco Rando 46 Hydraulic Oil or compatible fluid like ISO or AW #46 from a brand name manufacturer. Non-compatible fluids could cause damage to unit or serious injury.

Components and Assembly

WHEEL MODES

Wheels engage and disengage for better maneuverability. Wheels in the “engage mode” are secured with axle pins (Figure 1), which engage the wheels so the machine can be self-propelled.

When wheels are in the “disengage mode” (Figure 1.1), the machine can be moved freely when not under power.

Disengaging Wheels

1. Lift ring outwards; slide pin out and off.
2. Repeat on second wheel.

Note: Keeping the axle pin facing straight up will make re-engaging easier.

Re-engaging Wheels

1. Line up wheel hub hole and axle hole (Figure 2).
2. Insert pin and push ring over the hole so that it is parallel to the wheel.
3. Repeat on second wheel.



FIG. 1

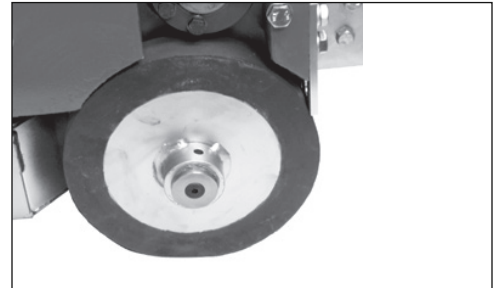

FIG. 1.1

TRANSPORT

Lifting Bail

The lifting bails make loading/unloading easier when unable to use a ramp. Location of lifting bails centers the balance of the machine, making it safe to pick up machine.

1. Place rope, hook system, or chain through eyelets located on top of machine.
2. Raise machine with a fork lift or winch; slowly lower to desired location.

Ramp Loading

1. Engage the wheels.
2. Make sure ramp is clean and dry, free of grease or oil.
3. Position ramp securely to back of vehicle; ensure there is good contact (Figure 3).
4. Position machine at bottom of ramp (Figure 3.1).
5. Engage power switch and drive onto vehicle.

Ramp Unloading

1. Engage the wheels.
2. Position ramp securely to back of vehicle; ensure there is good contact (Figure 3).
3. Position machine in line with the ramp at the back of the truck (Figure 3.1).
4. Carefully move machine onto ramp, leaving the cutting head in contact with the ramp surface. **Note:** Machine is heavy, be cautious while moving.
5. Slowly back machine down ramp.

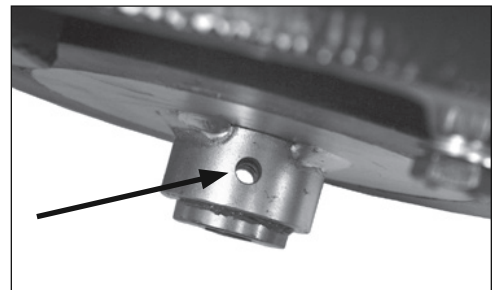

FIG. 2

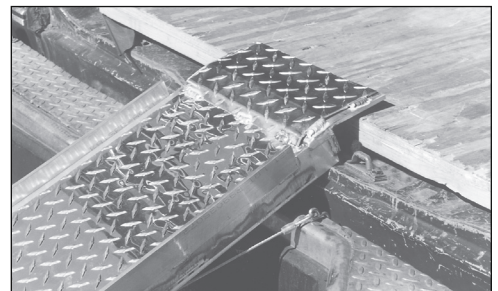

FIG. 3

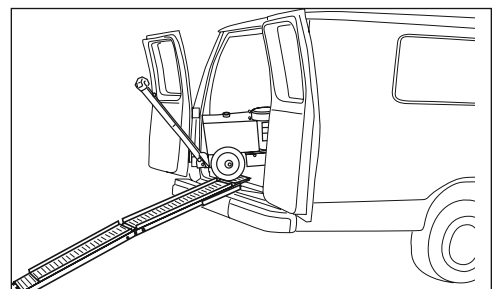
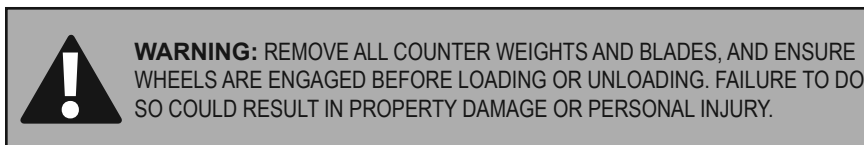

FIG. 3.1



Components and Assembly

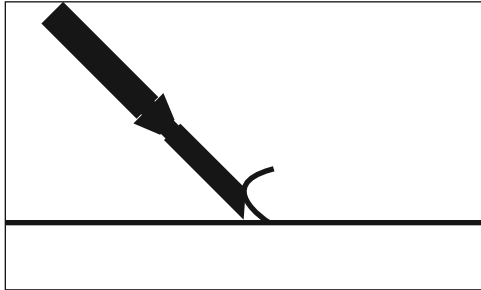

FIG. 4

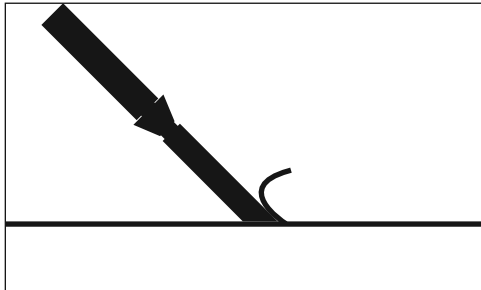

FIG. 4.1



FIG. 4.2

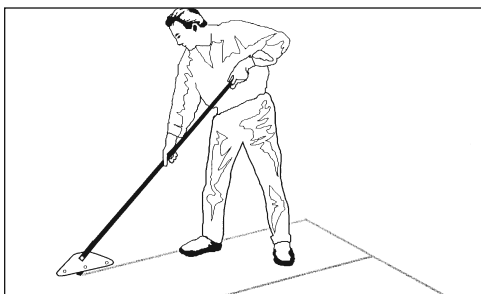

FIG. 5

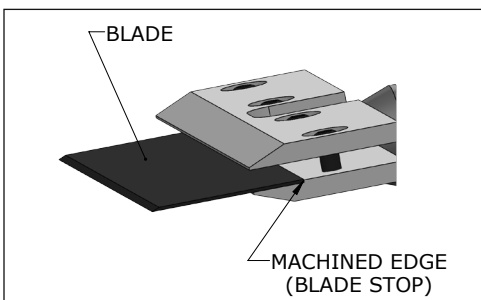

FIG. 6

BLADES



CAUTION: BLADES ARE SHARP, USE EXTREME CAUTION WHEN HANDLING. NEVER CHANGE CUTTING HEAD OR SERVICE BLADES WHILE MACHINE IS RUNNING. ALWAYS WEAR GLOVES AND EYE PROTECTION WHEN HANDLING BLADES.

Blade Setting

Note: This machine is designed for soft goods and most hard good removal applications.

- Depending on the material and sub-floor type, proper blade size and placement will affect performance.
- For harder jobs, use a smaller blade.
- Start with a narrow blade, then increase blade size to optimize cutting pass. Narrower blades work easier than wider blades, and usually clean the floor better. Wider is not always better or faster.
- Normally, bevel on the blade is up for concrete (Figure 4); bevel down for wood (Figure 4.1).
- Dull blades greatly affect the performance of the machine and reduce cutting ability. Sharpen or replace as needed.
- Keep work area clean and clear of debris. After removing a portion of material, move it out of the way.
- Pound down or remove any nails or metal obstruction on wood or wood-like floors to avoid blade damage.
- Blades can be offset in the cutting head (Figure 4.2) for easier access to toe kicks or for removal along the wall.
- Sheet vinyl, solid vinyl, rubber tile, urethane, or PVC sheet roofing will need to be scored for best results. Use NFE's #584 scoring tool (Figure 5) to score flooring to the width of the blade.
- Self-scoring blades eliminate the need for pre-scoring material. Depending upon the type of material being removed and the sharpness of the blade and scoring wings, the self-scoring blades may make it harder to control the machine. Keep scoring wings sharp at all times.

Blade Changing

1. Place a flat piece of wood under the front of the machine.
2. Use supplied extended "T" wrench or a 7/32 Allen wrench with at least a 3" extension to keep hand safely away from the sharp edge of the blade. Loosen four Allen head bolts. It is not necessary to remove bolts.
3. Place blade into the cutting head and slide back until fully seated against the machined edge (Figure 6).

Note: Do not insert blade all the way back to the bolts. Incorrect installation of blade will cause insufficient clamping leading to premature blade wear and damage.

If the blade is wider than the cutting head, center the blade to the head. If the blade is smaller than the cutting head, the blade should be mounted in the center of the cutting head during the first pass. After the first pass is made, the blade can be offset in the head to allow the wheels to keep even contact with the floor and provide easy access to the wall.

4. Tighten the bolts.

Components and Assembly

Blade Sharpening

During use, blades develop a back-bevel (Figure 7). Blade will not be completely sharpened until all back-bevel is gone.

Note: *Thinner blades are easier to sharpen, but they also break easier.*

- Grind blade using a 4" diameter disk with 120 or finer grit. Be careful not to catch disk on edge or corner of blade.
- Pass grinder along blade edge, starting on one end and continuing in one direction. Grind until sharp.
- Using a good quality fine tooth hand file, use same procedure as above.
- Have plenty of sharp blades on each job so that on-the-job blade sharpening is eliminated.
- It is best to sharpen dull blades on proper bench or belt grinder.

Self-Scoring Blade Sharpening

It is important to keep the "wings" on a self-scoring blade sharp (Figure 8). Use a file on the wing edge. Sharpen the flat part of the blade the same way as described above.

ANGLE ATTACHMENTS

These attachments angle the cutting head and blade or carbide shank to where the material comes up the easiest. Lower is usually the best.

Mounting Angle Attachment

1. Mount angle attachment onto the cutting head support (Figure 9).
2. Securely tighten all five mounting bolts.

Mounting Blade Holder/Shank

1. Disconnect machine from power source.
2. Block up machine.
3. Insert desired cutting head or carbide shank into the angle attachment.

Note: *Cutting head or carbide shank should swivel freely in the angle attachment. This movement allows the blade to stay in contact with the floor. Grease may need to be applied to the shaft of the attachment before inserting.*

4. Secure with retainer cap (Figure 9.1).

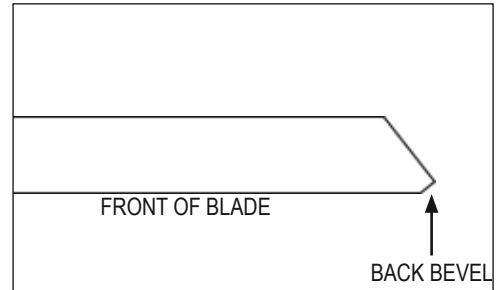

FIG. 7

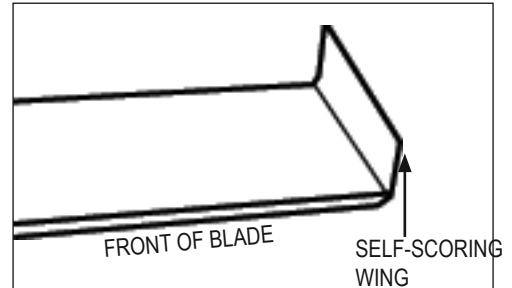

FIG. 8



FIG. 9

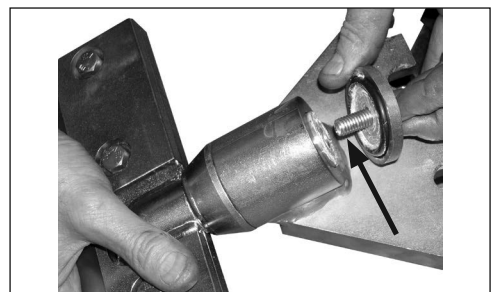

FIG. 9.1

Operation

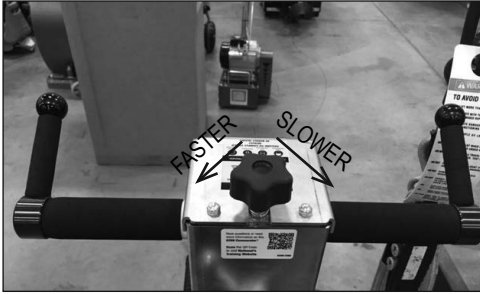

FIG. 10

START-UP PROCEDURE

1. Machine must be switched off before plugging machine into power source.
2. Plug machine into outlet.
3. Turn speed control to slowest position.
4. For domestic machines: Flip ON/OFF switch to the "ON" position.
For international machines: Push the green start button.
5. Move handles forward or backward to move machine forward or in reverse.

Stopping the Machine

- For domestic machines: Flip ON/OFF switch to the "OFF" position to turn off.
- For international machines: Push the red stop button.

SPEED CONTROL

- Speed control knob can be adjusted while machine is running.
- Turning speed control knob counterclockwise will increase maximum forward speed (Figure 10).
- Turning speed control knob clockwise will decrease maximum forward speed (Figure 10).

ADDING/REMOVING SLIDE WEIGHTS (OPTIONAL)

To move the side slide weight forward/back, unscrew bolt and gently shift the weight to the desired location. After moving each side slide weight to this position, screw bolt back into place.

TYPES OF APPLICATIONS

VCT Tile: Never use a blade wider than the size of the tile being removed. If material still does not come up clean or machine jumps on top of material, reduce blade size or use a smaller portion of the blade.

Pure Vinyl Rubber Tile: Material will need to be scored down to 10-12" (25.4-30.5 cm) for proper removal. Self-scoring blades can be used with some materials. A 10" (25.4 cm) blade is recommended for this application.

Ceramic: Carbide shanks are most effective for removing ceramic. On small block-styles of tile, pre-breaking may not be necessary. Open an area large enough for machine or blade to fit in, or start from a doorway. Use slow speed.

Direct-Glued Carpet: Can be done with either self-scoring blades or if the carpet is pre-scored prior to stripping. Pre-scored carpet makes machine easier to control and helps blades to stay sharper longer. Blades up to 16" wide can be used. Normally, 12-14" (30.5-35.5 cm) blades are used on direct-glued carpet, secondary backed, unitary, double glued, vinyl foam, and urethane foam. Latex foams usually come up easier with a 16" (40.6 cm) blade.

Wood: Wood Floor Shank (#7082-8) was specifically designed to use on the 6280HD Gladiator and will usually work best. In most instances it is necessary to pre-score the wood floor every 6-8" (15.2-20.3 cm), 90% through the floor, in a cross-grain fashion. Use the 9-degree angle attachment (#402276) to keep the shank low to the floor. Using the machine on a slow speed will help.

Thin Coatings: Use razor blades with a razor blade cutting head or a carbide shank. Experiment to see which method works the best for the job application.

Re-scrape: Use razor blades with a razor blade cutting head or a .062 standard blade. Experiment to see which method works the best for the job application. Use a sharper angle of attack if necessary.

Subfloor Surfaces

Glued Hardwood Flooring: A 10" (25.4 cm) blade is recommended for regular adhesive; a 6" (15.25 cm) blade for epoxy. For proper removal of hardwood flooring (plank solid, plank laminated, parkay laminated), flooring must be scored to blade width. This is done by using a circular saw set at a depth of 99% of the thickness of the board, just missing the subfloor surface when on concrete (Figure 11). A chalk line for scoring lines can be used across the floor the width of the blade (Figure 12). A ripping guide attached to the saw can be used to eliminate chalk line marks. For true parkay flooring, scoring is not necessary. It will come up in small pieces. Open an area large enough to fit machine or start from a doorway.

Wood: When working over plywood sub-flooring, run machine in the same direction as the grain in the wood. Blade works best bevel down. On solid wood floors (e.g. plank), run in the same direction as the plank, not perpendicular to grain or plank. Removing the front counter weight(s) will help on all soft surfaces.

Concrete: For best performance, position blade bevel up when working on a concrete slab or cleaning adhesive. On occasion, bevel down gives better blade life. Test each job for best performance.

Gypcrete and Soft-Poured Flooring: Position blade bevel down to create a better wearing surface, although bevel up may work if front counter weight is removed.

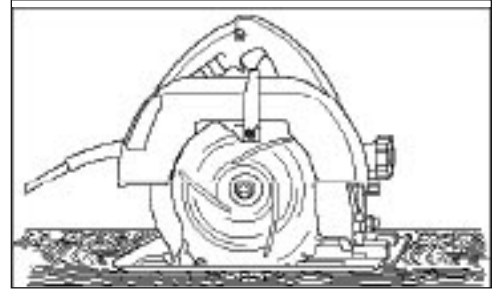

FIG. 11

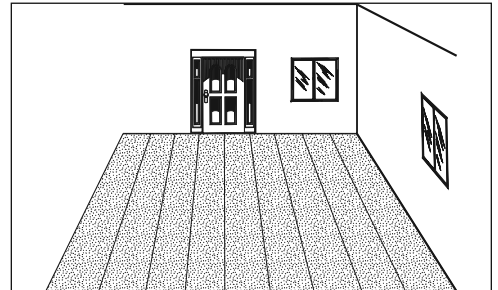

FIG. 12

Troubleshooting Guide

Problem	Cause	Solution
Machine will not start.	Insufficient power.	Ensure use of properly rated extension cord.
	Loose capacitor leads.	Check capacitor leads to ensure good connection.
	Overload button on motor has been tripped.	Button is located on the bottom of the electric box on motor. If tripped, hold button in until it clicks.
	Faulty ON/OFF switch.	Replace if needed.
Machine will not move under power.	Wheels are not in the "engage mode."	Install wheel pins for "engage mode."
	Broken belt.	Remove wheels and bottom cover to inspect. Replace if needed.
	Broken chain.	Remove wheels and bottom cover to inspect; repair or replace if needed.
	Control handle mechanism failure.	Inspect control mechanism; repair or replace as needed.
Motor is humming, but machine does not run or breakers are blown.	Failed isolators.	Remove wheels and bottom cover to inspect.
	Failed capacitors.	Replace as needed.
	Motor start switch connections are dirty.	Remove fan cover and fan. Clean the motor start switch (set of points) with an emery board or cloth between the points; reassemble.
Machine is leaking hydraulic fluid.	Leak in hose(s).	Tighten; replace if needed.
	Hydraulic fittings are loose.	Tighten; replace if needed.
Motor is heating up.	Motor shaft is binding.	Remove wheels and cover to inspect isolators. Inspect cutting head bearing and eccentric to ensure that they are not binding. If issue continues, contact NFE for additional support.
Machine won't propel forward, only in reverse.	Speed control is set too slow.	Turn speed control knob to the left (counterclockwise).
Shank doesn't fit into angle attachment.	Burrs inside angle attachment.	Use round file until burrs are gone.
	Damage to shank insert end.	Remove damage with file or hand grinder. Replace shank if necessary.

Note: For additional maintenance and repair information, reference this machine's Service Manual.

Warranty

National Flooring Equipment Inc. (referred to as "the Company") warrants that each new unit manufactured by The Company, to be free from defects in material and workmanship in normal use and service for a period of twelve (12) months from date of shipment from the Company. For administrative ease, will honor warranty for a period of fifteen (15) months from date of shipment from the company. Accessories or equipment furnished and installed on the product by the Company but manufactured by others, including but not limited to: engines, motors, electrical components, transmissions etc., shall carry the accessory manufacturers own warranty. Battery warranties are prorated over the warranty period. Customer is responsible for the inspection of equipment / parts upon delivery. Freight damages reported beyond authorized time frame will not be honored.

The Company, at its determination of defect, will repair or replace any product or part deemed to be defective in material or workmanship within specified warranty time period. All product determinations and / or repairs will take place at the designated Company repair facility, or at a certified warranty location designated by the Company. The Company will coordinate and be responsible for all freight expenses associated with valid warranty claims. Freight and shipping expenses associated with abuse or misuse will be back charged to the Distributor/Customer. The Company reserves the right to modify, alter or improve any part / parts without incurring any obligation to replace any part / parts previously sold without such modified, altered or improved part / parts. In no event shall the seller or manufacturer of the product be liable for special, incidental, or consequential damages, including loss of profits, whether or not caused by or resulting from the negligence of seller and / or the manufacturer of the product unless specifically provided herein. This warranty shall not apply to any products or portions there of which have been subjected to abuse, misuse, improper installation or operation, lack of recommended maintenance, electrical failure or abnormal conditions and to products which have been tampered with, altered, modified, repaired, reworked by anyone not approved or authorized by the Company or used in any manner inconsistent with the provisions of the above or any instructions or specifications provided with or for the product. Any and all unauthorized onsite warranty work conducted by unauthorized personnel or any outside person(s), is not covered by the Company unless the work has been pre-authorized by a predetermined manufacturer representative. This excludes wearable parts and/or consumables.

Defective or failed material or equipment shall be held at the purchaser's premises until authorization has been granted by the Company to return or dispose of defective products. Products returned for final inspection must be returned with a manufacturer authorized Return Material Authorization (RMA). Any unauthorized return of equipment will be declined at the dock by the Company. Any non-approved items returned with approved returned items are subject to rejection and will not be credited. Credit will be issued for material found to be defective upon the Company's inspection based on prices at time of purchase.

TO OBTAIN SERVICE CONTACT NATIONAL FLOORING EQUIPMENT, INC. TOLL FREE AT 800-245-0267 FOR A REPAIR AUTHORIZATION NUMBER. COD FREIGHT RETURNS WILL NOT BE ACCEPTED. FREIGHT COLLECT SHIPMENTS WILL NOT BE ACCEPTED. WARRANTY REPAIRS MUST BE ACCOMPANIED BY DATE OF PURCHASE RECEIPT AND A RETURN/ REPAIR AUTHORIZATION NUMBER.

RETURN/REPAIR AUTHORIZATION NUMBER: _____

MACHINE SERIAL NUMBER: _____



Made in America Since 1968

9250 Xylon Avenue N • Minneapolis, MN 55445 • U.S.A.
Toll-free 800-245-0267 • Phone 763-315-5300 • Fax 800-648-7124 • Fax 763-535-8255
Web Site: www.nationalequipment.com • E-Mail: info@nationalequipment.com