

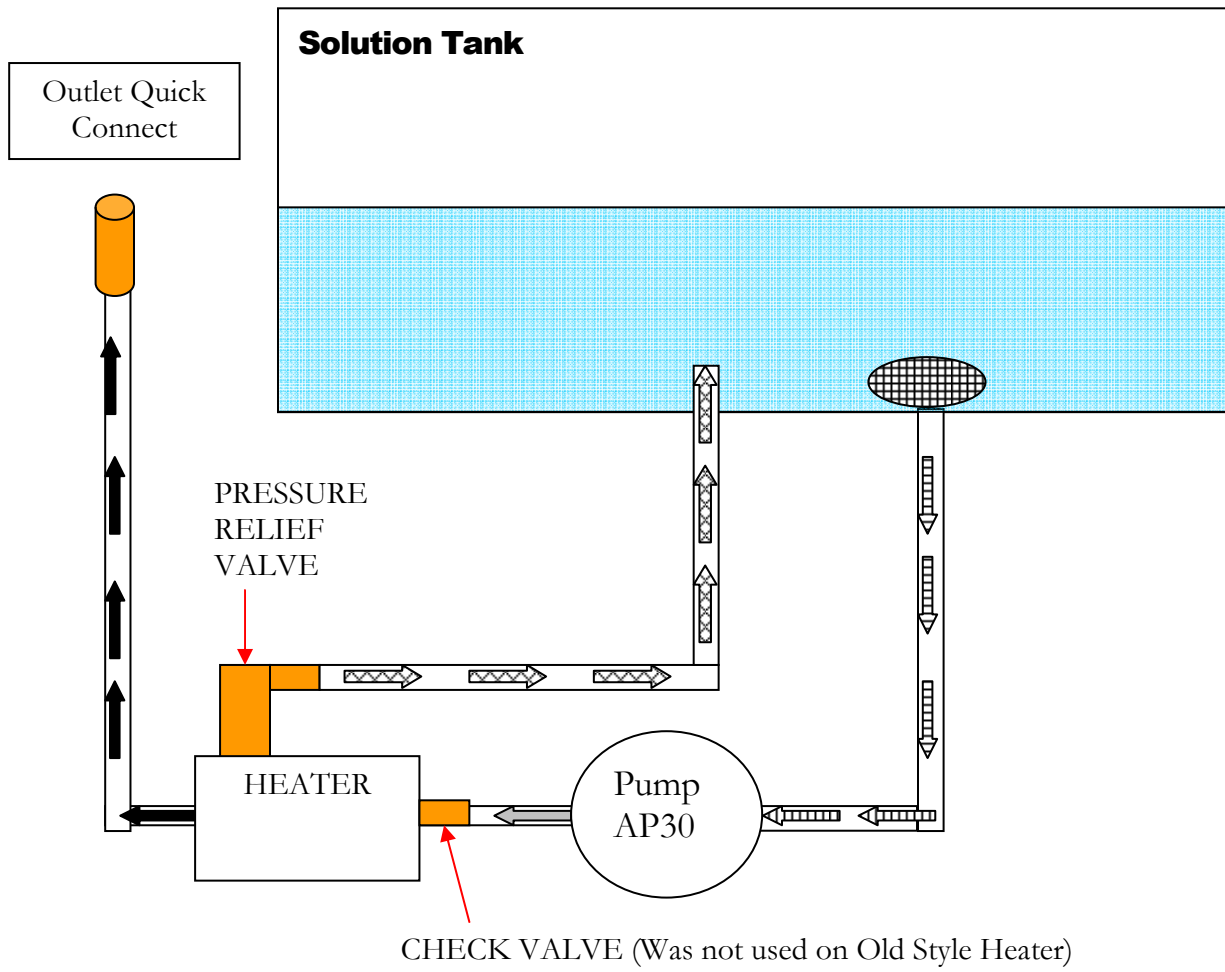

# MA51H

## Solution Flow Path



Denotes incoming water flow



Denotes Cold Water flow in pressure hose



Denotes Heated Water flow in pressure hose



Denotes Heated Water by-pass flow from heater pressure relief



# MA51H

## Wiring Diagram with Heater

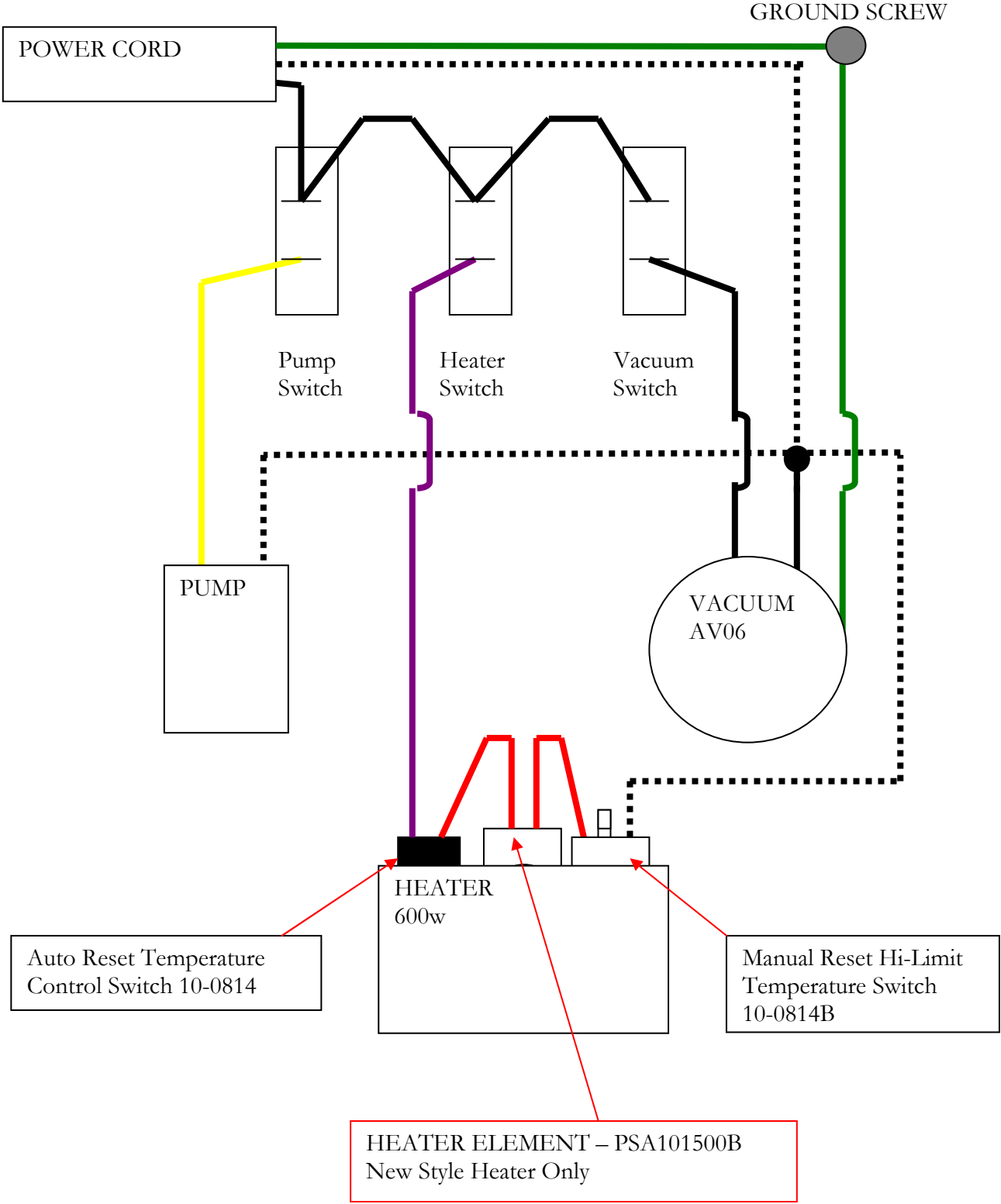

# MA51H with HEATER SWITCH PANEL:

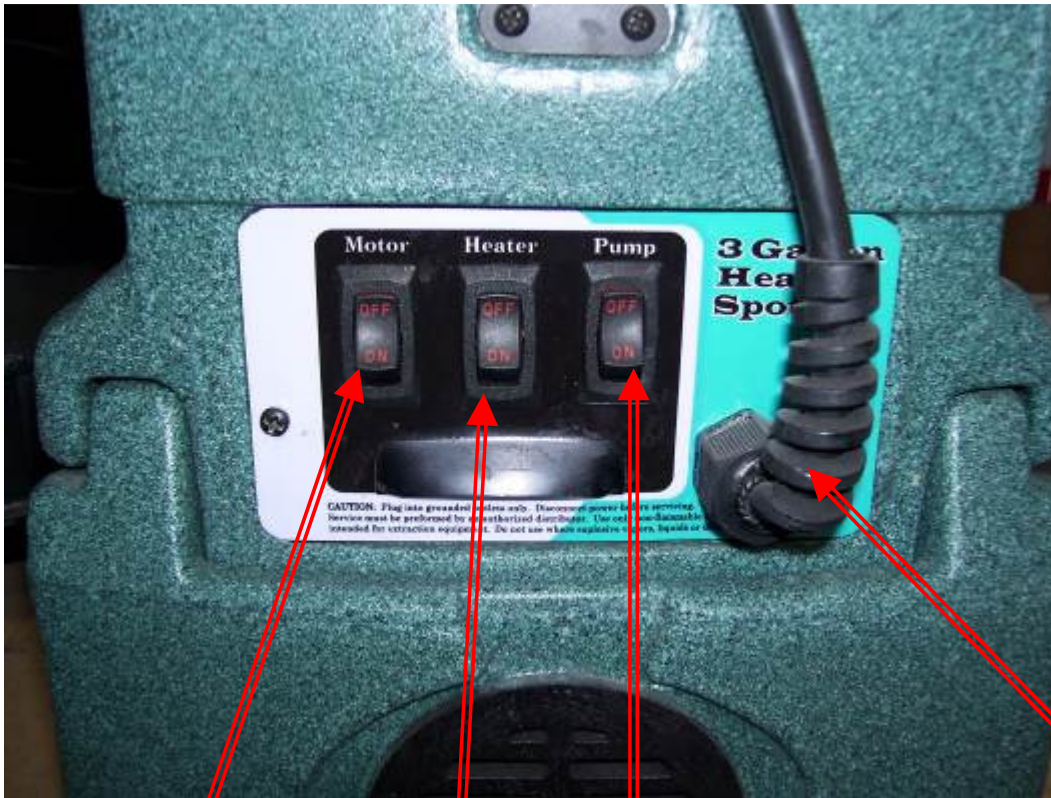

## Vacuum Switch

When the switch is turned to the ON position power is supplied to the vacuum motor only.

## Solution Pump Switch

When the switch is turned to the ON position power is supplied to the solution pump motor only.

When not using solution (Extracting only), do not turn this switch ON.

## Heater Switch

When the switch is turned to the ON position power is supplied to the solution heater only. Always turn pump switch on first and be sure water is flowing to the tool before turning heater ON.

Turn heater off and spray tool for a minute to cool off heater before turning pump off.

When not using solution (Extracting only), do not turn this switch ON.

## Power Cord

## Parts

*Replacement parts available for repair of your Power X Pro Spot Extractor:*

### **Power X Spotter Pump – AP30**

SOLUTION INLET  
1/8" FPT

SOLUTION OUTLET  
1/8" FPT



### **Power X Spotter Vacuum Motor – AV06**



# MA51H Power X Spotter with Heater

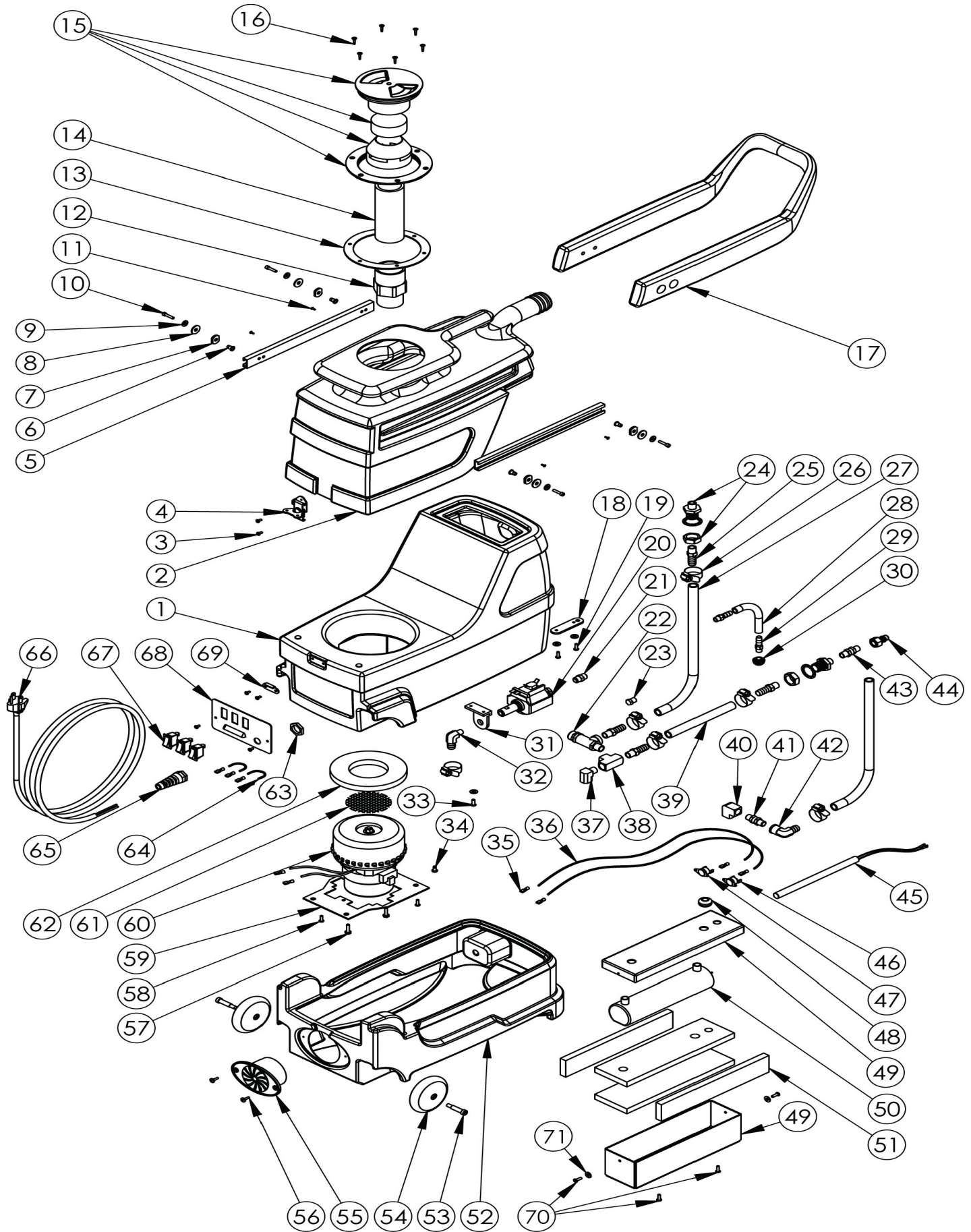

	Item #	MA51H Component Description	Qty Needed
1	NM5090-ST	Solution Tank	1
2	NM5090-RT	Recovery Tank	1
3	10-0383	6/32 x ¼ Phil Pan Blk Screw (Latch & Switch Plate)	6
4	10-0400-D	Latch	1
5	10-0412	C Channel For Spotter	2
6	10-0414	Rivet For Spotter Handle	4
7	10-0384	.125 Thick Nylon Washer	4
8	10-0385	.06 Thick Nylon Washer	4
	NM5032	Flat Washer #8 SAE	5
10	10-0216	Allen Head Screw	4
11	10-0379	8-32 x 3/8" Screw	4
12	10-0405	1½" PVC SCH40 Slip Thread	1
13	10-0302-A	Gasket Tank Hatch	1
14	10-0416-A	ABS Stand Pipe Black 1½"	1
15	10-0304	Spotter Hatch, Cap, Filter and Float Assembly	1
16	10-0419	Screw For Spotter Hatch	6
17	NM5090-HANDLE	Handle - Black	1
18	10-0831	S/R Bracket	1
19	10-0832	S/R Strap Bolts	2
20	AP30	Pump For Spotter	1
21	BR070	Nipple 1/8" Hex Brass	1
22	PSA100901	Pressure Relief Valve 175psi	1
23	BR220	Brass Plug 1/8"	1
24	NM5087	Bulkhead Fitting 1/4" Brass	2
25	BR020	Barb 3/8" x 1/4" MPT Brass	4
26	PH07	Hose Clamp	6
27	10-0843	Hose 3/8" ID Black LP	1
28	10-0434	Threaded Hose for Spotter	1
29	NA0839	Barb Nylon Straight 1/8 NPT X 1/4" Barb	4
30	NA0840	1/8" Strainer for Spotter	1
31	10-0301	L Bracket For Spotter	1
32	10-0828	90 Deg Brass Elbow 1/8" MPT	1
33	10-0022	Screw	3
34	10-0017	Deflector Screw	1
35	PA076	Female Spade Connector Insulated – Blue	10
36	T-WPUR	Purple Wire	
37	BR282	Elbow 90 Deg 1/4" Street M-F	1
38	BR252	Tee 1/4" Street M-F-F	1
39	10-0843	Hose 3/8" ID Black LP – sold per inch	24"
40	BR292	Elbow 90 Deg 1/4" F-F	1
41	NM5069	Check Valve 1/4" MPT	1
42	80-0014	Elbow 90 Deg 1/4" FPT x 3/8" barb	1
43	BR082	1/4" Close Nipple Brass	1
44	AH102B	1/4" Male Quick Connect	1
45	PSA101500B	Heater – Element Only	1
46	10-0814	Temperature Switch Auto Reset	1
47	10-0814-B	Temperature Switch Manual Reset	1
48	10-0907	Strain Relief for Heater	1

	Item #	MA51H Component Description	Qty Needed
49	10-0906	Heater Box Only	1
50	10-0900	Heater Body Only	1
51	10-0801-G	Insulation for Heater Box	1
	PSA100910	Heater Assembly Complete with all Fittings & Temperature Switches	1
	PSA001	High Pressure Hose Assembly	1
52	SP-3-HS-GRNGRAN	Base Spotter Skirt w/ Heat	1
53	10-0387	5/16 x 1" Socket Head Bolt (For Wheels)	2
54	10-0303	Roller Blade Wheel	2
55	10-0822	Exhaust Grate	2
56	10-0419-A	Screw For Exhaust Grate	2
57	10-0014	Motor Screws	2
58	10-0380	Screw 10-32 x 3/8"	2
59	10-1024	Vac Motor Mounting Plate	1
60	AV06	Vacuum Motor	1
61	10-0386	Stamped Motor Screen	1
63	PS10-1030	Spotter Motor Gasket	1
64	10-0027-A	Strain Relief Nut For Spotter	1
	T-WBLA	Black Wire	
65	10-0027	Pigtail Strain Relief Spotter	1
66	10-0448-B	20 Ft. Spotter/Air Mover Cord	1
67	PDR101	On/Off Rocker Switch	3
68	10-1026	Back Switch Plate (with heater)	1
69	10-0400-C	Latch Keeper 10-0400-C	1
70	NM4061	Screw 10-32 x 1/2" BH SOC SS	3
71	NM4255	Washer Flat #10 SS	2
	NM4081	NUT 10-32 NYLOCK SS	1

# MA51H



SPOTTER HATCH COVER  
WITH FILTER  
BOTTOM VIEW  
(Part of 10-0304 Assembly)



SPOTTER HATCH, COVER,  
FILTER & FLOAT ASSEMBLY  
10-0304  
GASKET – 10-0302-A  
SCREWS – 10-0419 (QTY 6)

SPOTTER HANDLE - BLACK  
NM5090-HANDLE

SOLUTION TANK  
NM5090-ST



RECOVERY TANK  
NM5090-RT

SPOTTER BASE W/ HEAT  
SP-3-HS-GRNGRAN



# MA51H

SOLUTION TANK  
NM5090-ST

RECOVERY TANK  
NM5090-RT

POWER CORD  
10-00448-B

LATCH  
10-0400-D

SCREWS  
10-0383 (QTY 2)

LATCH KEEPER  
10-0400-C

SCREWS  
10-0383 (QTY 2)

SWITCH  
PDRI01

GROUND SCREW  
NM4061

NUT  
NM4081

3 Gallon Heated Spotter

Motor Heater Pump

OFF ON OFF ON OFF ON

CAUTION: Plug into grounded outlets only. Disconnect power before servicing. Service must be performed by an authorized technician. Use only non-flammable cleaning fluids for extraction equipment. Do not use above explosive vapors, liquids or dust.

SCREW 6-32 X 1/4"  
10-0383

STRAIN RELIEF  
10-0027  
NUT 10-0027-A

MA51H BACK / SWITCH PLATE  
10-1026

SPOTTER BASE MA51H  
SP-3-HS-GRNGRAN

VENT GRATE  
SCREWS 10-0419-A (QTY 2)

WHEELS (QTY 2)  
10-0303  
SCREWS - 10-0387

# MA51H

SCREW VAC MOTOR MOUNT (QTY 2)  
10-0014

HOSE 3/8" ID HI-TEMP BLACK

PUMP  
AP30

1/8" HEX NIPPLE  
BR070

BARB 3/8" X 1/4" MPT  
BR020

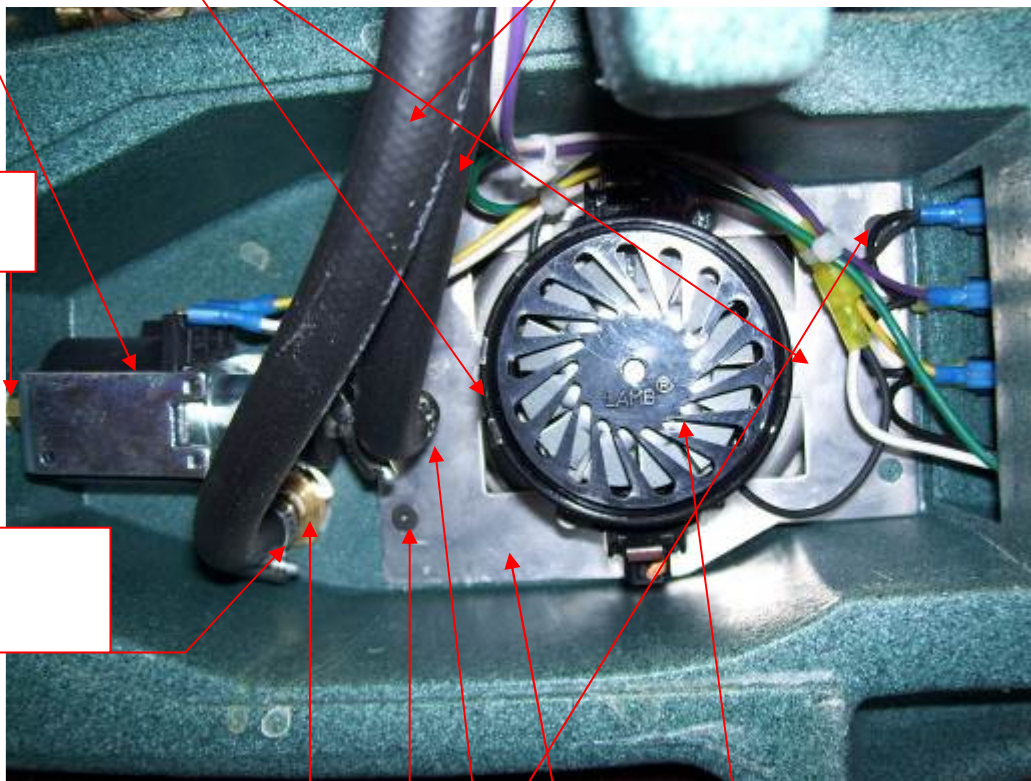

BULKHEAD FITTING 1/4"  
NM5087

VACUUM MOTOR  
AV06

SCREW VAC MOUNT PLATE (QTY 2)  
10-0380

PLATE VAC MOTOR MOUNT  
10-1024

90 DEGREE BRASS ELBOW 3/8" BARB X 1/8" MPT  
10-0828

VACUUM GASKET  
PS10-1030

SOLUTION TANK  
NM5090-ST

VACUUM SCREEN  
10-0386

VACUUM MOTOR  
AV06

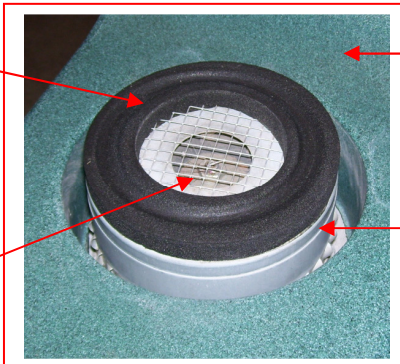

# MA51H New Heater Assembly

Heater is secured to Spotter Base with two screws & Flat Washers:  
 2 - SCREW 10-32 x 1/2" BH SOC SS – NM4061  
 2 – WASHER FLAT #10 SS – NM4255

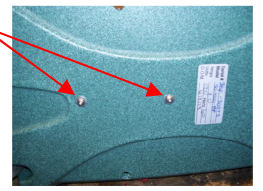

HOSE HP 1/4" ID HI-TEMP BLUE  
 1/4" JIC FITTINGS – PSA001

HOSE LP 3/8" ID HI-TEMP BLACK  
 10-0843 (Sold per inch)

BARB 3/8" X 1/4" MPT  
 BR020

ADAPTER 1/4" MPT X 1/4" T M FLARE  
 BR126

PRESSURE RELIEF VALVE  
 PSA100901

CHECK VALVE 1/4" MPT  
 NM5069

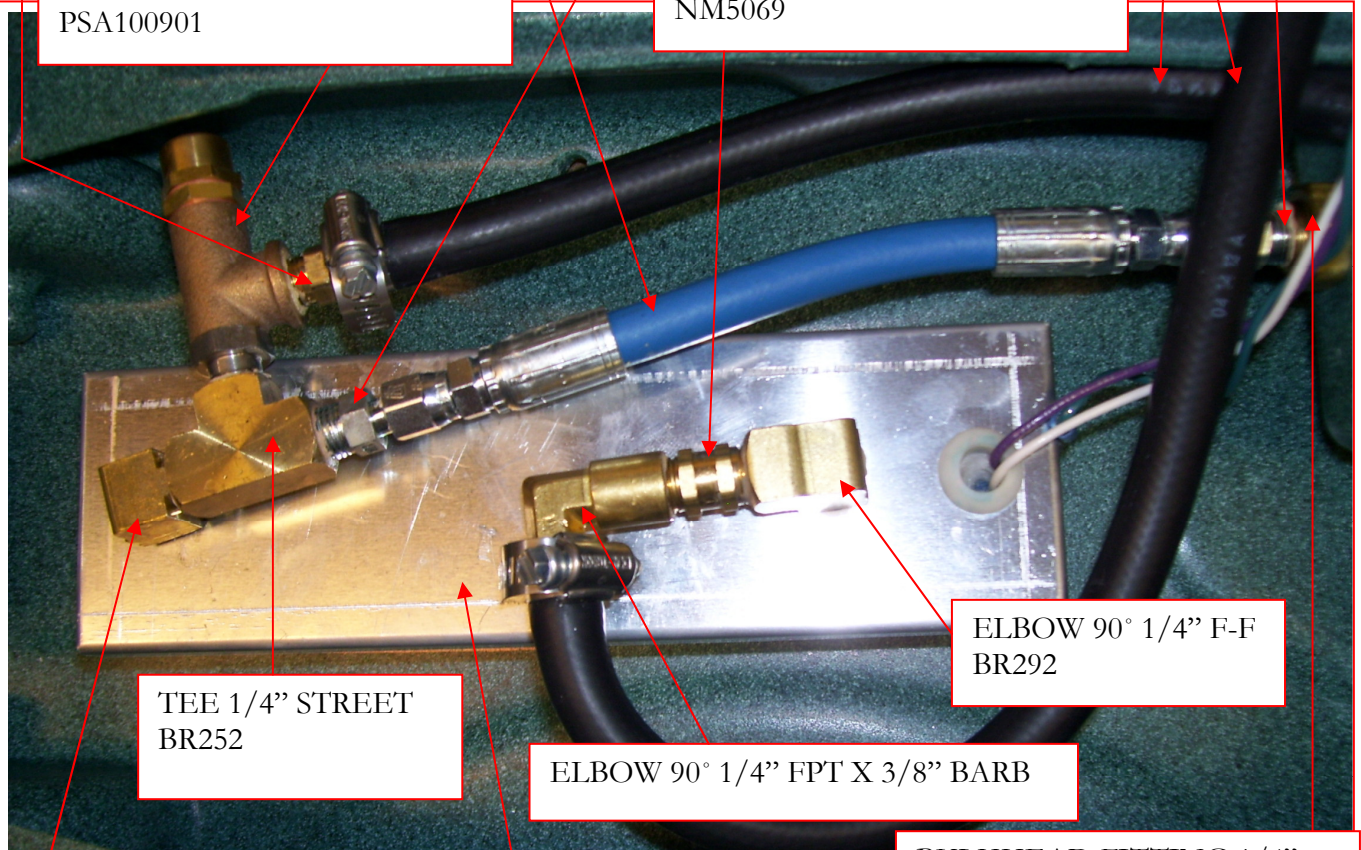

TEE 1/4" STREET  
 BR252

ELBOW 90° 1/4" F-F  
 BR292

ELBOW 90° 1/4" FPT X 3/8" BARB

ELBOW 90° 1/4" STREET  
 BR282

HEATER 600W  
 PSA100910  
 COMPLETE WITH FITTINGS

BULKHEAD FITTING 1/4"  
 NM5087

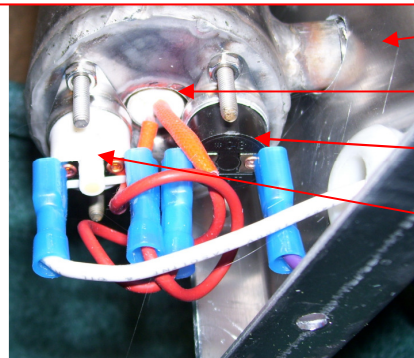

HEATER OUTER SHELL ONLY – PSA100900

HEATER ELEMENT ONLY – PSA101500B

TEMPERATURE SWITCH AUTO RESET  
 10-0814

TEMPERATURE SWITCH MANUAL RESET  
 10-0814-B

# MA51H Old Style Heater

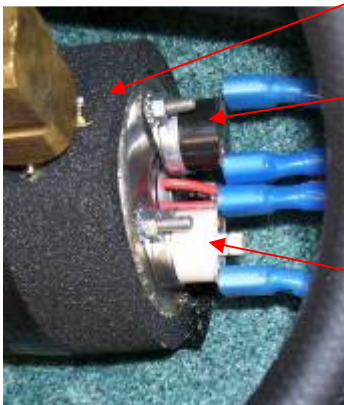
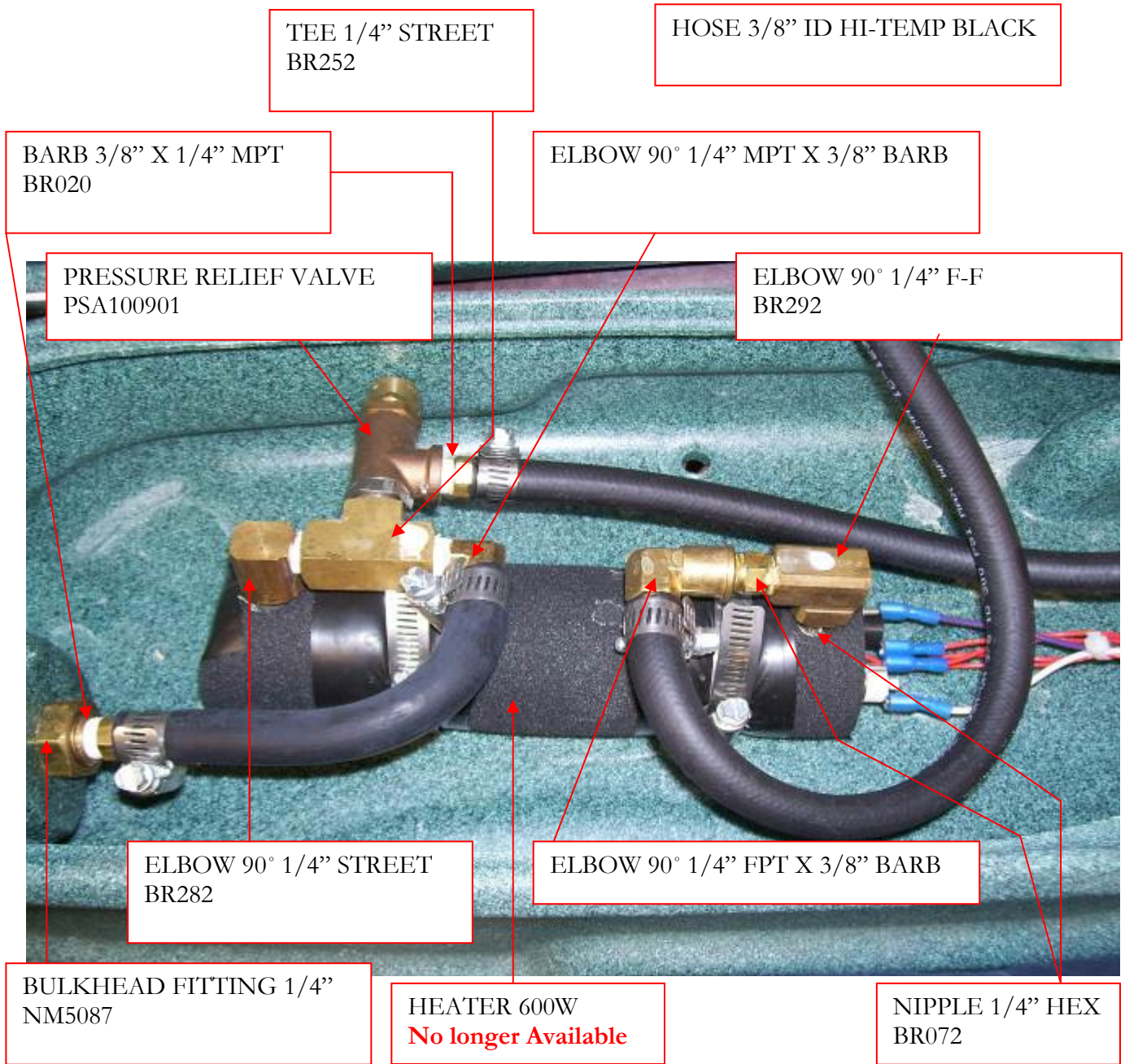

TEMPERATURE SWITCH AUTO RESET  
10-0814-B

TEMPERATURE SWITCH MANUAL RESET  
10-0814

# MA51H

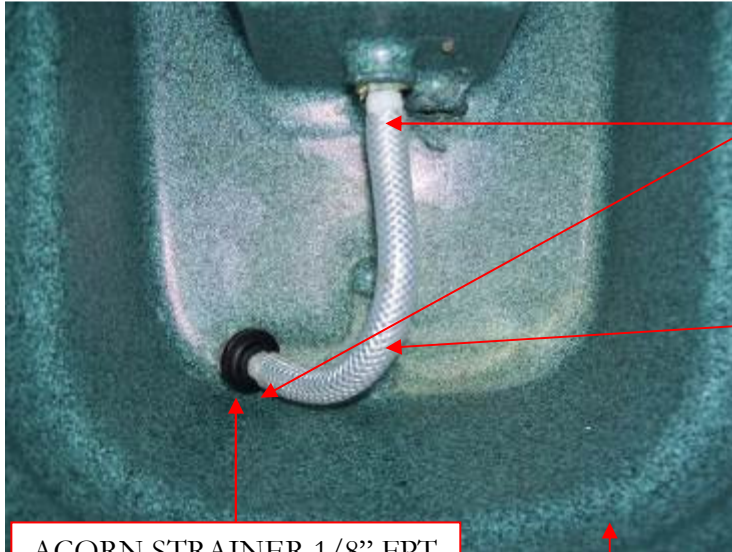

BARB 1/4" X 1/8" MPT  
NA0839

1/4" ID HOSE  
10-0434

ACORN STRAINER 1/8" FPT  
NA0840

RECOVERY TANK  
NM5090-RT

SOLUTION TANK  
NM5090-ST

SPOTTER BASE MA51H  
SP-3-HS-GRNGRAN



BULKHEAD FITTING 1/4"  
NM5087

NIPPLE 1/4" HEX  
BR072

1/4" MALE QUICK CONNECT  
AH102B

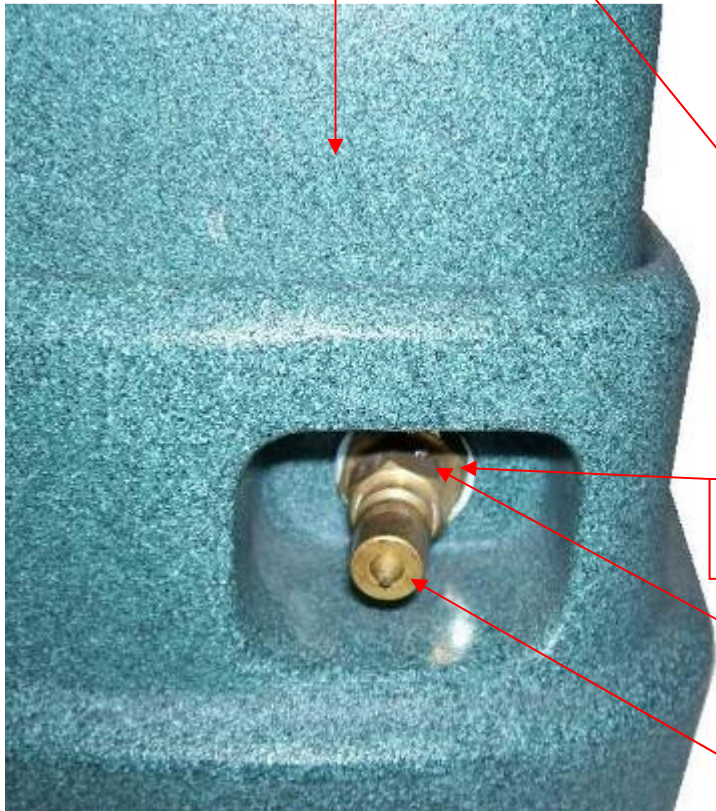

## AW55H HOSE & TOOL ASSEMBLY

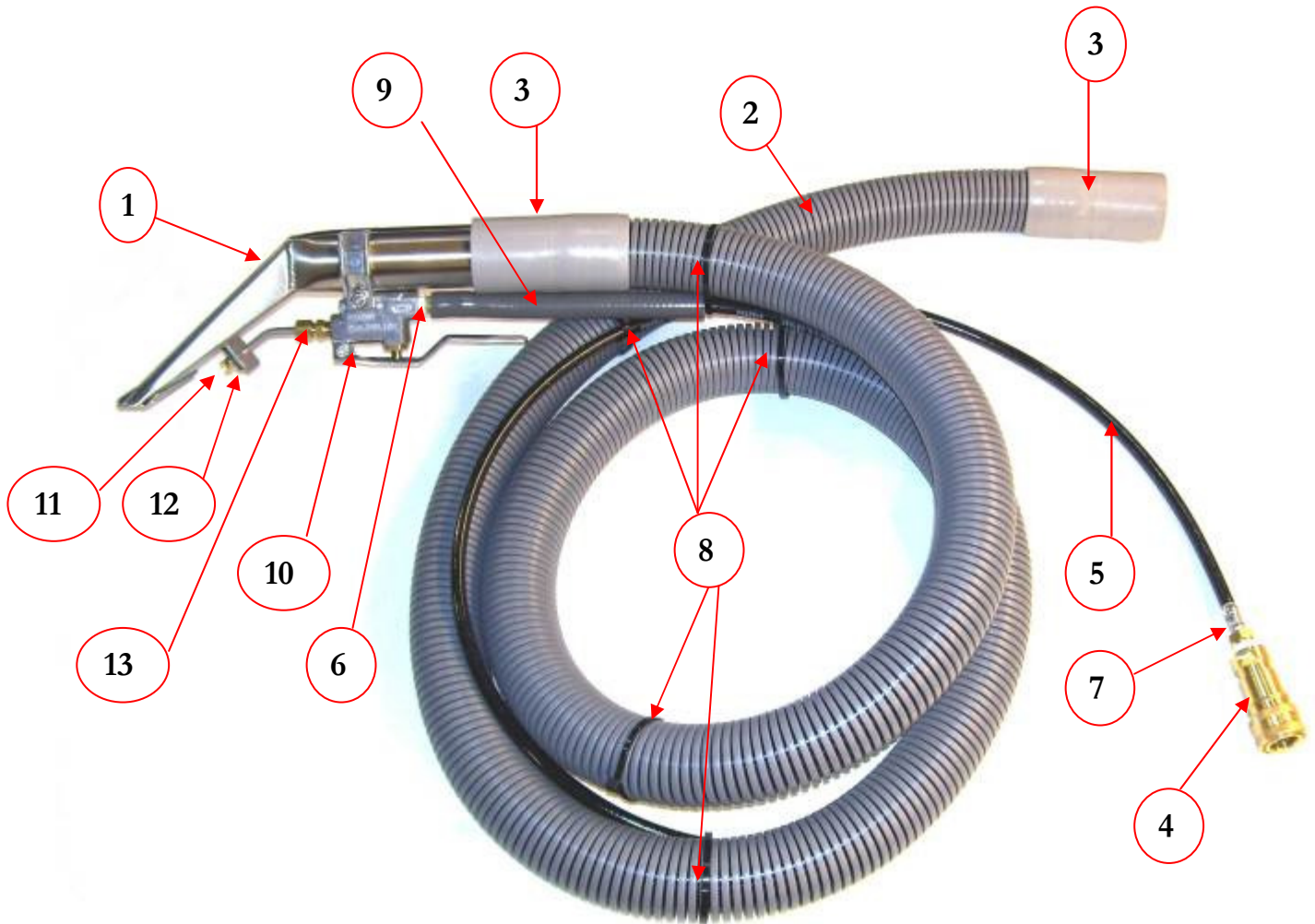

	ITEM#	Description	QTY
1	PA205	3.5" SS Upholstery Tool	1
2	AH35	1-1/4" Gray Vacuum Hose (Sold per foot)	7'
3	PP08-805088	1-1/4" Hose Cuff	2
4	AH101B	1/4" QD Female	1
5	NA40A	3/16" HP Black Solution Hose (Sold per Inch)	96"
6	AH01	1/8" Hose End for 3/16" hose	1
7	AH02	1/4" Hose End for 3/16" hose	1
8	100003	Wire Tie Black 7"	5
9	AH90	3/8" LP Gray Solution Hose (Sold per foot)	0.5
10	PMV124V5	Solution Valve with lever & mounting bracket	1
11	PMF8002	Tee Jet for hand tool 8002	1
12	PMF011	Retaining Plate for jet on hand tool	1
13	BR304	Compression fitting 1/8" MPT	1
NS	PMV124V5B	Valve Repair Kit	1