

**SPECIFICATIONS**

- Undermount
- 18/8 chrome nickel content
- 10mm radius corners
- Pro-Vest undercoat protection over Sound Shield pads
- Template and mounting hardware included
- Satin finish - Fits 36" cabinet
- 3 1/2" drain opening

**18 Gauge™**  
304 Premium Stainless Steel

**SINK FEATURES**



HIVE sinks feature Sound-Shield pads on several strategic areas of every sink for extra sound proofing. Made of natural rubber, the Sound-Shield pads reduce the noise of clattering dishes and running water.



Pro Vest is a protective coating over the Sound-Shield pads. This system reduces noise, prevents condensation and helps maintaining water temperature when pre-soaking dishes.

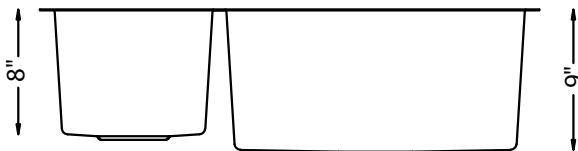
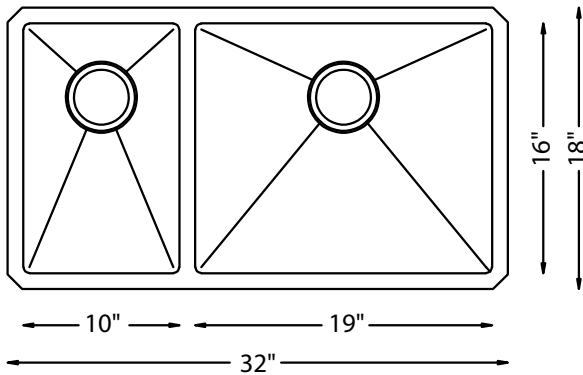

All HIVE sinks receive expert hands-on care under strict quality control throughout every stage of our modern manufacturing process. This ensures a "NO HASSLE" Limited Lifetime Warranty against all manufacturing defects in material and workmanship under normal use.

**CODE / STANDARDS COMPLIANCE**

Most HIVE sinks meet or exceed the following specifications:  
ASME 112.19.3-2008 - IAPMO/UPC listed - CSA B45.4-2008

**JOB INFORMATION**

JOB NAME: \_\_\_\_\_

MODEL SPECIFIED: \_\_\_\_\_ QUANTITY: \_\_\_\_\_

DATE: \_\_\_\_\_

ARCHITECT/ENGINEER: \_\_\_\_\_

CUSTOMER: \_\_\_\_\_

CONTRACTOR: \_\_\_\_\_