

SIS-GR201B-01 1671-6084 Black Sand	SIS-GR201B-02 1672-6085 Wheat	SIS-GR201B-03 1673-6086 Iceberg	SIS-GR201B-04 1674-6087 Grey Moon	SIS-GR201B-05 1675-6088 Chocolate	SIS-GR201B-06 1699-9512 Silver Fox	SIS-GR201B-07 1690-9614 Storm Cloud	SIS-GR201B-08 1691-9615 Eclipse

1-3/4 Double Bowl Granite Sink

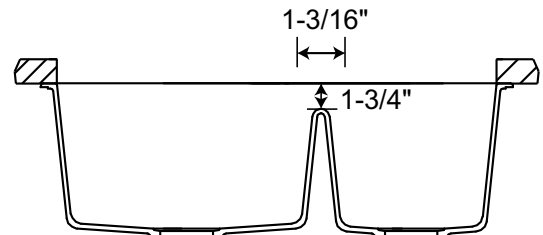

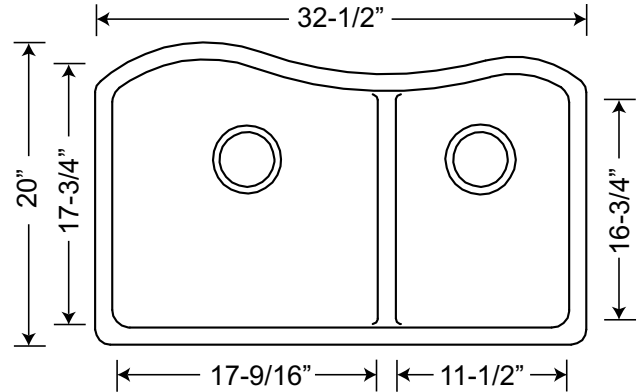



Depth = 10" / 10"

SIS-GR201B - DURAGRANIT SERIES

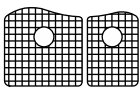
- 80% quartz and 20% acrylic resins
- Undermount installation
- Scratch and stain resistant
- Heat and acid resistant
- Non-fading
- Easy to clean, extremely hygienic
- Suitable for food preparation
- Fits 36" cabinet
- 3 1/2" drain opening

AVAILABLE ACCESSORIES

			
SIS-G-GR201B Stainless Steel Grid	SIS-S01- <input type="checkbox"/> Basket Strainer	SIS-S06- <input type="checkbox"/> Disposal Flange	SIS-GCB1709 Glass Cutting Board
QTY <input type="checkbox"/>	QTY <input type="checkbox"/>	QTY <input type="checkbox"/>	QTY <input type="checkbox"/>

CODE / STANDARDS COMPLIANCE

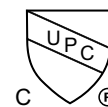

Sinks are listed by IAPMO® as meeting the applicable requirements of the Uniform Plumbing Code®, International Plumbing Code®, and National Plumbing Code of Canada. Product Compliance: CSA B45.5-11/IAPMO Z124-201 including Update No. 1 dated May 2012

JOB INFORMATION

JOB NAME: _____ **MODEL SPECIFIED:** _____ **QUANTITY:** _____

DATE: _____ **ARCHITECT/ENGINEER:** _____

CUSTOMER: _____ **CONTRACTOR:** _____