



Instructions for the following series products:

DELTA™ Full Body Harnesses

(See back pages for specific model numbers.)

**USER INSTRUCTION MANUAL
DELTA™ FULL BODY HARNESS**

This manual is intended to meet the Manufacturer's Instructions as required by ANSIZ359.1 and CSA 259.10-06 and should be used as part of an employee training program as required by OSHA



Figure 1

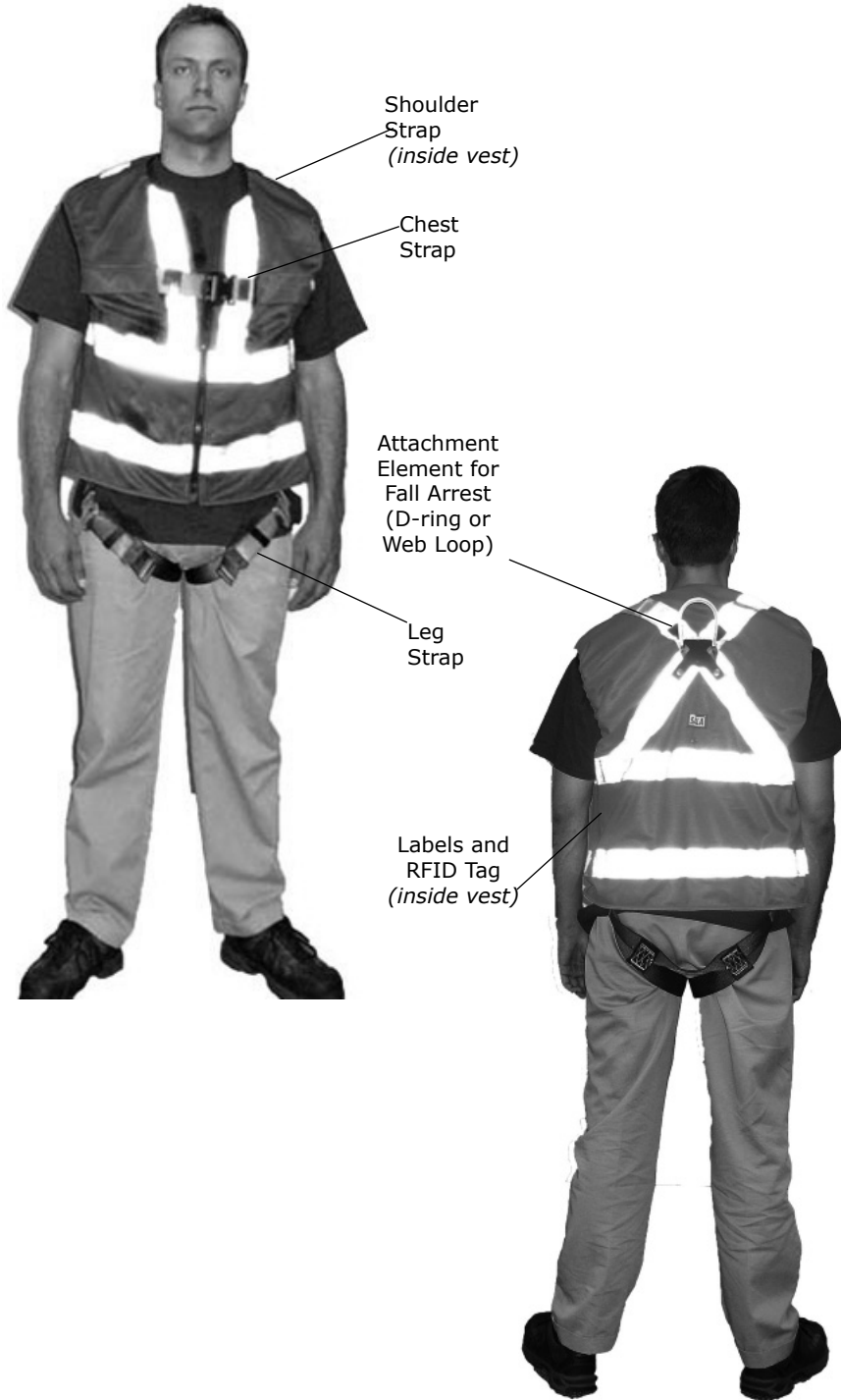

Figure 2



Figure 3



Figure 4



WARNING: This product is part of a personal fall arrest, restraint, work positioning, personnel riding, climbing, or rescue system. The user must follow the manufacturer's instructions for each component of the system. These instructions must be provided to the user of this equipment. The user must read and understand these instructions before using this equipment. Manufacturer's instructions must be followed for proper use and maintenance of this equipment. Alterations or misuse of this product or failure to follow instructions may result in serious injury or death.

IMPORTANT: If you have questions on the use, care, or suitability of this equipment for your application, contact Capital Safety.

IMPORTANT: Before using this equipment, record the product identification information from the ID label in the inspection and maintenance log of this manual.

DESCRIPTIONS

Delta Vest™ Full Body Harness: See Figure 1.

Vest Style Full Body Harness: See Figure 2.

Cross-Over Style Full Body Harness: See Figure 3.

Step-In Style Full Body Harness: See Figure 4.

OPTIONS:

DBI-SALA Full Body Harnesses are available with options and accessories. Following is a partial list of commonly used options and accessories (some options may not be available on all harnesses):

- Shoulder D-rings
- Side D-rings
- Hip pad with side D-rings
- Quick Connect buckles
- Tongue buckle body belt
- Loops on harness for body belt
- Kevlar® webbing
- High visibility webbing
- Non-sparking/Non conductive PVC coated hardware
- Shoulder pads
- Tool belt support straps
- Seat sling
- Lanyard attached directly to D-ring or attachment element
- Snap fastener on shoulder strap for retaining lanyard
- Delta Vest™
- Tool holders

1.0 APPLICATIONS

1.1 PURPOSE: DBI-SALA full body harnesses are to be used as components in personal fall arrest, restraint, work positioning, or rescue systems. See Figures 1, 2, 3, and 4 for harness styles.

Harnesses included in this manual are full body harnesses and meet ANSI Z359.1, OSHA, and CSA Z259.10-06 requirements. See Figure 5 for application illustrations.

- Full body harnesses with Kevlar web should be used when working with tools, materials, or environments of high temperature (foundries, chemical manufacturing, steel fabrication, emergency rescue services, fire services, welders, oil industry, nuclear industry, explosives).
- Harnesses with PVC coated hardware should be used when working in explosive or electrically conductive environments, or where surfaces must be protected from the hardware.
- Harnesses with high visibility webbing should be used when increased visibility of the user is required.

A. PERSONAL FALL ARREST: The full body harness is used as a component of a personal fall arrest system. Personal fall arrest systems typically include a full body harness and a connecting subsystem (energy absorbing lanyard). Maximum arresting force must not exceed 1,800 lbs (8 kN). For fall protection applications connect the fall arrest subsystem (example: lanyard, SRL, energy absorber, etc.) to the D-ring or attachment element on your back, between your shoulder blades.

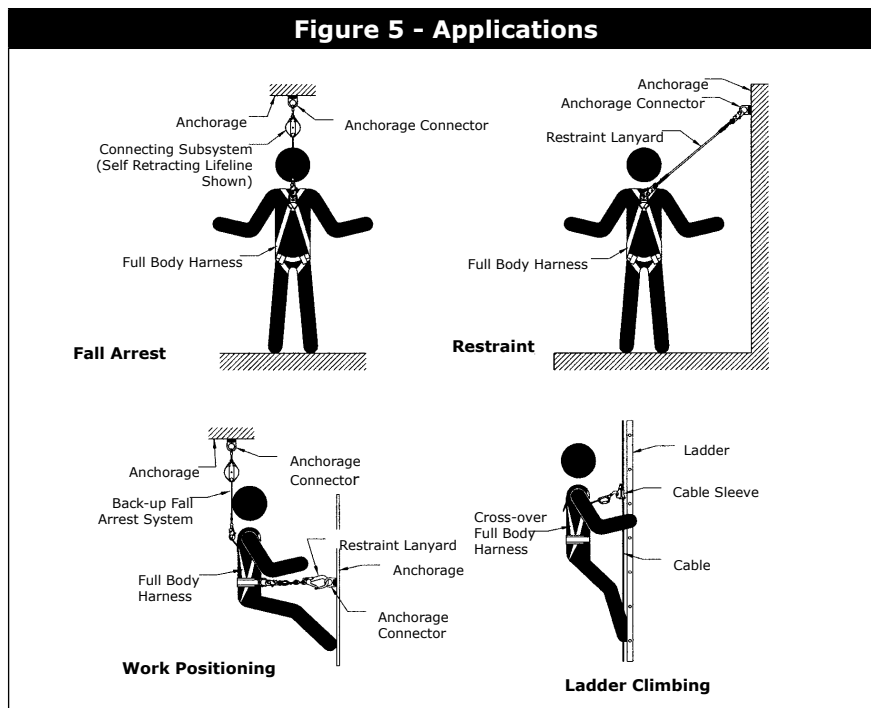

- B. WORK POSITIONING:** The full body harness is used as a component of a work positioning system to support the user at a work position. Work positioning systems typically include a full body harness, positioning lanyard, and a back-up personal fall arrest system. For work positioning applications, connect the work positioning subsystem (example: lanyard, Y-lanyard, etc.) to the lower (hip level) side or belt mounted work positioning attachment anchorage elements (D-rings). Never use these connection points for fall arrest.
- C. LADDER CLIMBING:** The full body harness is used as a component of a climbing system to prevent the user from falling when climbing a ladder or other climbing structure. Climbing systems typically include a full body harness, vertical cable or rail attached to the structure, and climbing sleeve. For ladder climbing applications, harnesses equipped with a frontal D-ring in the sternal location may be used for fall arrest on fixed ladder climbing systems. These are defined in Z259.2.1 in Canada and ANSI A14.3 in the United States.
- D. RESCUE:** The full body harness is used as a component of a rescue system. Rescue systems are configured depending on the type of rescue. For limited access (confined space) applications, harnesses equipped with D-rings on the shoulders may be used for entry and egress into confined spaces where worker profile is an issue.
- E. CONTROLLED DESCENT:** For controlled descent applications, harnesses equipped with a single sternal level D-ring, one or two frontal mounted D-rings, or a pair of connectors originating below the waist (such as a seat sling) may be used for connection to a descender or evacuation system (reference in Z259.10-06 in Canada).
- F. RESTRAINT:** The full body harness is used as a component of a restraint system to prevent the user from reaching a fall hazard. Restraint systems typically include a full body harness and a lanyard or restraint line.

1.2 LIMITATIONS: Consider the following application limitations before using this equipment:

- **CAPACITY:** These full body harnesses are designed for use by persons with a combined weight (clothing, tools, etc.) for ANSI Z359.1--310 lbs (141 kg), CSA Z259.10-06--352 lbs (160 kg). Make sure all of the components in your system are rated to a capacity appropriate to your application
- **FREE FALL:** Personal fall arrest systems used with this equipment must be rigged to limit the free fall to 6 feet (1.8 M) (ANSI Z359.1). Restraint systems must be rigged so that no vertical free fall is possible. Work positioning systems must be rigged so that free fall is limited to 2 feet (.6 m) or less. Personnel riding systems must be rigged so that no vertical free fall is possible. Climbing systems must be rigged so that free fall is limited to 18 in. (.46 m) or less. Rescue systems must be rigged so that no vertical free fall is possible. See subsystem manufacturer's instructions for more information.

Figure 6 - Fall Clearance

Figure 7 - Swing Falls

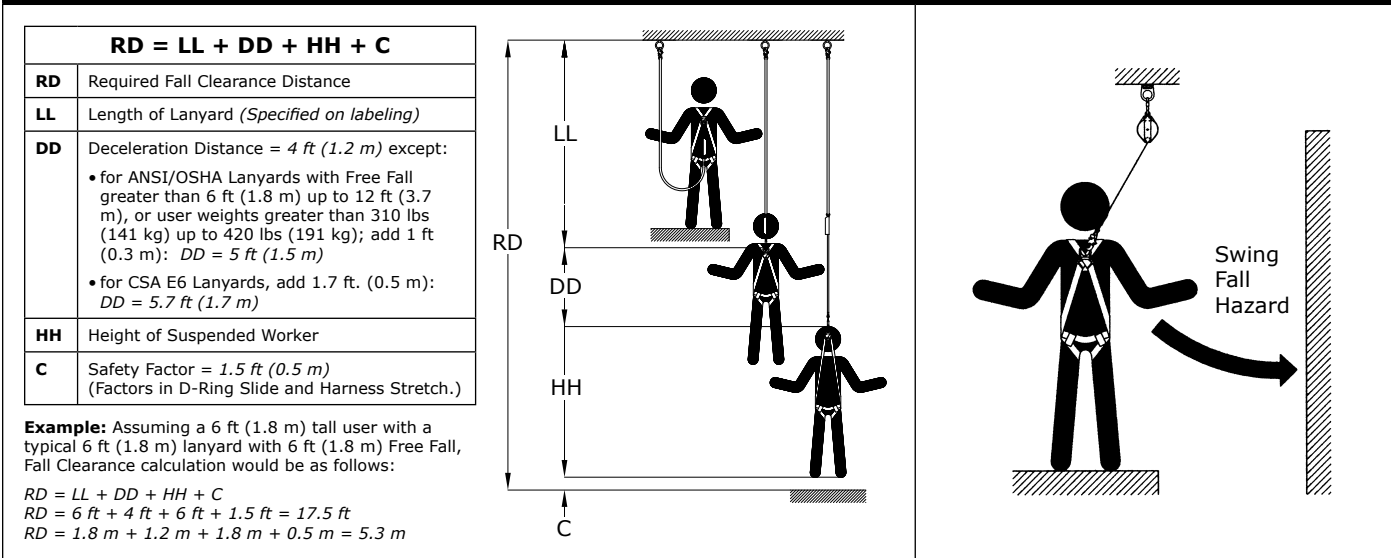

- FALL CLEARANCE:** See Figure 6. There must be sufficient clearance below the user to arrest a fall before the user strikes the ground or other obstruction. The clearance required is dependent on the following factors:

 - Elevation of Anchorage
 - Free fall distance
 - Connecting subsystem length
 - Worker height
 - Deceleration distance
 - Movement of harness attachment element

See subsystem manufacturer’s instructions for more information
- SWING FALLS:** See Figure 7. Swing falls occur when the anchorage point is not directly above the point where a fall occurs. The force of striking an object in a swing fall may cause serious injury or death. Minimize swing falls by working as close to the anchorage point as possible. Do not permit a swing fall if injury could occur. Swing falls will significantly increase the clearance required when a self- retracting lifeline or other variable length connecting subsystem is used.
- EXTENDED SUSPENSION:** A full body harness is not intended for use in extended suspension applications. If the user is going to be suspended for an extended length of time it is recommended that some form of seat support be used. DBI-SALA recommends a seat board, suspension workseat, seat sling, or a boatswain chair. Contact DBI-SALA for more information on these items.
- ENVIRONMENTAL HAZARDS:** Use of this equipment in areas with environmental hazards may require additional precautions to prevent injury to the user or damage to the equipment. Hazards may include, but are not limited to; heat, chemicals, corrosive environments, high voltage power lines, gases, moving machinery, and sharp edges.
- HARNESSES FOR HIGH TEMPERATURE ENVIRONMENTS:** Harnesses with Kevlar webbing are designed for use in high temperature environments, with limitations: Kevlar webbing begins to char at 800° to 900° Fahrenheit. Kevlar webbing can withstand limited contact exposure to temperatures up to 1,000° F. Polyester webbing loses strength at 300° to 400° F. PVC coating on hardware has a melting point of approximately 350° F.

IMPORTANT: When working with tools, materials, or in high temperature environments, ensure that associated fall protection equipment can withstand high temperatures, or provide protection for those items.

IMPORTANT: Although PVC coated, cadmium, or zinc plated hardware exhibit excellent corrosion resistance in chemical, acidic, alkaline, and atmospheric conditions, frequent inspections may be required. Consult with Capital Safety if you question the use of this equipment in hazardous environments.

- TRAINING:** This equipment must be installed and used by persons trained in its correct application and use. See section 4.0.

1.3 APPLICABLE STANDARDS: Refer to national standards, including ANSI Z359 (.0, .1, .2, .3, and .4) family of standards on fall protection, ANSI A10.32, CSA Z259.10-06, and applicable local, state and federal (OSHA) requirements governing occupational safety for more information about work positioning systems.

IMPORTANT: Harnesses with Kevlar webbing do not meet ANSI Z359.1. Kevlar does not have equivalent abrasion resistance of polyamides. Kevlar harnesses meet all other requirements of this standard.

2.0 SYSTEM REQUIREMENTS

2.1 COMPATIBILITY OF COMPONENTS: Capital Safety equipment is designed for use with Capital Safety approved components and subsystems only. Substitutions or replacements made with non-approved components or subsystems may jeopardize compatibility of equipment and may effect the safety and reliability of the complete system.

2.2 COMPATIBILITY OF CONNECTORS: Connectors are considered to be compatible with connecting elements when they have been designed to work together in such a way that their sizes and shapes do not cause their gate mechanisms to inadvertently open regardless of how they become oriented. Contact Capital Safety if you have any questions about compatibility.

Connectors (hooks, carabiners, and D-rings) must be capable of supporting at least 5,000 lbs. (22.2 kN). Connectors must be compatible with the anchorage or other system components. Do not use equipment that is not compatible. Non-compatible connectors may unintentionally disengage. See Figure 8. Connectors must be compatible in size, shape, and strength. Self-locking snap hooks and carabiners are required by ANSI Z359.1 and OSHA.

2.3 MAKING CONNECTIONS: Use only self-locking snap hooks and carabiners with this equipment. Use only connectors that are suitable to each application. Ensure all connections are compatible in size, shape and strength. Do not use equipment that is not compatible. Ensure all connectors are fully closed and locked.

Capital Safety connectors (snap hooks and carabiners) are designed to be used only as specified in each product's user's instructions. See Figure 9 for inappropriate connections. Capital Safety snap hooks and carabiners should not be connected:

To a D-ring to which another connector is attached.

- A. To a D-ring to which another connector is attached.
- B. In a manner that would result in a load on the gate.

NOTE: Large throat snap hooks should not be connected to standard size D-rings or similar objects which will result in a load on the gate if the hook or D-ring twists or rotates, unless the snap hook complies with ANSI Z359.1-2007 or ANSI Z359.12 and is equipped with a 3,600 lb (16 kN) gate. Check the marking on your snap hook to verify that it is appropriate for your application.

- C. In a false engagement, where features that protrude from the snap hook or carabiner catch on the anchor, and without visual confirmation seems to be fully engaged to the anchor point.
- D. To each other.
- E. Directly to webbing or rope lanyard or tie-back (unless the manufacturer's instructions for both the lanyard and connector specifically allows such a connection).
- F. To any object which is shaped or dimensioned such that the snap hook or carabiner will not close and lock, or that roll-out could occur.
- G. In a manner that does not allow the connector to align properly while under load.

2.4 CONNECTING SUBSYSTEMS: Connecting subsystems (self-retracting lifeline, lanyard, rope grab and lifeline, cable sleeve) must be suitable for your application. See section 1.1. See subsystem manufacturer's instructions for more information. Some harness models have web loop connection points. Do not use snap hooks to connect to web loops. Use a self-locking carabiner to connect to a web loop. Ensure the carabiner cannot cross-gate load (load against the gate rather than along the backbone of the carabiner). Some lanyards are designed to choke onto a web loop to provide a compatible connection (see Figure 10). Lanyards may be sewn directly to the web loop forming a permanent connection. Do not make multiple connections onto one web loop, unless choking two lanyards onto a properly sized web loop.

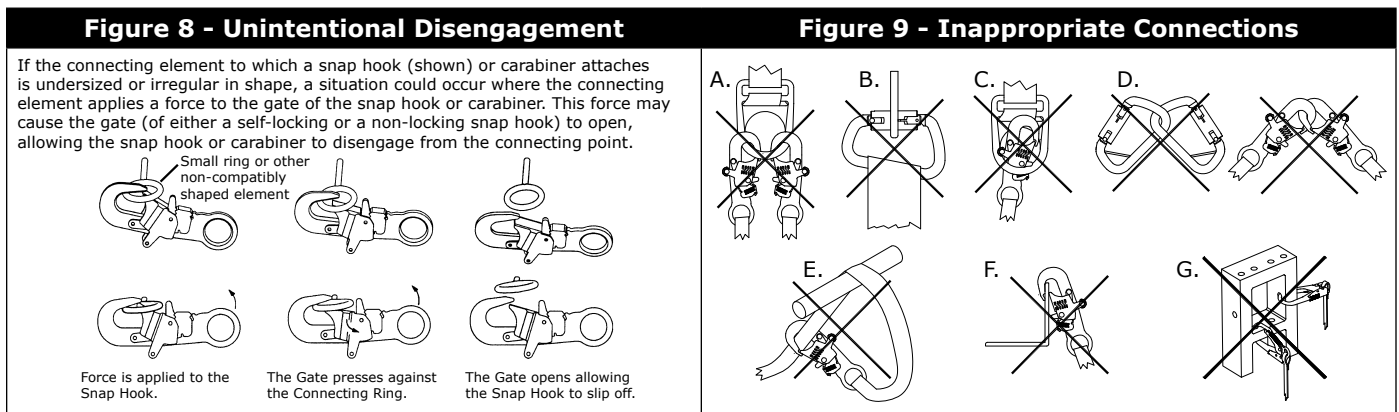
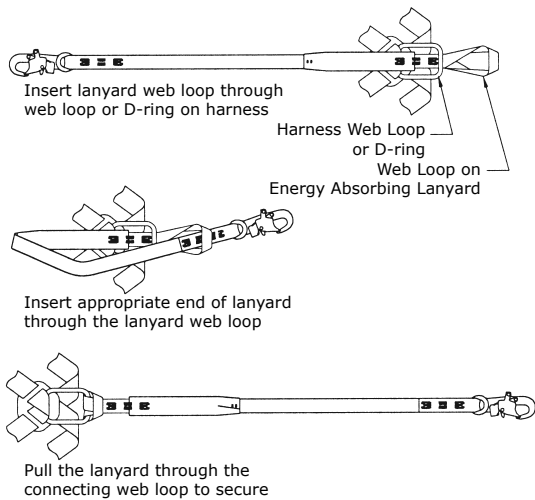
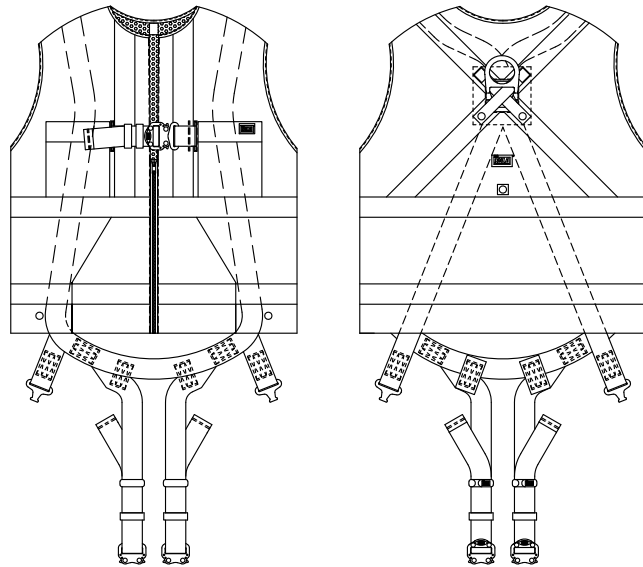

Figure 10 - Web Loop Connections**Figure 11 - Front and Back of Delta Vest™ Harness**

2.5 ANCHORAGE STRENGTH: The anchorage strength required is dependent on the application type. The following are the requirements of ANSI 359.1 for these application types:

- A. FALL ARREST:** Anchorages selected for fall arrest systems shall have a strength capable of sustaining static loads applied in the directions permitted by the system of at least:
 1. 5,000 lbs. (22.2 kN) for non-certified anchorages, or
 2. Two times the maximum arresting force for certified anchorages. When more than one fall arrest system is attached to an anchorage, the strengths set forth in (1) and (2) above shall be multiplied by the number of systems attached to the anchorage.
- B. RESTRAINT:** Anchorages selected for restraint and travel restraint systems shall have a strength capable of sustaining static loads applied in the directions permitted by the system of at least:
 1. 1,000 lbs. (4.5 kN) for non-certified anchorages, or
 2. Two times the foreseeable force for certified anchorages. When more than one restraint and travel restraint system is attached to an anchorage, the strengths set forth in (1) and (2) above shall be multiplied by the number of systems attached to the anchorage.
- C. WORKING POSITIONING:** Anchorages selected for work positioning systems shall have a strength capable of sustaining static loads applied in the directions permitted by the system of at least:
 1. 3,000 lbs. (13.3 kN) for non-certified anchorages, or
 2. Two times the foreseeable force for certified anchorages. When more than one work positioning system is attached to an anchorage, the strengths set forth in (1) and (2) above shall be multiplied by the number of systems attached to the anchorage.
- D. RESCUE:** Anchorages selected for rescue systems shall have a strength capable of sustaining static loads applied in the directions permitted by the system of at least:
 1. 3,000 lbs. (13.3 kN) for non-certified anchorages, or
 2. Five times the foreseeable force for certified anchorages. When more than one rescue system is attached to an anchorage, the strengths set forth in (1) and (2) above shall be multiplied by the number of systems attached to the anchorage.
- E. CLIMBING:** The structure to which a climbing system is attached must sustain the loads required by that particular system. See instructions for climbing system for requirements.

3.0 DONNING AND USE

WARNING: Do not alter or intentionally misuse this equipment. Consult DBI-SALA when using this equipment in combination with components or subsystems other than those described in this manual. Some subsystem and component combinations may interfere with the operation of this equipment. Use caution when using this equipment around moving machinery, electrical and chemical hazards, and sharp edges.

WARNING: Consult your doctor if there is reason to doubt your fitness to safely absorb the shock from a fall arrest. Age and fitness seriously affect a worker's ability to withstand falls. Pregnant women or minors must not use any DBI-SALA full body harness.

3.1 BEFORE EACH USE of this equipment inspect it according to section 5.0 of this manual.

3.2 PLAN your system before use. Consider all factors that will affect your safety during use of this equipment. The following list gives important points to consider when planning your system:

- **ANCHORAGE:** Select an anchorage that meets the requirements specified in sections 1.2 and 2.5.
- **SHARP EDGES:** Avoid working where system components may be in contact with, or abrade against, unprotected sharp edges.
- **AFTER A FALL:** Components which have been subjected to the forces of arresting a fall must be removed from service and destroyed.
- **RESCUE:** The employer must have a rescue plan when using this equipment. The employer must have the ability to perform a rescue quickly and safely.

3.3 DONNING AND FITTING THE HARNESS:

Delta Vest™ Harness:

See Figure 11 for front and back views of the Delta Vest™ harness. Don the Delta Vest™ full body harness by following these steps (see Figures 12 and 13).

- Step 1.** Lift harness by the back D-ring and untangle straps. Allow leg straps to hang free.
- Step 2.** Don the Vest Harness as you would a jacket. Do not zip the vest at this time.
- Step 3.** Connect chest strap by passing male buckle through female buckle. Pass excess webbing through loop keepers.
- Step 4.** Reach between legs and grasp the leg strap on your left side. Bring the strap up between your legs and connect to buckle attached to yellow strap (orange on high visibility models, black on flame resistant models) as shown in Figures 12 and 13. Connect right leg strap.
- Step 5.** Reach inside the vest and adjust shoulder straps to a snug fit. Left and right shoulder straps should be adjusted to the same length. Readjust leg straps, chest strap, and shoulder straps as necessary to a snug fit.
- Step 6.** Zip the vest.

Figure 12 - Donning the Delta Vest™ Harness

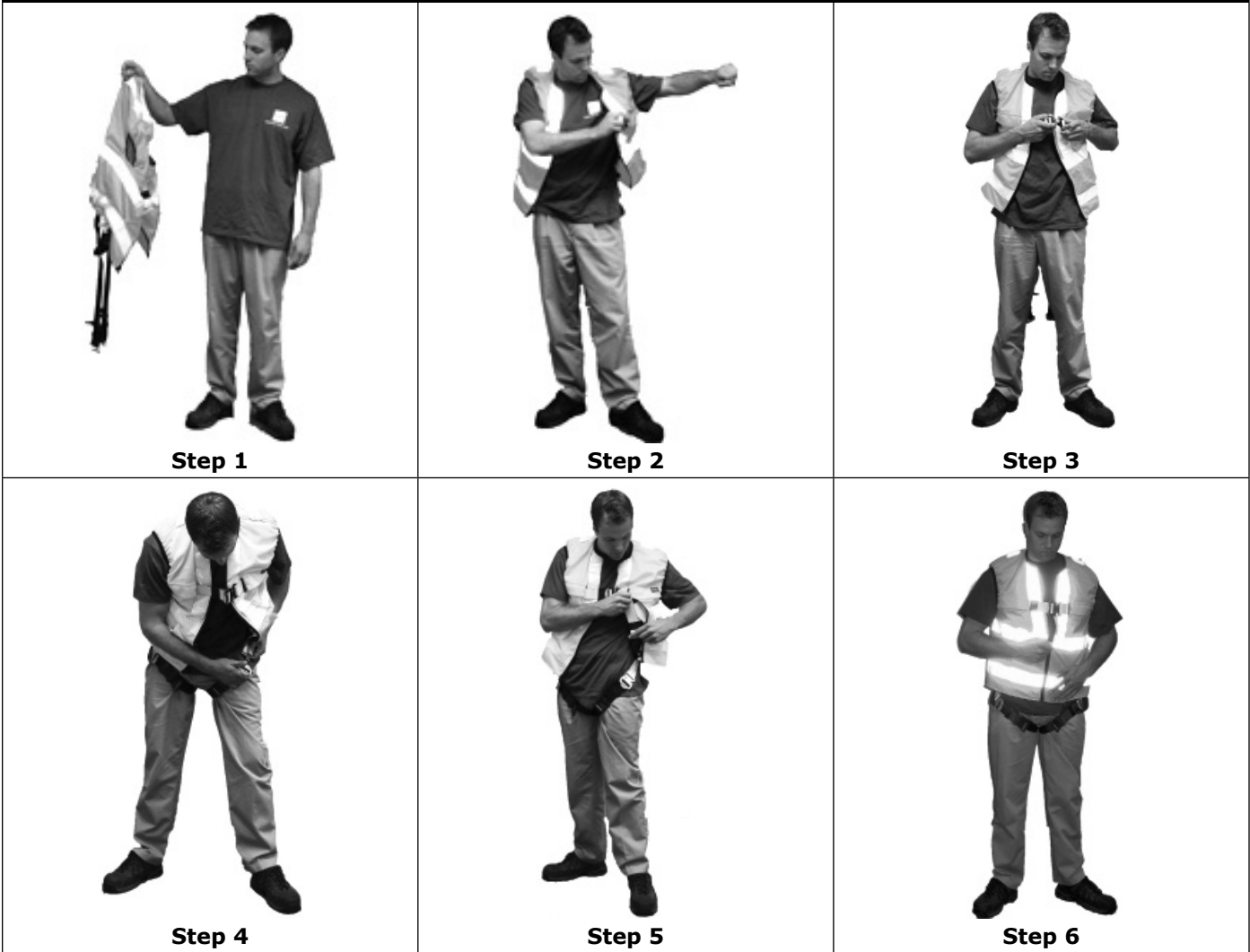

Step 1

Step 2

Step 3

Step 4

Step 5

Step 6

Figure 13A - Delta Vest™ Harness Buckle Connections

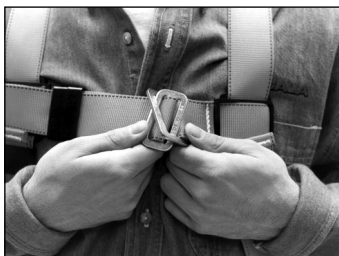

Chest Strap: Pass male buckle through female buckle and pull free end of webbing to tighten.



Tongue Buckle: Pass webbing through buckle and insert tongue through grommet.



Pass Buckle: Pass male buckle through female buckle and pull free end of webbing to tighten.



Quick Connect Buckle: Insert the tab of the buckle into the receptor of the quick connect buckle until a click is heard.

Figure 13B - Revolver™ Vertical Torso Adjuster

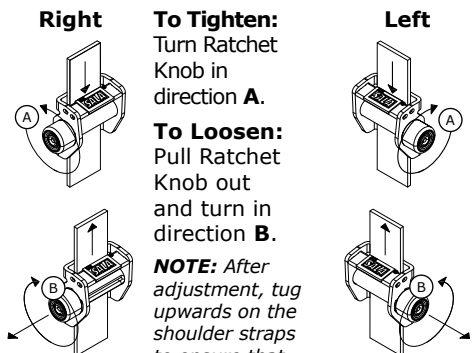

Vest Style Harness:

If your harness incorporates loops for a removable waist belt, the belt should be installed through the four loops in the harness as shown in Figure 14. The hip pad, if used, is secured to the belt by passing the belt through the hip pad loops. Don the vest style full body harness by following these steps (see Figures 14-16B):

NOTE: Vest Style harnesses contain different harness buckle connections. See Figure 16A for the style that applies to your harness.

- Step 1.** Locate back D-ring held in position by the D-ring pad; lift up harness and hold by this D-ring. Ensure the straps are not twisted.
- Step 2.** Grasp the shoulder straps and slip harness onto one arm. D-ring will be located on your back side. Ensure straps are not tangled and hang freely. Slip free arm into harness and position shoulder straps on top of shoulder. Chest strap buckle will be positioned on front side when worn properly. Pass excess strap through the loop keepers.
- Step 3.** Reach between your legs and grasp the leg strap on your left side. Bring the strap up between your legs and connect it as shown in Figure 16A. Pull the free end of the strap away from the buckle to make a snug fit on each leg strap. To loosen the leg strap, grasp the buckle and pull away from your leg to allow the strap to pull through the buckle. A plastic end keeper on the end of the strap will stop it from pulling completely out of the buckle. To release the buckle. Repeat this procedure for the right side.
- Step 4.** Adjust the waist belt by inserting the buckle tongue into the grommet on the left side as shown in Figure 16A.
- Step 5.** Attach the chest strap by connecting the buckle. See Figure 16A. Chest strap should be six inches down from the top of shoulders. Pass excess strap through the loop keepers. The strap may be tightened to a snug fit by pulling the free strap end to the left (away from the buckle). To loosen the chest strap, grasp the buckle and pull away from the body to allow the strap to pull through the buckle. A plastic end keeper on the end of the strap will stop it from pulling completely out of the buckle.
- Step 7.** Adjust shoulder straps to a snug fit (Figure 16B). Left and right sides of shoulder straps should be adjusted to the same length and the chest strap should be centered on your lower chest, six inches down from shoulder. The front D-ring on vest style harness is moved up or down by adjusting the shoulder straps and leg straps. Center the back D-ring between shoulder blades. Adjust leg straps to a snug fit. At least three inches of webbing must extend past buckle on leg straps. Adjust the waist belt (if present). Center retrieval D-rings (if present) on top of each shoulder.

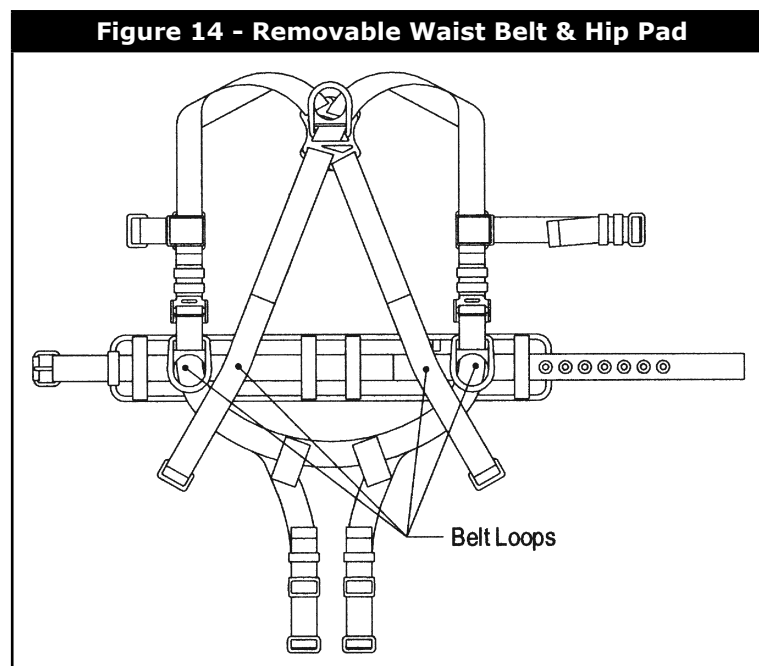
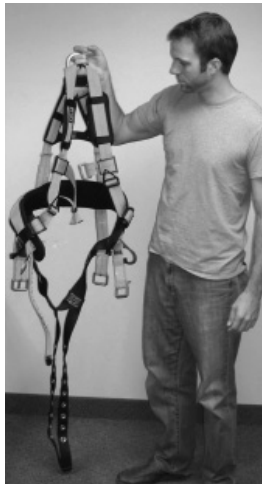

Figure 15 - Donning Vest Style Harness



Step 1



Step 2



Step 3



Step 4

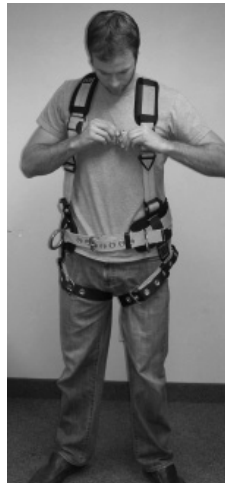

Step 5

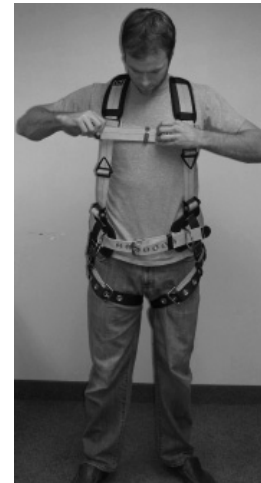

Step 6

Figure 16A - Vest Style Harness Buckle Connections



Chest Strap: Pass male buckle through female buckle and pull free end of webbing to tighten.



Chest Strap: Attach chest strap by inserting the tab of the buckle into the receptor of the quick connect buckle until a click is heard.



Tongue Buckle: Pass webbing through buckle and insert tongue through grommet.



Pass Buckle: Pass male buckle through female buckle and pull free end of webbing to tighten.



Quick Connect Buckle: Insert the tab of the buckle into the receptor of the quick connect buckle until a click is heard.

16B - Revolver™ Vertical Torso Adjusters

Right

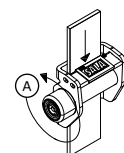

To Tighten: Turn Ratchet Knob in direction **A**.

To Loosen: Pull Ratchet Knob out and turn in direction **B**.

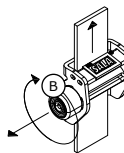

NOTE: After adjustment, tug upwards on the shoulder straps to ensure that each adjuster is locked in place.

Left

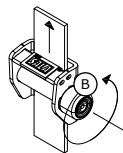
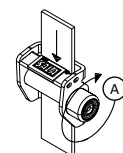

CROSS-OVER STYLE HARNESS:

If your harness incorporates loops for a removable waist belt, the belt should be installed through the four loops in the harness as shown in Figure 17. The hip pad, if used, is secured to the belt by passing the belt through the hip pad loops. Don the cross-over style full body harness by following these steps (see Figures 17-19B):

NOTE: Cross-Over Style harnesses contain different harness buckle connections. See Figure 19A for the style that applies to your harness.

- Step 1.** Locate back D-ring held in position by the D-ring pad; lift up harness and hold by this D-ring. Ensure the straps are not twisted.
- Step 2.** Grasp shoulder straps between back and front D-ring and slip harness over your head from the left side. Position shoulder straps on top of shoulder. Ensure straps are not tangled and hang freely. The D-ring will be positioned on your back when worn properly.
- Step 3.** Grasp the buckle below the front D-ring and connect (Figure 19A). Ensure straps are not tangled or crossed.
- Step 4.** Reach between legs and grasp blue leg strap on your left side. Bring strap up between legs and connect to buckle. Connect right leg strap (Figure 19A).
- Step 5.** Adjust shoulder straps to a snug fit (Figure 19B). Left and right sides of shoulder straps should be adjusted to the same length and the front D-ring should be centered on your lower chest. The back D-ring should be centered between your shoulder blades. Adjust leg straps to a snug fit. Adjust the waist belt (if present). Center retrieval D-rings (if present) on top of each shoulder.

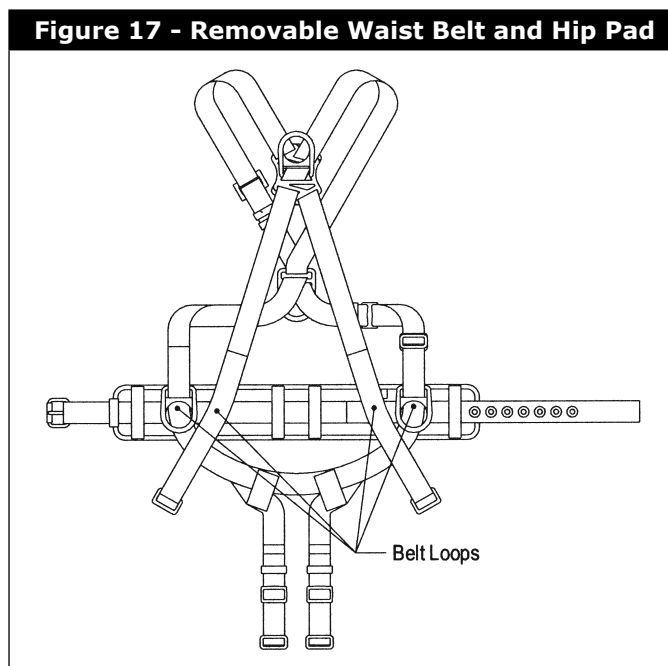

- 3.4 USE OF FALL ARREST D-RING OR ATTACHMENT ELEMENT:** For fall protection applications connect to the D-ring or attachment element on your back, between your shoulder blades. Side D-rings, if present, are for positioning or restraint applications only. Shoulder retrieval D-rings are for rescue or retrieval applications only. Front D-ring is for ladder climbing or positioning. D-rings on seat sling are for suspension or positioning applications only.
- 3.5 MAKING CONNECTIONS:** When using a hook to connect to an anchorage or when coupling components of the system together, ensure roll-out cannot occur. Roll-out occurs when interference between the hook and mating connector causes the hook gate to unintentionally open and release. Self-locking snap hooks and carabiners should be used to reduce the possibility of roll-out. Do not use hooks or connectors that will not completely close over the attachment object. See subsystem manufacturer's instructions for more information on making connections.
- 3.6 CONNECTING SYSTEM COMPONENTS:** After fitting the full body harness the user may then connect to other system components. Follow the guidelines in section 3.4 on selecting the correct attachment element.

Figure 18 - Donning Cross-over Style Harness



Step 1

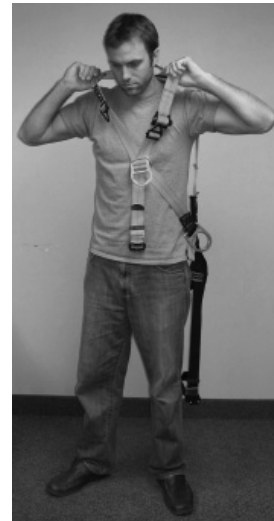

Step 2



Step 3



Step 4



Step 5

Figure 19A - Cross-over Style Harness Buckle Connections



Tongue Buckle: Pass webbing through buckle and insert tongue through grommet.



Quick Connect Buckle: Insert the tab of the buckle into the receptor of the quick connect buckle until a click is heard.



Pass Buckle: Pass male buckle through female buckle and pull free end of webbing to tighten.

Figure 19B - Revolver Torso Adjuster

To Tighten: Turn Ratchet Knob in direction **A**.

To Loosen: Pull Ratchet Knob out and turn in direction **B**.

NOTE: After adjustment, tug upwards on the shoulder straps to ensure that each adjuster is locked in place.

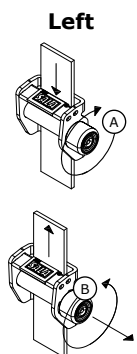

4.0 TRAINING

- 4.1** It is the responsibility of the user and the purchaser of this equipment to assure that they are familiar with these instructions, trained in the correct care and use of, and are aware of the operating characteristics, application limits, and the consequences of improper use of this equipment.

IMPORTANT: Training must be conducted without exposing the user to a fall hazard. Training should be repeated on a periodic basis.

5.0 INSPECTION

- 5.1** The i-Safe™ RFID tag on this harness can be used in conjunction with the i-Safe handheld reading device and the web based portal to simplify inspection and inventory control and provide records for your fall protection equipment See Figure 22.
- 5.2 FREQUENCY:** Before each use inspect the full body harness according to sections 5.3 and 5.4. The harness must also be inspected by a competent person, other than the user, at least annually. Record the results of each Competent Person inspection in the inspection and maintenance log in section 9.0, or use the i-Safe™ inspection web portal to maintain your inspection records. If you are a first-time user, contact a Customer Service representative (See Back Cover) or if you have already registered, access isafe.capitalsafety.com. Follow instructions provided with your i-Safe handheld reader or on the web portal to transfer your data to your web log.

IMPORTANT: If the full body harness has been subjected to fall arrest or impact forces it must be immediately removed from service and destroyed.

IMPORTANT: Extreme working conditions (harsh environments, prolonged use, etc.) may require increasing the frequency of inspections.

5.3 INSPECTION STEPS:

- Step 1.** Inspect harness hardware (buckles, D-rings, back pad, loop keepers); These items must not be damaged, broken, distorted, and must be free of sharp edges, burrs, cracks, worn parts, or corrosion. PVC coated hardware must be free of cuts, rips, tears, holes, etc. in the coating to ensure non-conductivity. Ensure buckles work smoothly. If present, inspect the quick connect buckles by ensuring that the release tabs work freely and that a click is heard when the buckle engages. Inspect parachute buckle spring.
- Step 2.** Inspect webbing; material must be free of frayed, cut, or broken fibers. Check for tears, abrasions, mold, burns, or discoloration. Inspect stitching; Check for pulled or cut stitches. Broken stitches may be an indication that the harness has been impact loaded and must be removed from service.
- IMPORTANT:** On Delta Vest™ harnesses, inspection should include the webbing inside the vest.
- Step 3.** Inspect labels; All labels should be present and fully legible. See section 8.0.
- Step 4.** Inspect each system component or subsystem according to manufacturer's instructions.
- Step 5.** Inspect the Stitched Impact Indicator (Figure 21): The Stitched Impact Indicator (A) is a section of webbing that is lapped back on itself and secured with a specific stitch pattern holding the lap. The stitch pattern is designed to release when the harness arrests a fall or has been subjected to an equivalent force. If the impact indicator has been activated the harness must be removed from service and destroyed.

NOTE: Some harnesses are equipped with a "stand up D-ring" in the dorsal (back) D-ring location. If the spring in the D-ring is damaged or lost and the D-ring no longer stands up, this does not compromise the harness integrity. As long as the D-ring passes inspection criteria in Step 1, it is safe to use.

Figure 20 - i-Safe™ RFID Tag

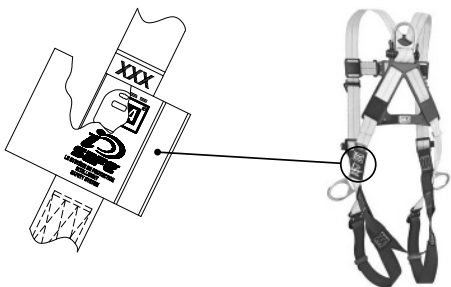
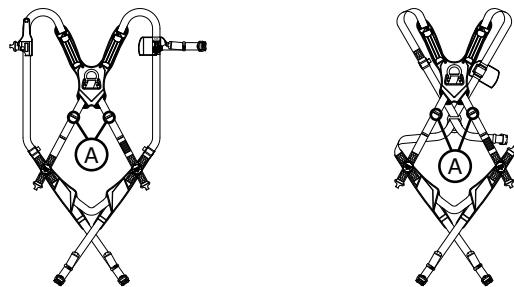

Figure 21 - Stitched Impact Indicator



5.4 DEFECTS: If inspection reveals a defective condition, remove unit from service immediately and destroy.

NOTE: Only DBI-SALA or parties authorized in writing may make repairs to this equipment.

5.5 PRODUCT LIFE: The functional life of DBI-SALA harnesses is determined by work conditions and maintenance. As long as the product passes inspection criteria, it may remain in service.

6.0 MAINTENANCE, SERVICING, STORAGE

6.1 WASHING INSTRUCTIONS:

Full body harness: Clean full body harness with water and a mild soap solution. Do not use bleach or bleach solutions. Wipe off hardware with a clean, dry cloth, and hang to air dry. Do not force dry with heat. An excessive buildup of dirt, paint, etc. may prevent the full body harness from working properly, and in severe cases degrade the webbing to a point where it weakens and should be removed from service. More information on cleaning is available from DBI-SALA. If you have questions concerning the condition of your harness, or have any doubt about putting it into service contact DBI-SALA.

Fire Resistant Padding:

- Remove pads from harness for laundering. Place the harness in the supplied laundry bag. The bag is designed to prevent entanglement of harness and to protect the washing machine from damage. Use of the laundry bag to wash the pads is optional.
- Launder flame resistant pads separately from harness or other non-flame resistant garments. Lint from other garments may affect flame resistance.
- Use a bleach-free detergent when washing both the harness and the pads. Do not use soap; soap may leave a residue which could affect flame resistance.
- Do not use chlorine bleach. Bleach may weaken fabric and reduce product life.
- Oily or greasy stains may be pre-treated and washed in hot water 140°F max (60°C max).
- Use delicate, permanent press, or cotton sturdy wash cycle with cold or warm water. Hot water can be used on heavily soiled items as long as it does not exceed 140°F (60°C). Use extra rinse cycle to be sure all residual wash chemicals are removed.
- Air dry or tumble dry using permanent press cycle and low heat. Drying temp should not exceed 200°F (93°C). These fabrics dry quickly, for lowest shrinkage, do not over dry.

6.2 Additional maintenance and servicing procedures must be completed by a factory authorized service center. Authorization must be in writing. Do not attempt to disassemble the unit.

6.3 Store full body harnesses in a cool, dry, clean environment out of direct sunlight. Avoid areas where chemical vapors may exist. Thoroughly inspect the full body harness after extended storage.

7.0 SPECIFICATIONS

7.1 PERFORMANCE

Maximum Free Fall Distance: No greater than 6 feet (1.8 m), per federal law and ANSI Z359.1.

Maximum Arresting Force: 1,800 lbs. (8 kN)

Capacity: ANSI Z359.1--310 lbs (141 kg), CSA Z259.10-06--352 lbs (160 kg)

Approximate Weight:

- Harness only: 3 lbs. (1.4 kg)
- Harness with Side D-rings: Add 1/2 lb. (.23 kg)
- Harness with Back Pad or Belt: Add 1 lb. (.45 kg)

Cross-over Style Harness Patent numbers: United States: 5,203,829, Canada: 2,080,643

All harnesses, excluding Kevlar harnesses, meet ANSI Z359.1 and OSHA requirements.

7.1 MATERIALS

Standards: All harnesses marked with ASTM F887-2004 meet all testing requirements of the standard.

Webbing Materials: 6,000 lbs (27kN) Tensile Strength Polyester; 7,000 lbs (31 kN) Tensile Strength Nylon; 7,000 lbs. (31 kN) Tensile Strength Nomex™ covered Kevlar™.

Pad and Label Cover Materials:







- All outer fabric is Nomex and Kevlar blend fabric
- Fire resistant hook and loop fasteners

Optional Accessories:

- Hip Pad with side D-ring
- Nomex covered Kevlar webbing
- Non-sparking/ Non-conductive PVC coated hardware
- Arc-rated hip, leg, and back pads
- Polyurethane coated, arc-rated dorsal web loop

8.0 LABELING

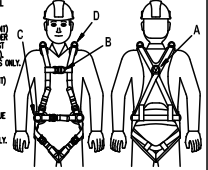
8.1 The following labels must be present and completely legible:

ANSI	CSA																																								
 <p>RFID Tag</p>	 <p>RFID Tag</p>																																								
 <p>Size Label</p>	 <p>Size Label</p>																																								
<div data-bbox="186 682 587 856"> <p>WARNING MANUFACTURER'S INSTRUCTIONS MUST BE READ AND UNDERSTOOD PRIOR TO USE. INSTRUCTIONS SUPPLIED WITH THIS PRODUCT AT TIME OF SHIPMENT MUST BE FOLLOWED. FAILURE TO DO SO COULD RESULT IN SERIOUS INJURY OR DEATH. CONTACT DBI-SALA IF INSTRUCTION SHEET IS NEEDED. INSPECT BEFORE EACH USE. DO NOT USE IF WEAR OR DAMAGE IS PRESENT. THIS BODY HARNESS IS INTENDED TO BE USED TO ARREST THE MOST SEVERE FREE FALLS. ITEMS SUBJECTED TO FALL ARREST OR IMPACT FORCES MUST BE IMMEDIATELY REMOVED FROM SERVICE AND DESTROYED. CONNECTING SNAP AND D-RING MUST BE COMPATIBLE IN SIZE, SHAPE, AND STRENGTH. THIS ITEM IS NOT FLAME OR HEAT RESISTANT. REPAIRS ONLY TO BE PERFORMED BY DBI-SALA. EQUIPMENT MODIFICATION OR MISUSE VOIDS WARRANTY.</p> </div> <div data-bbox="186 865 587 1039"> <p>DBI-SALA BODY HARNESS POLYESTER WEB CAPACITY: 420 LBS. WARNING DO NOT EXCEED CAPACITY OF THIS OR OTHER SYSTEM COMPONENTS. CAPACITY IS THE COMBINED WEIGHT FOR WHICH THE COMPONENT IS DESIGNED TO BE USED. COMBINED WEIGHT INCLUDES THE USER'S BODY WEIGHT, CLOTHING, TOOLS, AND ANY OBJECTS CARRIED. CONTACT DBI-SALA FOR MORE INFORMATION.</p> <p>DO NOT REMOVE LABEL. MADE IN XXXX</p> </div>	<div data-bbox="657 682 1058 871"> <p>Full Body Harness Harnois de sécurité Polyester web Sangle polyester Size: See Label Grandeur: Voir étiquette Do not remove label Ne pas enlever cette étiquette Made in Canada Fabriqué au Canada CSA STANDARD Z259.10-06</p> </div> <div data-bbox="657 882 1058 1081"> <p>WARNING/AVERTISSEMENT! Any unit which has seen a fall arresting service should not be used after such service. Before use, read and comply with all labels and separate instructions. Failure to do so could result in serious injury or death. Contact Capital Safety if written instruction sheet is needed. Inspect before each use. If wear damage exists, do not use. This body harness is intended to be used to arrest the most severe falls. Connecting snap and D-ring must be compatible in size, shape and strength. This item is not flame or heat resistant. Repairs only to be performed by Capital Safety Group. Equipment modification or misuse voids warranty. On ne doit pas utiliser un dispositif après qu'il a servi à arrêter une chute. Avant de l'utiliser, on doit lire et observer les instructions sur toutes les étiquettes et dans les autres documents. Négliger de le faire peut causer des blessures graves, voire mortelles. Consultez avec Capital Safety si on a besoin d'une fiche d'instructions. Inspecter avant chaque utilisation. Si il y a des dommages dus à de l'usage, ne pas utiliser. Ce harnois de sécurité est destiné à être utilisé pour arrêter les plus chutes. Le matériel et l'usage en il de fixation doivent être compatibles en taille, forme et résistance. Ce dispositif ne réalise pas aux flammes ou à la chaleur. Les réparations doivent être effectuées seulement par le Capital Safety Group. Une modification ou un usage abusif de l'équipement annule la garantie.</p> </div>	<div data-bbox="1096 682 1513 871"> <p>DBI-SALA BODY HARNESS/Harnois de sécurité POLYESTER WEB/Sangle polyester DO NOT REMOVE THIS LABEL/ Ne pas enlever cette étiquette HARNES CLASSIFICATION/ Classe de Harnois www.capitalsafety.com Capital Safety Red Wing, MN USA +1-800-328-6146 CSA STANDARD Z259.10-06</p> </div> <div data-bbox="1096 882 1513 1081"> <p>WARNING MANUFACTURER'S INSTRUCTIONS MUST BE READ AND UNDERSTOOD PRIOR TO USE. INSTRUCTIONS SUPPLIED WITH THIS PRODUCT AT TIME OF SHIPMENT MUST BE FOLLOWED. FAILURE TO DO SO COULD RESULT IN SERIOUS INJURY OR DEATH. CONTACT CAPITAL SAFETY IF INSTRUCTION SHEET IS NEEDED. INSPECT BEFORE EACH USE. REMOVE FROM SERVICE AFTER FALL ARREST. REMOVE FROM SERVICE IF WEAR DAMAGE IS PRESENT DURING INSPECTION. MAKE ONLY COMPATIBLE CONNECTIONS. DO NOT ALTER OR REPAIR HARNESS. AVERTISSEMENTS LES INSTRUCTIONS DU FABRICANT DOIVENT ETRE LUES ET COMPRIS PREALABLEMENT A L'UTILISATION. LES INSTRUCTIONS FOURNIES AVEC CE PRODUIT AU MOMENT DE L'EXPEDITION DOIVENT ETRE SUIVIES. NEGLIGER CES RECOMMANDATIONS PEUT ENTRAINER DES BLESSURES GRAVES, VOIRE MORTELLES. CONTACTER CAPITAL SAFETY EN CAS DE BESOIN DE NOTICE. INSPECTER AVANT CHAQUE UTILISATION. METTRE HORS SERVICE APRES L'ARRET D'UNE CHUTE. METTRE HORS SERVICE SI L'INSPECTION REVELE DES DOMMAGES DUS A L'USURE. EFFECTUER SEULEMENT DES FIXATIONS COMPATIBLES. NE PAS MODIFIER OU REPARER LE HARNESS.</p> </div>																																							
<div data-bbox="214 1144 555 1312"> <p>A - BACK D-RING IS FOR FALL ARREST AND RESCUE. B - FRONT D-RING (IF PRESENT) IS FOR POSITIONING, LADDER CLIMBING, OR FALL ARREST (IF NEARER FREESTYLE). C - SIDE D-RINGS (IF PRESENT) ARE FOR POSITIONING. D - SHOULDER D-RINGS (IF PRESENT) ARE FOR RESCUE ONLY. DO NOT USE FOR OTHER PURPOSES. SEE INSTRUCTIONS FOR MORE DETAILS.</p>  </div> <div data-bbox="214 1323 555 1522"> <p>USER IDENTIFICATION MARK LABEL WITH PERMANENT MARKER</p> </div>	<div data-bbox="876 1144 1286 1312"> <p>1 2 3 4 5 * FULL ARREST CLASS A AND RESCUE/NETS NOT COVERED BY STANDARD CLASS A (AND Z259.1 AND Z259.4) * LADDER ACCESS/ACCESS LADRE/PANTELIER CLASS B (CLASS L (AND Z259.4)) * FOR POSING METALS/Pour LES SYSTEMES METALLIQUES (AND Z259.1 - NOT BE USED FOR FALL ARREST/NE PAS UTILISER PREALABLEMENT POUR L'ARRET DES CHUTES DE CHUTE) * FOR POSING METALS/Pour LES SYSTEMES METALLIQUES (AND Z259.1 - NOT BE USED FOR FALL ARREST/NE PAS UTILISER PREALABLEMENT POUR L'ARRET DES CHUTES DE CHUTE) SEE INSTRUCTIONS FOR MORE DETAILS/VOIR LES INSTRUCTIONS POUR PLUS DE DETAILS</p>  </div> <div data-bbox="876 1323 1286 1522"> <p>USER IDENTIFICATION / IDENTIFICATION DE L'UTILISATEUR MARK LABEL WITH PERMANENT MARKER / MARQUER L'ÉTIQUETTE AVEC UN MARQUEUR PERMANENT</p> </div>																																								
<div data-bbox="186 1564 587 1732"> <p>PRODUCT COMPLIANCE THIS PRODUCT COMPLIES WITH THE FOLLOWING STANDARDS ONLY IF MARKED WITH THE CORRESPONDING LETTER CODE UNDER "STD'S" SECTION BELOW. A = ANSI Z359.1 B = OSHA C = ANSI A10.32-2004 D = ASTM F887-2005 E = ANSI Z359.3 F = ANSI Z359.4 MFRD(YR/MO); LOT; MODEL NO.; STD'S:</p> </div> <div data-bbox="186 1743 587 1942"> <p>SERIAL NO.: SEE RFID TAG IN CLEAR POUCH</p> <table border="1"> <tr> <td>INITIAL</td> <td></td> <td></td> <td></td> <td></td> <td></td> <td></td> <td></td> <td></td> <td></td> </tr> <tr> <td>DATE</td> <td></td> <td></td> <td></td> <td></td> <td></td> <td></td> <td></td> <td></td> <td></td> </tr> </table> <p>INSPECTION LOG DO NOT REMOVE THIS LABEL</p> </div>	INITIAL										DATE										<div data-bbox="876 1648 1286 1816"> <p>INSPECTION LOG RELIEVE D'INSPECTION SERIAL NO./NUMERO DE SERIE: SEE RFID TAG IN CLEAR POUCH / VOIR L'ÉTIQUETTE DE RFID DANS LA POCHE TRANSPARENTE MFRD/LOT/FABR. LOT: (YR/MO)(AA/MM) MODEL NO./MODÈLE</p> <table border="1"> <tr> <td>INITIAL</td> <td></td> <td></td> <td></td> <td></td> <td></td> <td></td> <td></td> <td></td> <td></td> </tr> <tr> <td>DATE</td> <td></td> <td></td> <td></td> <td></td> <td></td> <td></td> <td></td> <td></td> <td></td> </tr> </table> <p>DO NOT REMOVE THIS LABEL / NE PAS ENLEVER CETTE ÉTIQUETTE</p> </div>	INITIAL										DATE									
INITIAL																																									
DATE																																									
INITIAL																																									
DATE																																									

This instruction applies to the following models:

AA7059A	1101253	1101631	1101806	1102000	1102541	1103270ALT1	1103884
AA7060A	1101253H	1101632	1101807	1102000H	1102542	1103270	1103885
1100092	1101254	1101633	1101808	1102001	1102543	1103321	1103886
1100181	1101254H	1101634	1101809	1102002	1102543H	1103350	1103888
1100195	1101255	1101635	1101810	1102003	1102546	1103351	1104125
1100230	1101255H	1101636	1101812	1102004	1102548	1103352	1104126
1100231	1101256	1101637	1101813	1102005	1102549	1103353	1104625
1100232	1101257	1101638	1101814	1102008	1102556	1103354	1104626
1100233	1101258	1101639	1101815	1102009	1102557	1103355	1104627
1100245	1101259	1101640	1101816	1102010	1102558	1103356	1104628
1100246	1101260	1101641	1101817	1102010ALT1	1102559	1103357	1104629
1100247	1101261	1101642	1101818	1102010	1102560	1103358	1104630
1100299	1101262	1101643	1101819	1102025	1102561	1103359	1104632
1100406	1101266	1101644	1101820	1102026	1102562	1103360	1104633
1100482	1101267	1101645	1101821	1102027	1102563	1103361	1104635
1100520	1101268	1101646	1101822	1102028	1102564	1103375	1104636
1100521	1101269	1101647	1101823	1102029	1102565	1103376	1104650
1100522	1101270	1101649	1101824	1102030	1102566	1103377	1104725
1100540	1101271	1101650	1101826	1102031	1102875	1103378	1104729
1100541	1101272	1101651	1101827	1102032	1102875C	1103379	1104730
1100542	1101273	1101653	1101828	1102033	1102876	1103383	1104731
1100543	1101274	1101654	1101829	1102034	1102877	1103384	1104732
1100550	1101340	1101654H	1101830	1102035	1102878	1103385	1104733
1100675	1101341	1101655	1101831	1102036	1102879	1103386	1104734
1100676	1101420	1101655H	1101832	1102037	1102880	1103393	1104735
1100700	1101421	1101656	1101833	1102038	1102901	1103394	1104736
1100701	1101422	1101656H	1101834	1102039	1102903	1103395	1104739
1100702	1101423	1101657	1101835	1102040	1102904	1103510	1104740
1100703	1101424	1101658	1101836	1102041	1102905	1103511	1104741
1100726	1101436	1101659	1101837	1102042	1102907	1103512	1104742
1100727	1101437	1101660	1101838	1102043	1102908	1103513	1104743
1100750	1101438	1101661	1101839	1102082	1102911	1103611	1104744
1100756	1101439	1101662	1101840	1102083	1102912	1103612	1104745
1100762	1101440	1101663	1101841	1102084	1102925	1103800	1104746
1100767	1101441	1101664	1101842	1102086	1102926	1103801	1104747
1100768	1101450	1101665	1101843	1102090	1102927	1103802	1104748
1100769	1101451	1101666	1101844	1102132	1102928	1103803	1104749
1100775	1101452	1101667	1101845	1102133	1102929	1103803ALT	1104775
1100776	1101453	1101668	1101851	1102134	1102930	1103803	1104776
1100777	1101455	1101669	1101854	1102135	1102950	1103804	1104777
1100778	1101456	1101670	1101855	1102200	1102951	1103805	1104778
1100779	1101457	1101671	1101856	1102201	1102952	1103806	1104779
1100780	1101458	1101672	1101857	1102205	1102953	1103807	1104780
1100781	1101459	1101673	1101858	1102206	1102954	1103808	1104781
1100840	1101460	1101776	1101859	1102207	1102955	1103809	1104782
1100841	1101461	1101777	1101860	1102257	1102956	1103810	1104783
1100842	1101462	1101778	1101861	1102270	1102957	1103811	1104800
1100925	1101463	1101779	1101862	1102271	1102962	1103812	1104801
1100926	1101464	1101780	1101863	1102286	1102963	1103813	1104803
1100927	1101465	1101781	1101864	1102350	1102964	1103814	1104804
1100928	1101466	1101782	1101866	1102351	1102965	1103825	1104805
1100929	1101467	1101783	1101867	1102352	1102966	1103826	1104806
1101021	1101468	1101784	1101869	1102353	1102972	1103827	1104850
1101022	1101469	1101785	1101870	1102354	1102973	1103828	1104851
1101116	1101470	1101786	1101871	1102355	1103251	1103829	1104852
1101117	1101471	1101787	1101872	1102525	1103252	1103831	1104853
1101118	1101472	1101789	1101873	1102526	1103253	1103836	1104854
1101119	1101473	1101790	1101874	1102526H	1103254	1103837	1104855
1101120	1101474	1101791	1101890	1102527	1103255	1103852	1104856
1101121	1101511	1101792	1101891	1102528	1103256	1103853	1104857
1101214	1101512	1101793	1101892	1102529	1103257	1103854	1104858
1101215	1101513	1101794	1101893	1102529H	1103258	1103855	1104859
1101216	1101514	1101795	1101909	1102530	1103261C	1103856	1104860
1101217	1101515	1101796	1101910	1102531	1103262	1103860	1104861
1101218	1101516	1101797	1101911	1102532	1103262C	1103861	1104863
1101219	1101611	1101798	1101912	1102533	1103263	1103875	1104866
1101240	1101625	1101800	1101913	1102534	1103263C	1103876	1104871
1101241	1101626	1101801	1101977	1102536	1103264	1103877	1104872
1101250	1101627	1101802	1101978	1102537	1103265	1103878	1104873
1101251	1101628	1101803	1101979	1102538	1103266	1103879	1104874
1101252	1101629	1101804	1101980	1102539	1103267	1103880	1104875
1101252H	1101630	1101805	1101981	1102540	1103270	1103882	1104876

1104877	1105475	1105926	1106108	1106385	1106953	1107450	1107806H
1104878	1105476	1105950	1106109	1106386	1106954	1107450C	1107807
1104879	1105477	1105951	1106110	1106400	1106975	1107451	1107807H
1104880	1105478	1105952	1106111	1106401	1106976	1107451C	1107808
1104881	1105479	1105953	1106114	1106403	1106977	1107452	1107809
1104882	1105480	1105954	1106115	1106404	1106978	1107452C	1107810
1104885	1105481	1105975	1106116	1106405	1107000	1107453	1107811
1104886	1105482	1106000	1106117	1106406	1107001	1107453C	1107812
1104890	1105483	1106001	1106118	1106407	1107002	1107454	1107813
1104891	1105484	1106002	1106119	1106408	1107003	1107454C	1107814
1104892	1105487	1106003	1106120	1106409	1107025	1107455	1107815
1104893	1105488	1106004	1106125	1106410	1107026	1107455C	1107816
1104894	1105489	1106005	1106126	1106411	1107027	1107460	1107817
1104900	1105490	1106006	1106127	1106414	1107075	1107461	1107817H
1104901	1105491	1106007	1106150	1106425	1107125	1107462	1107818
1104902	1105500	1106008	1106151	1106426	1107126	1107463	1107819
1104903	1105555	1106009	1106152	1106427	1107127	1107465	1107820
1104904	1105556	1106010	1106175	1106450	1107128	1107466	1107821
1104905	1105577	1106011	1106180	1106450H	1107129	1107467	1107822
1104906	1105650	1106012	1106200	1106451	1107150	1107468	1107823
1104907	1105651	1106013	1106201	1106451H	1107151	1107469	1107824
1104908	1105652	1106017	1106203	1106452	1107152	1107470	1107825
1104909	1105675	1106018	1106204	1106452H	1107153	1107471	1107828
1104910	1105676	1106019	1106205	1106453	1107154	1107475	1107829
1104911	1105677	1106020	1106207	1106453H	1107200	1107475C	1107830
1104912	1105678	1106021	1106208	1106454	1107201	1107476	1107831
1104914	1105679	1106022	1106209	1106455	1107202	1107476C	1107832
1104915	1105680	1106023	1106210	1106456	1107203	1107477	1107833
1104916	1105681	1106024	1106211	1106476	1107204	1107477C	1107834
1104917	1105682	1106025	1106275	1106477	1107205	1107478	1107836
1104918	1105683	1106028	1106279	1106478	1107206	1107478C	1107850
1104919	1105725	1106028H	1106300	1106479	1107207	1107479	1107851
1104920	1105726	1106029	1106301	1106480	1107225	1107479C	1107855
1104921	1105727	1106030	1106302	1106481	1107250	1107480	1107875
1104924	1105728	1106031	1106303	1106482	1107251	1107480C	1107926
1104950	1105729	1106032	1106304	1106550	1107252	1107500	1107950
1104952	1105732	1106033	1106305	1106675	1107275	1107501	1107951
1104953	1105733	1106034	1106306	1106676	1107276	1107525	1107952
1104954	1105734	1106035	1106307	1106677	1107277	1107526	1107954
1104955	1105735	1106036	1106308	1106679	1107278	1107550	1107957
1105000	1105750	1106037	1106309	1106680	1107279	1107551	1107958
1105001	1105751	1106039	1106310	1106681	1107400	1107575	1107959
1105002	1105752	1106040	1106325	1106682	1107400C	1107576	1107960
1105003	1105753	1106041	1106326	1106683	1107402	1107577	1107962
1105004	1105754	1106048	1106327	1106684	1107402C	1107578	1108000
1105005	1105755	1106055	1106328	1106687	1107403	1107579	1108001
1105300	1105801	1106056	1106329	1106688	1107404	1107580	1108002
1105301	1105802	1106057	1106330	1106700	1107405	1107600	1108003
1105325	1105803	1106058	1106331	1106701	1107406	1107626	1108025
1105326	1105804	1106059	1106332	1106702	1107406C	1107629	1108026
1105327	1105825	1106063	1106333	1106703	1107407	1107630	1108034
1105328	1105825C	1106066	1106334	1106704	1107407C	1107650	1108100
1105329	1105826	1106067	1106350	1106725	1107408	1107651	1108101
1105330	1105827	1106068	1106351	1106726	1107408C	1107652	1108102
1105331	1105828	1106069	1106352	1106727	1107409	1107653	1108103
1105350	1105829	1106070	1106354	1106728	1107410	1107656	1108104
1105375	1105830	1106071	1106355	1106729	1107415	1107658	1108105
1105375C	1105830C	1106072	1106356	1106730	1107416	1107659	1108106
1105376	1105831	1106074	1106357	1106750	1107417	1107725	1108107
1105377	1105832	1106076	1106365	1106751	1107418	1107726	1108108
1105378	1105833	1106077	1106366	1106754	1107419	1107727	1108109
1105379C	1105834	1106078	1106367	1106755	1107420	1107775	1108125
1105382	1105835	1106079H	1106368	1106756	1107421	1107776	1108126
1105383	1105836	1106080H	1106369	1106800	1107422	1107777	1108127
1105384	1105837	1106081	1106370	1106801	1107425	1107778	1108128
1105400	1105838	1106082H	1106375	1106802	1107425C	1107781	1108129
1105401	1105840	1106083H	1106376	1106900	1107426	1107782	1108130
1105405	1105850	1106100	1106377	1106901	1107427	1107783	1108131
1105406	1105851	1106101	1106378	1106902	1107427C	1107784	1108132
1105407	1105852	1106102	1106379	1106903	1107428	1107801	1108133
1105408	1105853	1106103	1106380	1106904	1107428C	1107802	1108134
1105409	1105854	1106104	1106381	1106905	1107429	1107803	1108175
1105410	1105900	1106105	1106382	1106950	1107429C	1107804	1108176
1105411	1105901	1106106	1106383	1106951	1107430	1107805	1108177
1105450	1105925	1106107	1106384	1106952	1107430C	1107806	1108178

1108179	1109109	1109558	1110588	1110787	1111003	1111613	3103350
1108184	1109110	1109559	1110589	1110792	1111004	1150054	3103351
1108185	1109111	1109560	1110590	1110793	1111275	1150058	3103375
1108186	1109121	1109561	1110591	1110800	1111276	1160000	3103386
1108187	1109125	1109575	1110600	1110801	1111277	1160001	3103387
1108188	1109126	1109651	1110601	1110802	1111278	1160001	3103388
1108189	1109127	1109652	1110602	1110803	1111279	1160002	3103389
1108190	1109128	1109653	1110603	1110810	1111280	1160008	3103390
1108225	1109129	1109654	1110604	1110811	1111325	1170002	3103395
1108226	1109130	1109675	1110605	1110812	1111326	1170002	3103420
1108227	1109142	1109676	1110606	1110813	1111327	1170002	3103450
1108228	1109143	1109677	1110608	1110814	1111330	1170003	3103451
1108229	1109144	1109678	1110618	1110820	1111331	1170003	3103452
1108300	1109145	1109850	1110625	1110830	1111332	1170003	3103453
1108301	1109150	1109851	1110626	1110831	1111500H	1310065	3103471
1108302	1109151	1109852	1110675	1110832	1111501H	1370111	3103515
1108305	1109152	1109853	1110700	1110850	1111502H	1370112	3103520
1108307	1109400	1109854	1110701	1110851	1111503H	2104168	3103521
1108308	1109425	1109855	1110702	1110852	1111504H	2104169	3103522
1108309	1109426	1109885	1110704	1110853	1111505H	2104170	3103523
1108310	1109427	1109886	1110725	1110854	1111506H	2104171	3103524
1108311	1109429	1109975	1110727	1110855	1111507H	2104172	3103543
1108375	1109431	1109976	1110750	1110856	1111508H	2104173	3103544
1108376	1109441	1109977	1110751	1110857	1111509H	2104174	3103547
1108377	1109446	1110025	1110752	1110858	1111575	2104175	3103549
1108378	1109447	1110026	1110753	1110859	1111577	2104176	6100771
1108379	1109448	1110027	1110754	1110930	1111578	2104177	6100771
1108380	1109449	1110028	1110755	1110935	1111579	2104178	6100772
1108400	1109450	1110029	1110760	1110942	1111580	2104179	6100772
1109000	1109451	1110030	1110761	1110950	1111581	2104180	6100776
1109002	1109475	1110052	1110762	1110951	1111582	2104181	6100776
1109062	1109500	1110570	1110770	1110952	1111583	2104182	6100777
1109075	1109501	1110575	1110771	1110953	1111584	2104205	6100777
1109076	1109502	1110575H	1110772	1110954	1111585	3103300	6116604
1109077	1109503	1110576	1110773	1110955	1111586	3103301	6116604
1109078	1109550	1110576H	1110774	1110956	1111591	3103330	6116605
1109079	1109551	1110577	1110780	1110990	1111592	3103331	6116605
1109080	1109552	1110577H	1110781	1110992	1111593	3103332	6116606
1109102	1109553	1110578	1110782	1110994	1111594	3103333	6116606
1109105	1109554	1110578H	1110783	1110995	1111595	3103334	6116607
1109106	1109555	1110582	1110784	1111000	1111610	3103335	6116609
1109107	1109556	1110586	1110785	1111001	1111611	3103336	6116610
1109108	1109557	1110587	1110786	1111002	1111612	3103337	

LIMITED LIFETIME WARRANTY

Warranty to End User: D B Industries, Inc., dba CAPITAL SAFETY USA ("CAPITAL SAFETY") warrants to the original end user ("End User") that its products are free from defects in materials and workmanship under normal use and service. This warranty extends for the lifetime of the product from the date the product is purchased by the End User, in new and unused condition, from a CAPITAL SAFETY authorized distributor. CAPITAL SAFETY'S entire liability to End User and End User's exclusive remedy under this warranty is limited to the repair or replacement in kind of any defective product within its lifetime (as CAPITAL SAFETY in its sole discretion determines and deems appropriate). No oral or written information or advice given by CAPITAL SAFETY, its distributors, directors, officers, agents or employees shall create any different or additional warranties or in any way increase the scope of this warranty. CAPITAL SAFETY will not accept liability for defects that are the result of product abuse, misuse, alteration or modification, or for defects that are due to a failure to install, maintain, or use the product in accordance with the manufacturer's instructions.

CAPITAL SAFETY'S WARRANTY APPLIES ONLY TO THE END USER. THIS WARRANTY IS THE ONLY WARRANTY APPLICABLE TO OUR PRODUCTS AND IS IN LIEU OF ALL OTHER WARRANTIES AND LIABILITIES, EXPRESSED OR IMPLIED. CAPITAL SAFETY EXPRESSLY EXCLUDES AND DISCLAIMS ANY IMPLIED WARRANTIES OF MERCHANTABILITY OR FITNESS FOR A PARTICULAR PURPOSE, AND SHALL NOT BE LIABLE FOR INCIDENTAL, PUNITIVE OR CONSEQUENTIAL DAMAGES OF ANY NATURE, INCLUDING WITHOUT LIMITATION, LOST PROFITS, REVENUES, OR PRODUCTIVITY, OR FOR BODILY INJURY OR DEATH OR LOSS OR DAMAGE TO PROPERTY, UNDER ANY THEORY OF LIABILITY, INCLUDING WITHOUT LIMITATION, CONTRACT, WARRANTY, STRICT LIABILITY, TORT (INCLUDING NEGLIGENCE) OR OTHER LEGAL OR EQUITABLE THEORY.



A Capital Safety Company

CSG USA & Latin America

3833 SALA Way
Red Wing, MN 55066-5005
Toll Free: 800.328.6146
Phone: 651.388.8282
Fax: 651.388.5065
solutions@capitalsafety.com

CSG Canada

260 Export Boulevard
Mississauga, ON L5S 1Y9
Phone: 905.795.9333
Toll-Free: 800.387.7484
Fax: 888.387.7484
info.ca@capitalsafety.com

CSG Northern Europe

Unit 7 Christleton Court
Manor Park
Runcorn
Cheshire, WA7 1ST
Phone: + 44 (0)1928 571324
Fax: + 44 (0)1928 571325
csgne@capitalsafety.com

CSG EMEA (Europe, Middle East, Africa)

Le Broc Center
Z.I. 1ère Avenue
5600 M B.P. 15 06511
Carros
Le Broc Cedex
France
Phone: + 33 4 97 10 00 10
Fax: + 33 4 93 08 79 70
information@capitalsafety.com

CSG Australia & New Zealand

95 Derby Street
Silverwater
Sydney NSW 2128
AUSTRALIA
Phone: +(61) 2 8753 7600
Toll-Free : 1 800 245 002 (AUS)
Toll-Free : 0800 212 505 (NZ)
Fax: +(61) 2 87853 7603
sales@capitalsafety.com.au

CSG Asia

Singapore:
16S, Enterprise Road
Singapore 627666
Phone: +65 - 65587758
Fax: +65 - 65587058
inquiry@capitalsafety.com

Shanghai:

Rm 1406, China Venturetech Plaza
819 Nan Jing Xi Rd,
Shanghai 200041, P R China
Phone: +86 21 62539050
Fax: +86 21 62539060

www.capitalsafety.com



Certificate No. FM 39709