

SPECIFICATIONS

- Very Smooth, Non-Porous Glossy Surface
- Handcrafted with 7mm size tolerance
- Standard 3-1/2" drain opening
- Premium quality ceramic construction
- Extremely resistant to chip, discoloration, scratches, and cracking
- Temperature Resistance: Between 32°F and 250°F



PART#	MODEL	COLOR
2648-0018	H-CF05-00	White

SINK FEATURES

All HIVE sinks receive expert hands-on care under strict quality control throughout every stage of our modern manufacturing process. This ensures a "NO HASSLE" Limited Lifetime Warranty against all manufacturing defects in material and workmanship under normal use.

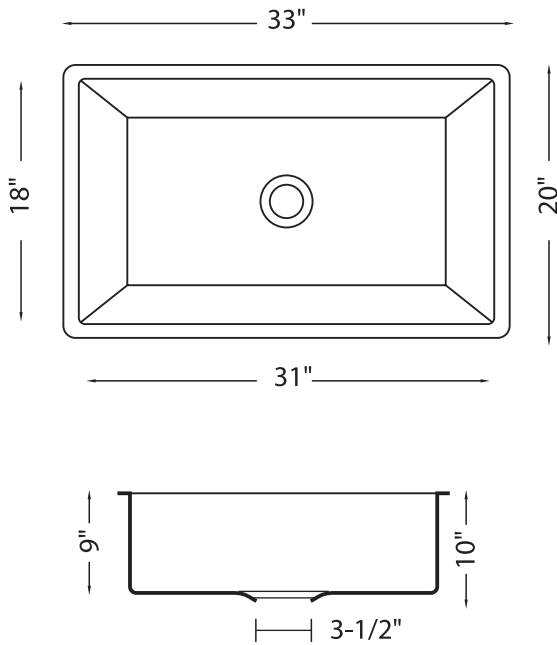
CODE / STANDARDS COMPLIANCE

Most HIVE sinks meet or exceed the following specifications:
 ASME 112.19.3-2008 - IAPMO/UPC listed - CSA B45.4-2008

JOB INFORMATION

JOB NAME: _____ MODEL SPECIFIED: _____ QUANTITY: _____

DATE: _____ ARCHITECT/ENGINEER: _____

CUSTOMER: _____ CONTRACTOR: _____