

*A 5 Year Guarantee Against Weld Failure. A Wesco Quality Exclusive.*

- Industrial strength heavy duty schedule 40 pipe frame construction.
- Ribbed cross braces for extra strength.
- All joints double welded.
- 8" deep by 14" wide nose is 7 gauge thick plate with machined beveled edge and radiused corners for safety.
- Zinc plated Auto-Loc® axles assure smooth wheel rotation.
- All frames handle 8" or 10" wheels.
- Order by part # or model #.

**Example:**

Part # or Model #  
210009 or 126-R

**Wesco Exclusive: Ribbed Cross Straps for Additional Strength**



126-Z



**Series 126**

- Single pin handle curved back design allows one hand control.
- Ideal for boxes, kegs, and packages.
- Three horizontal cross straps and full height vertical center strap offer support for small packages.

OVERALL DIMENSIONS

w: 22.5"  
h: 46"  
d: 16.5" w/8" wheel 18.5" w/10" wheel



126D-Z8



**Series 126D**

- Single "D" shaped handle allows multiple hand positions for one hand control.
- Ideal for boxes, kegs, and packages.
- Three horizontal cross straps and full height vertical center strap provide support for small packages.

OVERALL DIMENSIONS

w: 22.5"  
h: 46"  
d: 16.5" w/8" wheel 18.5" w/10" wheel



136-Z



**Series 136**

- Two handle tapered body design.
- Three heavy duty horizontal cross straps for added strength.
- Full height center strap provides support for small packages.

OVERALL DIMENSIONS

w: 22.5"  
h: 48"  
d: 16.5" w/8" wheel 18.5" w/10" wheel

Part #	210009	210010	210011	210380	210012	210370	210016	210017	210018	210381	210019	210371	210024	210025	210026	210382	210027	210372
Model #	126-R	126-Z8	126-Z	126-Z2	126-P	126-PE	126D-R	126D-Z8	126D-Z	126D-Z2	126D-P	126D-PE	136-R	136-Z8	136-Z	136-Z2	136-P	136-PE
Capacity	800 lbs	500 lbs	700 lbs	800 lbs	700 lbs	600 lbs	800 lbs	500 lbs	700 lbs	800 lbs	700 lbs	600 lbs	800 lbs	500 lbs	700 lbs	800 lbs	700 lbs	600 lbs
Wheel Type	R	Z8	Z	Z2	P	PE	R	Z8	Z	Z2	P	PE	R	Z8	Z	Z2	P	PE
Weight	32 lbs	38 lbs	40 lbs	40 lbs	37 lbs	34 lbs	33 lbs	39 lbs	41 lbs	41 lbs	38 lbs	35 lbs	33 lbs	39 lbs	41 lbs	40 lbs	39 lbs	34 lbs

Additional choices not listed above.

R Aluminum 8" x 1.625" Moldon Rubber	Z8 Poly Offset 8" x 2.0" Solid Rubber	Z Steel Offset 10" x 2.75" Semi-Pneumatic	Z2 Poly Offset 10" x 2.75" Solid Rubber	P Steel Offset 10" x 3.5" Pneumatic	PE Steel Offset 10" x 3.5" Pneumatic	BC-8 Poly Hub 8" x 2.165" Balloon Cushion	BC-10 Poly Hub 10" x 2.165" Balloon Cushion	Flat Free Steel Offset 10" x 3" Microcellular
108545	052862	150589	150698	050602	151505	150229	150228	053446

# WESCO® 100 SERIES INDUSTRIAL HAND TRUCKS

**A 5 Year Guarantee Against Weld Failure. A Wesco Quality Exclusive.**  
**Wesco Exclusive: Ribbed Cross Straps for Additional Strength**



146-R

## Series 146

- Two handle extra high back curved design.
- Ideal for high loads.
- Four horizontal cross straps and vertical center strap provide support for small packages.

### OVERALL DIMENSIONS

w: 22.5"  
 h: 51"  
 d: 16.5" w/8" wheel 18.5" w/10" wheel



146D-Z8

## Series 146D

- Single "D" shaped handle combined with high back curved design.
- Easier one hand control of stacked goods.
- Four horizontal cross straps and vertical center strap provide support for small packages.

### OVERALL DIMENSIONS

w: 22.5"  
 h: 51"  
 d: 16.5" w/8" wheel 18.5" w/10" wheel



156-Z

## Series 156

- Swept back continuous handle with curved back design.
- Very popular frame that allows one or two hand control.
- Four horizontal cross straps and vertical center strap provide support for small packages.

### OVERALL DIMENSIONS

w: 22.5"  
 h: 48"  
 d: 16.5" w/8" wheel 18.5" w/10" wheel

Part #	210032	210033	210034	210383	210035	210373	210038	270056	210039	210384	210040	210374	210044	210045	210046	210385	210047	210375
Model #	146-R	146-Z8	146-Z	146-Z2	146-P	146-PE	146D-R	146D-Z8	146D-Z	146D-Z2	146D-P	146D-PE	156-R	156-Z8	156-Z	156-Z2	156-P	156-PE
Capacity	800 lbs	500 lbs	700 lbs	800 lbs	700 lbs	600 lbs	800 lbs	500 lbs	700 lbs	800 lbs	700 lbs	600 lbs	800 lbs	500 lbs	700 lbs	800 lbs	700 lbs	600 lbs
Wheel Type	R	Z8	Z	Z2	P	PE	R	Z8	Z	Z2	P	PE	R	Z8	Z	Z2	P	PE
Weight	34 lbs	40 lbs	42 lbs	42 lbs	39 lbs	36 lbs	35 lbs	41 lbs	43 lbs	42 lbs	41 lbs	36 lbs	31 lbs	37 lbs	39 lbs	40 lbs	36 lbs	34 lbs

## 100 Series Industrial Hand Truck Options



### Nose Extension

- 24" long, 10.5" wide.
- Steel construction.



### Stairclimber

- Continuous belt.
- Replaceable parts.
- Only available on 10" wheeled models.
- Factory installed only.



**NEW!**  
 Patent Pending



### Cargo Push-Off Kit

- Fits any Wesco 100 Series or Greenline Series steel hand trucks.
- Foot operated pedal pushes cargo off noseplate.
- Easy installation - no drilling required.

Part #	210099	054201	270412	210079
Model #	FN-24K	FN-24F	CBSCF	

24" Nose Extension - Field Installation

24" Nose Extension - Factory Installed

Continuous belt stairclimber  
 Must be Factory Installed

Box Push Off - Field Installation

**FACTORY INSTALLED add part # or model # to end of industrial hand truck part or model #.**

**Example:** 156R with 24" nose extension  
 Part # 210044,054201 or  
 Model #156-R-FN-24F

**Additional choices not listed above.**

R Aluminum 8" x 1.625" Moldon Rubber	Z8 Poly Offset 8" x 2.0" Solid Rubber	Z Steel Offset 10" x 2.75" Semi-Pneumatic	Z2 Poly Offset 10" x 2.75" Solid Rubber	P Steel Offset 10" x 3.5" Pneumatic	PE Steel Offset 10" x 3.5" Pneumatic	BC-8 Poly Hub 8" x 2.165" Balloon Cushion	BC-10 Poly Hub 10" x 2.165" Balloon Cushion	Flat Free Steel Offset 10" x 3" Microcellular
108545	052862	150589	150698	050602	151505	150229	150228	053446

HAND TRUCKS



156-S25-Z2

## 2-in-1 Deluxe Industrial Steel Hand Trucks

### 5 Year Weld Guarantee.

- Converts easily between 2 and 4 wheel truck.
- Handle locks in horizontal and vertical positions.
- Two lengthwise straps and two cross braces prevent package fall-through.
- 3.5" or 5" Colson Hi-Tech Performa Casters—A Wesco Exclusive.
- Heavy duty 3/4" sch. 40 structural pipe frame. All joints double welded, both sides.
- Bed size: 14" x 44.5".

### Colson Hi-Tech Performa Casters

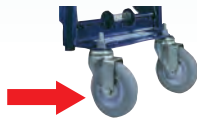

5" Caster

- Standard equipment on all models at no additional cost.
- Less energy required to start moving load and keep it moving.
- Performa wheels reject almost every type of floor debris, including metal shavings, chips, sand and gravel.
- Smooth, quiet ride of a soft-tread wheel.
- As durable as a hard-tread wheel.

#### OVERALL DIMENSIONS

w: 22.5"  
h: 53"  
d: 19"

## 2-4-1 Convertible Truck

- Extra large 20"W x 7 1/2" deep noseplate.
- Quick release latch for easy conversion from 2-wheel to 4-wheel mode.
- Steel frame aluminum handle.
- Bed size 13.125" x 39".

- Converts easily between 2 and 4 wheel truck.
- Double welded tubular construction.
- Lengthwise strap and cross braces prevent package fall-through.
- Solid rubber swivel casters.
- Bed size 13" x 36".

#### OVERALL DIMENSIONS

w: 22.5"  
h: 53"  
d: 23"

## Greenline Economical 2-in-1

- Converts easily between 2 and 4 wheel truck.
- Double welded tubular construction.
- Lengthwise strap and cross braces prevent package fall-through.
- Solid rubber swivel casters.
- Bed size 13" x 36".

#### OVERALL DIMENSIONS

w: 20"  
h: 48"  
d: 17.75"

**For Aluminum Convertible Trucks, see pages 34-36.**



656-21-Z



656-21-Q



E-CON



## Greenline E-Con 2-in-1 Truck

- Heavy duty tubular steel construction.
- 18" w x 8.5" d. noseplate.
- Lever activated position conversion.
- Wheel guards.
- Bed size 13.75" x 48".

#### OVERALL DIMENSIONS

w: 19.625"  
h: 58.25"  
d: 20.25"



GDA21



## Greenline DU-ALL Economy Convertible 2-in-1

- Converts between 2 and 4 wheel positions.
- Steel tubular frame construction
- Ships KD, minor assembly required.
- Bed size 13.75" x 46".

#### OVERALL DIMENSIONS

w: 20"  
h: 53"  
d: 19"

Part #	210138	210140	210139	210144	210141	210143	272997	210323	210324	210326	210325	210639	210477
Model #	156-S23-Z	156-S23-Z2	156-S23-P	156-S25-Z	156-S25-Z2	156-S25-P	2-4-1-CON	656-21-Q	656-21-Z	656-21-Z2	656-21PE	E-CON	GDA21
Capacity 2 wheel	700 lbs	800 lbs	700 lbs	700 lbs	800 lbs	700 lbs	700 lbs	300 lbs	500 lbs	500 lbs	500 lbs	700 lbs	500 lbs
Capacity 4 wheel	1,000 lbs	1,000 lbs	1,000 lbs	1,000 lbs	1,000 lbs	1,000 lbs	800 lbs	400 lbs	600 lbs	600 lbs	600 lbs	800 lbs	600 lbs
Caster	3.5"	3.5"	3.5"	5"	5"	5"	5"	3"	5"	5"	5"	5"	3.5"
Wheel Type	Z	Z2	P	Z	Z2	P	12" Pneumatic # 172232	Q	Z	Z2	PE	10" x 2.5" Solid Rubber	Z
Weight	60.5 lbs	58.25 lbs	55.25 lbs	61.5 lbs	60 lbs	56.25 lbs	45 lbs	37 lbs	46 lbs	38 lbs	44 lbs	77 lbs	52 lbs

Additional choices not listed above.

Z	Z2	P	PE	Q	BC-8	BC-10	Flat Free
Steel Offset 10" x 2.75" Semi-Pneumatic	Poly Offset 10" x 2.75" Solid Rubber	Steel Offset 10" x 3.5" Pneumatic	Steel Offset 10" x 3.5" Pneumatic	Poly 8" x 1.75" Semi Pneumatic	Poly Hub 8" x 2.165" Balloon Cushion	Poly Hub 10" x 2.165" Balloon Cushion	Steel Offse 10" x 3"
150589	150698	050602	151505	150225	150229	150228	053446

- **Economically priced.**
- **500 lb frame capacity.**
- **Green enamel finish.**
- **Zinc plated Auto-Loc® axles assure smooth wheel rotation.**
- **All frames can accommodate an 8" or 10" wheel.**
- **7" deep x 14" wide 7 gauge beveled nose plate with radiused corners for safety.**

- **1" OD x 14 gauge wall tubular frame.**
  - **Order by part # or model #.**
- Example:**

Part # or Model #  
210461 626-Q

**For Heavy Duty USA Made Hand Trucks, see page 16.**

126-Z 126D-Z8 136-Z



626-Q

## Series 626

- Pin handle with curved back design.
- Welded frame construction.
- 1" O.D. tube.

**OVERALL DIMENSIONS**

w: 21.75"  
h: 45.5"  
d: 17"



626D-R

## Series 626D

- Single loop handle with curved back design.
- Welded frame construction.
- 1" O.D. tube.

**OVERALL DIMENSIONS**

w: 21.75"  
h: 50.5"  
d: 17"



636-Z8

## Series 636

- Dual handle curved back design.
- Welded frame construction.
- 1" O.D. tube.

**OVERALL DIMENSIONS**

w: 21.75"  
h: 48.5"  
d: 17"

Part #	210461	210466	210330	210361	210456	210356	210462	210467	210331	210362	210457	210357	210463	210468	210332	210363	210458	210358
Model #	626-Q	626-R	626-Z8	626-Z2	626-P	626-PE	626D-Q	626D-R	626D-Z8	626D-Z2	626D-P	626D-PE	636-Q	636-R	636-Z8	636-Z2	636-P	636-PE
Capacity	300 lbs	500 lbs	500 lbs	500 lbs	500 lbs	500 lbs	300 lbs	500 lbs	500 lbs	500 lbs	500 lbs	500 lbs	300 lbs	500 lbs	500 lbs	500 lbs	500 lbs	500 lbs
Wheel Type	Q	R	Z8	Z2	P	PE	Q	R	Z8	Z2	P	PE	Q	R	Z8	Z2	P	PE
Weight	24 lbs	25.5 lbs	25.5 lbs	31 lbs	27.5 lbs	26 lbs	25.5 lbs	27 lbs	27 lbs	32.5 lbs	29 lbs	27.5 lbs	24.5 lbs	26 lbs	26 lbs	31.5 lbs	28 lbs	26.5 lbs

**Additional choices not listed above.**

<b>Q</b> Poly Offset 8" x 1.75" Semi-Pneumatic	<b>R</b> Aluminium 8" x 1.625" Moldon Rubber	<b>Z8</b> Poly Offset 8" x 2" Solid Rubber	<b>Z2</b> Poly Offset 10" x 2.75" Solid Rubber	<b>P</b> Steel Offset 10" x 3.5" Pneumatic	<b>PE</b> Steel Offset 10" x 3.5" Pneumatic	<b>BC-8</b> Poly Hub 8" x 2.165" Balloon Cushion	<b>BC-10</b> Poly Hub 10" x 2.165" Balloon Cushion	<b>Flat Free</b> Steel Offset 10" x 3" Microcellular
151225	108545	052862	150698	050602	151505	150229	150228	053446



## Cargo Push-Off Kit

- Fits any Wesco 100 Series or Greenline Series steel hand trucks.
- Foot operated pedal pushes cargo off noseplate.
- Easy installation - no drilling required.
- **Part # 210079.**

**For Heavy Duty USA Made Hand Trucks, see page 17.**



646-Z2

## Series 646

- Dual pin handle with curved back design.
- Welded frame construction.
- 1" O.D. tube.

### OVERALL DIMENSIONS

w: 21.75"  
h: 50.5"  
d: 20"



656-P

## Series 656

- Continuous handle with curved back design.
- Welded frame construction.
- 1" O.D. tube.

### OVERALL DIMENSIONS

w: 21.75"  
h: 49"  
d: 19"



636-Z8 with folding nose

## Folding Nose Extension Option

- To order field installation simply note part # or model # on P.O.
- To order factory installed option (626D-R with 24" nose extension) add option part # or model to the end of the truck part # or model.

### Example:

Part # 210467,054218  
or  
Model + Option  
626D-R-FNG-24F

Part #	210464	210469	210333	210364	210459	210359	210465	210470	210334	210365	210460	210360
Model #	646-Q	646-R	646-Z8	646-Z2	646-P	646-PE	656-Q	656-R	656-Z8	656-Z2	656-P	656-PE
Capacity	300 lbs	500 lbs	500 lbs	500 lbs	500 lbs	500 lbs	300 lbs	500 lbs	500 lbs	500 lbs	500 lbs	500 lbs
Wheel Type	Q	R	Z8	Z2	P	PE	Q	R	Z8	Z2	P	PE
Weight	25.5 lbs	27 lbs	27 lbs	32.5 lbs	29 lbs	27.5 lbs	26 lbs	27.5 lbs	27.5 lbs	33 lbs	29.5 lbs	28 lbs

210249	054218
FNG-24K	FNG-24F

Capacity rating same as truck.  
Field Installation      Factory Installed

### Additional choices not listed above.

Q Poly Offset 8" x 1.75" Semi-Pneumatic	R Aluminium 8" x 1.625" Moldon Rubber	Z8 Poly Offset 8" x 2" Solid Rubber	Z2 Poly Offset 10" x 2.75" Solid Rubber	P Steel Offset 10" x 3.5" Pneumatic	PE Steel Offset 10" x 3.5" Pneumatic	BC-8 Poly Hub 8" x 2.165" Balloon Cushion	BC-10 Poly Hub 10" x 2.165" Balloon Cushion	Flat Free Steel Offset 10" x 3" Microcellular
151225	108545	052862	150698	050602	151505	150229	150228	053446

*A 5 Year Guarantee Against Weld Failure. A Wesco Quality Exclusive.*

## The Touch-N-Tilt® Ergonomic Hand Truck

*has a patented load break over feature. Press the pedal and the effort to break over the load is reduce by as much as 66%. Minimizes physical demands of the workplace.*

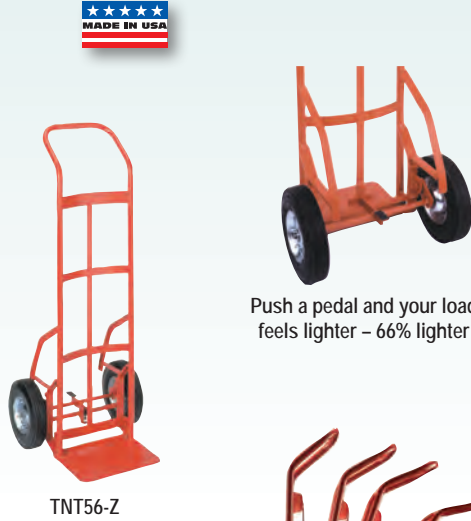

TNT56-Z

Push a pedal and your load feels lighter – 66% lighter

### Touch-N-Tilt®

- U.S. Patent 5,118,124.
- Simple and affordable.
- Up to 700 lbs. capacity.
- Available with 8" or 10" wheels.
- Same strong frames used on Wesco 100 series industrial truck.
- Noseplate 7 GA. 8" D x 14" W.

#### OVERALL DIMENSIONS

w: 22.5"  
h: 48"  
d: 18.75" w/8" wheel 19.75" /10" wheel

## Freight King® Features:

- Replaceable hardwood handles are essential for use in cold environments.
- Frame made from one piece heavy gauge pressed steel.
- Frame is reinforced at critical points.
- Bolted construction for easy parts replacement.
- Beveled open 5" or 8" nose is made of .5" thick steel.
- Red enamel finish.



T-1-8



T-1 + FN-21F

## Standard Freight King

- Curved handles.
- 6" x 1.5" cast iron center moldon rubber wheels with .75" ball bearings. Part # 108838
- 450 lb capacity.

#### OVERALL DIMENSIONS

w: 18.5" 18.5"  
h: 46" 46"  
d: 20" 23"

## Freight King Folding Nose Option

- 21" long x 12.75".
- To order option, add part # or model to truck.

#### Example:

Part # 210090, 054200

or

Model + Option  
T-1 + FN21F

Part #	210544	210545	210546	210549	210547	210548	210090	210092	210100	054200
Model #	TNT56-R	TNT56-Z8	TNT56-Z	TNT56-Z2	TNT56-P	TNT56-PE	T-1	T-1-8	FN-21K	FN-21F
Capacity	600 lbs	500 lbs	600 lbs	700 lbs	600 lbs	600 lbs	450 lbs	450 lbs	450 lbs	450 lbs
Wheel Type	R	Z8	Z	Z2	P	PE	6" x 1.5" Cast Iron Center Moldon Rubber		Kit Field Install N/A	Factory Install N/A
Weight	33.5 lbs	39.5 lbs	41.5 lbs	41.5 lbs	38.5 lbs	35.5 lbs	30 lbs	31 lbs	7 lbs	7 lbs

### Additional choices not listed above.

R	Z8	Z	Z2	P	PE	BC-8	BC-10	Flat Free
Aluminum 8" x 1.625" Moldon Rubber	Poly Offset 8" x 2.0" Solid Rubber	Steel Offset 10" x 2.75" Semi-Pneumatic	Poly Offset 10" x 2.75" Solid Rubber	Steel Offset 10" x 3.5" Pneumatic	Steel Offset 10" x 3.5" Pneumatic	Poly Hub 8" x 2.165" Balloon Cushion	Poly Hub 10" x 2.165" Balloon Cushion	Steel Offset 10" x 3" Microcellular
108545	052862	150589	150698	050602	151505	150229	150228	053446

# WESCO HEAVY DUTY STEEL HAND TRUCKS

*A 5 Year Guarantee Against Weld Failure. A Wesco Quality Exclusive.*



156DH-Z

## 156DH Drum/Hand Truck

- Utility of a hand truck & drum truck.
- Chime hook works with 55 and 30 gallon drums.
- Curved frame holds 5 gallon pails and kegs.
- With noseplate resting flat on floor, 18" to center of lowered chime hook.

OVERALL DIMENSIONS		
w: 20.5"	20.5"	20.5"
h: 48"	48"	48"
d: 18.5"	17.5"	18.5"



Oversized 12" pneumatic tire for easy mobility on rough terrain.



ST2-P12

## Heavy Duty Shovel Nose Trucks

- Five year weld guarantee.
- 13" deep x 17.5" x .25" thick tapered nose plate.
- 1" heavy duty Sch-40 pipe frame.
- Easy grip continuous handle frame design.
- 3/4" axle.
- Wheel guards.
- 2 wheel types - 10" & 12".

OVERALL DIMENSIONS	
w: 20.5"	20.5"
h: 53"	53"
d: 22"	25.5"



186-Z

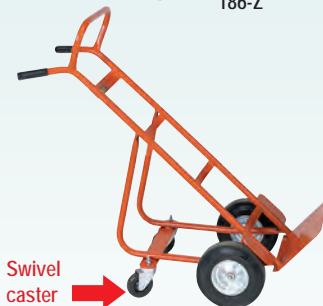

186-ZC

Swivel caster →

## Heavy Duty 186 Series

- Rear axle designs allow loading and unloading of pallets. Rear caster design allows small diameter turns in tight areas.
- Combination two handle and utility bar handle design.
- Distribution of load over 4 wheels improves load control.
- All wheels have ball bearings.
- Wheel guards.

OVERALL DIMENSIONS		
w: 21"	22"	20.5"
h: 47.5"	51"	47.5"
d: 26"	26"	26"
NOSE PLATE		
d: 8"	13"	8"



146RN-HB

Steel Reinforced on underside of nose plate.

## Heavy Duty Hand Truck

- 8" x 2" cast iron center moldon rubber wheels.
- Steel reinforced nose plate.
- .75 inch axle.
- Five handle choices.

### OVERALL DIMENSIONS

w: 19.625"  
h: 51"  
d: 17.5"

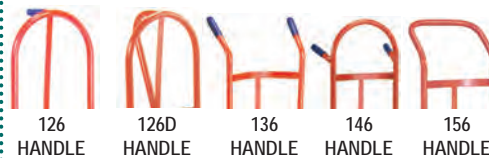

126 HANDLE 126D HANDLE 136 HANDLE 146 HANDLE 156 HANDLE

Part #	210340	210349	210266	210064	210066	210050	210051	210125	210263	210264	210134	210135	210265
Model #	156DH-Z	156DH-HB	156DH-P	ST-2HB	ST2-P12	186-Z	186-RK8	186-ZC	126RN-HB	126DRN-HB	136RN-HB	146RN-HB	156RN-HB
Capacity	700 lbs	800 lbs	700 lbs	900 lbs	800 lbs	800 lbs	900 lbs	800 lbs	800 lbs	800 lbs	800 lbs	800 lbs	800 lbs
Wheel: Front	Z	HB	P	HB	P-12"	Z	8" x 2.5" Balloon Cushion	Z	HB	HB	HB	HB	HB
Rear	N/A	N/A	N/A	N/A	N/A	6" Moldon Rubber/ Axle	6" Moldon Rubber/ Axle	4" x 1.25" Poly/Swivel	N/A	N/A	N/A	N/A	N/A
Weight	39 lbs	42.5 lbs	39 lbs	59.5 lbs	61 lbs	53 lbs	59 lbs	53 lbs	39 lbs	40 lbs	40 lbs	40 lbs	38 lbs

- 5 year weld guarantee.
- All joints double welded.
- Schedule 40 pipe frame construction.
- Ribbed x-braces for added strength.

Additional choices not listed above.

Z	HB	P	P-12	BC-8	BC-10	Flat Free
Steel Offset 10" x 2.75" Semi-Pneumatic	Cast Iron 8" x 2" Moldon Rubber	Steel Offset 10" x 3.5" Pneumatic	Steel Offset 12" x 4"	Poly Hub 8" x 2.165" Balloon Cushion	Poly Hub 10" x 2.165" Balloon Cushion	Steel Offset 10" x 3" Microcellular
150589	150120	050602	108484	150229	150228	053446



## 5 Year Weld Guarantee



TM-HB



TM4W-HB

### Heavy Duty Warehouse Trucks:

- **Five year weld guarantee.**
- Large 10" deep x 16.5" wide x .25" thick tapered nose plate.
- 1" heavy duty Sch-40 pipe frame.
- Wheel guards standard.
- Dual handle design.
- Kick out four wheel model – TM4W or standard two wheel model.
- 3.5" moldon rubber swivel casters on four wheel kick out trucks.
- **New longer 14 ft. belt length on TM4W models.**

OVERALL DIMENSIONS			OVERALL DIMENSIONS		
w: 21"	21"	21"	w: 20.5"	20.5"	20.5"
h: 50.5"	50.5"	50.5"	h: 37.25"	4-Wheel / 50.25 2 Wheel	
d: 22.5"	23.5"	24"	d: 22.5"	22"	22"



CT-401

### Steel Collaps-A-Trucks

- All welded construction.
- Collapses for convenient storage and portability.
- Ideal for salesmen, delivery men, or repairmen.
- Folding noseplate - 14" W x 6" D.
- Folding nose extension - 14" W x 10.5" D.

OVERALL DIMENSIONS
w: 12"
h: 43.75"
d: 15"



SR1-Z

### SideRoller

- Standard hand truck or side rolling cart capability.
- **Side rolling position allows wide product loads to fit through narrow doorways.**
- Wheels maintain full contact with the floor in both transport positions.
- Spring loaded locking mechanism provides greater steering control and stability.
- 7" nose plate depth.

OVERALL DIMENSIONS
w: 22.25"
h: 48.211"
d: 20"



210123  
2-wheel mode



210124  
4-wheel mode

### Professional Series Cylinder Trucks

- Safety chain secures load.
- Easy conversion between all 3 modes using spring-loaded position lock mechanism.
- 8" moldon rubber wheels, 3" swivel casters.
- Holds cylinders up to 9 1/4" in. diameter.
- Noseplate 9" w x 7 1/4" d - single cylinder.
- Noseplate 16 7/8" w x 7 1/4" d - double cylinder.

#### 4-WHEEL OVERALL DIMENSIONS

w: 19"	29"
h: 36.5"	37"
d: 32"	32"

#### 2-WHEEL OVERALL DIMENSIONS

w: 19"	29"
h: 41.75"	42.25"
d: 17.5"	18.5"

#### STORAGE OVERALL DIMENSIONS

w: 19"	29"
h: 41.75"	42.25"
d: 26"	26"

Part #	210055	210056	210239	210060	210061	210062	210218	210270	210123	210124
Model #	TM-HB	TM-PB	TM-BT	TM4W-HB	TM4W-PB	TM4W-BT	CT-401	SR1-Z	CC-1	CC-2
Capacity	900 lbs	700 lbs	1,000 lbs	900 lbs	700 lbs	1,000 lbs	200 lbs	500 lbs	250 lbs	500 lbs
Wheel Type	HB	PB	BT	HB	PB	BT	5" x 1.25" Polyolefin	Z	8" Moldon Rubber	8" Moldon Rubber
Caster	N/A	N/A	N/A	3.5"	3.5"	3.5"	N/A	N/A	3"	3"
Weight	54 lbs	49 lbs	67 lbs	66 lbs	61 lbs	79 lbs	98 lbs	38.5 lbs	40 lbs	50 lbs

HB	PB	BT	Z
Cast Iron 8" x 2"	Steel Offset 10" x 3.5"	Cast Iron 10" x 2.5"	Steel Offset 10" x 2.75"
Moldon Rubber	Pneumatic	Moldon Rubber	Semi-Pneumatic
050579	108478	150596	150589

**File Cabinet Hand Truck—**  
see page 86.



**Hydraulic Cylinder Lift Truck—**  
see page 57.







210127

## SR Economy Hand Truck

- 7.5" x 14" nose plate.
- 16 gauge frame.
- Two Wheel Choices:  
10" Pneumatic and  
10" Solid Rubber Wheels.
- Ships KD.

### OVERALL DIMENSIONS

w: 21.5"	w: 21.5"
h: 51"	h: 51"
d: 19"	d: 19"



210479



## Tilting and Folding Fork Hand Truck

- Folding fork 4"W x 12"L.
- Hinged forks slide under cargo. Standing truck upright locks forks allowing load to be lifted.
- Foot pedal to tilt. Facilitates break over.
- Wheel guards.
- Folded depth 13".
- Stack height 49".
- 10" x 2.5" moldon rubber cast iron wheel.

### OVERALL DIMENSIONS

w: 25.5"
h: 55" straight up
d: 24.25"



210214

## Economy Wide Plate Hand Truck

- Wheel guards and vinyl strips protect cargo.
- 20" wide nose plate.
- Two Wheel Choices:  
10" Pneumatic and  
10" Solid Rubber Wheels.

### OVERALL DIMENSIONS

w: 22"
h: 51.5"
d: 19"



166RN-Z8-FNR-24F  
Shown with optional folding nose.

## High Frame Package Truck

- 8" x 2" solid rubber ball bearing wheels.
- Reinforced frame.
- Folding nose option.  
Field Install - # **FNR-24K**  
Factory Install - # **FNR-24F**

### OVERALL DIMENSIONS

w: 20.375"
h: 55.5"
d: 17"

Part #	210127	210215	210479	210214	210217	210261	210262	054224
Model #	SR Economy	SR Economy	TFT	Wide Plate Economy	Wide Plate Economy SR	166RN-Z8	FNR-24K	FNR-24F
Capacity	500 lbs	500 lbs	1,000 lbs	600 lbs	500 lbs	800 lbs	800 lbs	800 lbs
Wheel	10" Pneumatic	10" Solid Rubber	10" Moldon Rubber	10" Pneumatic	10" Solid Rubber	8" Solid Rubber	N/A	N/A
Weight	26 lbs	40 lbs	83.5 lbs	29 lbs	43 lbs	36 lbs	8 lbs	8 lbs

## Curb Ramp

- Lightweight, portable ramp allows for easy movement up and down curbs. **600 lbs capacity.**



### OVERALL DIMENSIONS

w: 21.5"
h: 6"
d: 23.5"

Part #	150800	150801	150802
Description	Yellow generic	Red CocaCola®	Blue Pepsi®
Weight	7 lbs	7 lbs	7 lbs

*Noseplate Guaranteed for 5 years*

## Mighty-Lite® Features:

- **Super strong nose with 5 year guarantee against breakage.**
- **Heavy duty magnesium frame – the strongest light weight truck available.**
- **Magnesium is 33% lighter than aluminum and is the world's lightest structural metal.**
- **Ships assembled.**
- **Available options include: stairglides, 12" deep noses, folding nose extensions, top extensions, center straps, and hanger hooks (see page 29).**
- **Wheel guards are standard with S14 noseplates.**

■ Order by Part # or Model #.

**Example:**

Part # 220004

or

Series + Nose + Wheel = Model #

500 - S14 - Z



500-S14-Z8

### Series 500

- Super light design.
- Continuous handle.
- Straight back frame.
- S14 Nose: 14" w x 7.625" d.  
S18 Nose: 18" w x 7.625" d.

#### OVERALL DIMENSIONS

w: 18"  
h: 51"  
d: 18"



510-S14-R3

### Series 510

- **Reinforced upper and lower frame for added strength.**
- Continuous handle.
- Straight back frame.
- Comfortable vinyl covered handle at no extra cost.
- S14 Nose: 14" w x 7.625" d.  
S18 Nose: 18" w x 7.625" d.

#### OVERALL DIMENSIONS

w: 18"  
h: 51"  
d: 18"

S14" Nose Part #	220003	220002	220004	220246	220005	220261	220013	220012	220014	220248	220015	220263
Model #	500-S14-Z8	500-S14-R3	500-S14-Z	500-S14-Z2	500-S14-P	500-S14-PE	510-S14-Z8	510-S14-R3	510-S14-Z	510-S14-Z2	510-S14-P	510-S14-PE
Capacity	400 lbs	400 lbs	400 lbs	400 lbs	400 lbs	400 lbs	600 lbs	600 lbs	600 lbs	600 lbs	600 lbs	600 lbs
Wheel Type	Z8	R3	Z	Z2	P	PE	Z8	R3	Z	Z2	P	PE
Weight	23 lbs	20 lbs	28 lbs	26.5 lbs	23 lbs	21.5 lbs	24 lbs	21 lbs	29 lbs	27.5 lbs	24 lbs	22.5 lbs
S18" Nose Part #	220008	220007	220009	220247	220010	220262	220018	220017	220019	220249	220020	220264
Model #	500-S18-Z8	500-S18-R3	500-S18-Z	500-S18-Z2	500-S18-P	500-S18-PE	510-S18-Z8	510-S18-R3	510-S18-Z	510-S18-Z2	510-S18-P	510-S18-PE
Capacity	400 lbs	400 lbs	400 lbs	400 lbs	400 lbs	400 lbs	600 lbs	600 lbs	600 lbs	600 lbs	600 lbs	600 lbs
Wheel Type	Z8	R3	Z	Z2	P	PE	Z8	R3	Z	Z2	P	PE
Weight	25 lbs	22 lbs	30 lbs	28.5 lbs	25 lbs	23.5 lbs	26 lbs	23 lbs	31 lbs	29.5 lbs	26 lbs	24.5 lbs

#### Additional choices not listed above.

Z8	R3	Z	Z2	P	PE	BC-8	BC-10	Flat Free
Poly Offset 8" x 2"	Aluminum Offset 8" x 1.625"	Steel Offset 10" x 2.75"	Poly Offset 10" x 2.75"	Steel Offset 10" x 3.5"	Steel Offset 10" x 3.5"	Poly Hub 8" x 2.165"	Poly Hub 10" x 2.165"	Steel Offset 10" x 3"
Solid Rubber	Moldon Rubber	Semi-Pneumatic	Solid Rubber	Pneumatic	Pneumatic	Balloon Cushion	Balloon Cushion	Microcellular
150697	108561	150589	150698	050602	151505	150229	150228	053446



*Noseplate Guaranteed for 5 years*



520-S14-Z

## Series 520

- Straight, high back frame for tall loads.
- Heavy duty pin handle for one handed control.
- Reinforced lower frame.
- Comfortable vinyl hand grip.
- S14 Nose: 14" w x 7.625" d.
- S18 Nose: 18" w x 7.625" d.

### OVERALL DIMENSIONS

w: 18"  
h: 52"  
d: 20"



525-C14-Z2

## Series 525\*

- Open back nose plate and curved frame.
- Excellent for kegs and other cylindrical objects.
- High back frame for tall loads.
- Heavy duty pin handle.
- Reinforced lower frame.
- Comfortable vinyl hand grip.
- C14 Nose: 14" w x 7.625" d.

### OVERALL DIMENSIONS

w: 18"  
h: 52"  
d: 20"

*\*Open back nose plate only available as C14" nose.*

S14" Nose Part #	220023	220022	220024	220250	220025	220265	220033	220032	220034	220252	220035	220267
Model #	520-S14-Z8	520-S14-R3	520-S14-Z	520-S14-Z2	520-S14-P	520-S14-PE	525-C14-Z8	525-C14-R3	525-C14-Z	525-C14-Z2	525-C14-P	525-C14-PE
Capacity	600 lbs	600 lbs	600 lbs	600 lbs	600 lbs	600 lbs	600 lbs	600 lbs	600 lbs	600 lbs	600 lbs	600 lbs
Wheel Type	Z8	R3	Z	Z2	P	PE	Z8	R3	Z	Z2	P	PE
Weight	24 lbs	21 lbs	29 lbs	27.5 lbs	24 lbs	22.5 lbs	23.5 lbs	20.5 lbs	28.5 lbs	27 lbs	23.5 lbs	22 lbs

S18" Nose Part #	220028	220027	220029	220251	220030	220266
Model #	520-S18-Z8	520-S18-R3	520-S18-Z	520-S18-Z2	520-S18-P	520-S18-PE
Capacity	600 lbs	600 lbs	600 lbs	600 lbs	600 lbs	600 lbs
Wheel Type	Z8	R3	Z	Z2	P	PE
Weight	26 lbs	23 lbs	31 lbs	29.5 lbs	26 lbs	24.5 lbs

**Additional choices not listed above.**

Z8	R3	Z	Z2	P	PE	BC-8	BC-10	Flat Free
Poly Offset 8" x 2"	Aluminum Offset 8" x 1.625"	Steel Offset 10" x 2.75"	Poly Offset 10" x 2.75"	Steel Offset 10" x 3.5"	Steel Offset 10" x 3.5"	Poly Hub 8" x 2.165"	Poly Hub 10" x 2.165"	Steel Offset 10" x 3"
Solid Rubber	Moldon Rubber	Semi-Pneumatic	Solid Rubber	Pneumatic	Pneumatic	Balloon Cushion	Balloon Cushion	Microcellular
150697	108561	150589	150698	050602	151505	150229	150228	053446



**Noseplate Guaranteed for 5 years**

## Series 530\*

- Open back nose plate and curved frame.
- Excellent for kegs and other cylindrical objects.
- Super light design.
- Economical cost.
- Continuous handle.
- C14 Nose: 14" w x 7.625" d.



530-C14-P

### OVERALL DIMENSIONS

w: 18"  
h: 51"  
d: 20"

*\*Open back nose plate only available as C14" nose.*

## Series 540\*

- Open back nose plate and curved frame.
- Excellent for kegs and other cylindrical objects.
- Reinforced upper frame for added strength.
- Continuous handle.
- Comfortable vinyl covered handle at no extra cost.
- C14 Nose: 14" w x 7.625" d.



540-C14-P

### OVERALL DIMENSIONS

w: 18"  
h: 51"  
d: 20"

*\*Open back nose plate only available as C14" nose.*

S14" Nose Part #	220038	220037	220039	220253	220040	220268	220043	220042	220044	220254	220045	220269
Model #	530-C14-Z8	530-C14-R3	530-C14-Z	530-C14-Z2	530-C14-P	530-C14-PE	540-C14-Z8	540-C14-R3	540-C14-Z	540-C14-Z2	540-C14-P	540-C14-PE
Capacity	400 lbs	400 lbs	400 lbs	400 lbs	400 lbs	400 lbs	600 lbs	600 lbs	600 lbs	600 lbs	600 lbs	600 lbs
Wheel Type	Z8	R3	Z	Z2	P	PE	Z8	R3	Z	Z2	P	PE
Weight	23 lbs	20 lbs	28 lbs	26.5 lbs	23 lbs	21.5 lbs	23.5 lbs	20.5 lbs	28.5 lbs	27 lbs	23.5 lbs	22 lbs



## Series 560\*

- Open back nose plate and curved frame.
- Excellent for kegs and other cylindrical objects.
- Twin handles for two handed load control.
- Reinforced upper frame for added strength.
- Comfortable vinyl hand grips.
- C14 Nose: 14" w x 7.625" d.



560-C14-R3

### OVERALL DIMENSIONS

w: 18"  
h: 49"  
d: 20"

*\*Open back nose plate only available as C14" nose.*



## Series 575\*

- Open back nose plate and curved frame.
- Excellent for kegs and other cylindrical objects.
- High back frame for tall loads.
- Heavy duty safety loop handle design for one handed control.
- Reinforced upper and lower frame for added strength.
- C14 Nose: 14" w x 7.625" d.



575-C14-Z2

### OVERALL DIMENSIONS

w: 18"  
h: 52"  
d: 20"

*\*Open back nose plate only available as C14" nose.*

S14" Nose Part #	220058	220057	220059	220257	220060	220272	220073	220072	220074	220260	220075	220275
Model #	560-C14-Z8	560-C14-R3	560-C14-Z	560-C14-Z2	560-C14-P	560-C14-PE	575-C14-Z8	575-C14-R3	575-C14-Z	575-C14-Z2	575-C14-P	575-C14-PE
Capacity	600 lbs	600 lbs	600 lbs	600 lbs	600 lbs	600 lbs	600 lbs	600 lbs	600 lbs	600 lbs	600 lbs	600 lbs
Wheel Type	Z8	R3	Z	Z2	P	PE	Z8	R3	Z	Z2	P	PE
Weight	23.5 lbs	20.5 lbs	28.5 lbs	27 lbs	23.5 lbs	22 lbs	24 lbs	21 lbs	29 lbs	27.5 lbs	24 lbs	22.5 lbs

**Additional choices not listed above.**

Z8	R3	Z	Z2	P	PE	BC-8	BC-10	Flat Free
Poly Offset 8" x 2"	Aluminum Offset 8" x 1.625"	Steel Offset 10" x 2.75"	Poly Offset 10" x 2.75"	Steel Offset 10" x 3.5"	Steel Offset 10" x 3.5"	Poly Hub 8" x 2.165"	Poly Hub 10" x 2.165"	Steel Offset 10" x 3"
Solid Rubber	Moldon Rubber	Semi-Pneumatic	Solid Rubber	Pneumatic	Pneumatic	Balloon Cushion	Balloon Cushion	Microcellular
150697	108561	150589	150698	050602	151505	150229	150228	053446



*Noseplate Guaranteed for 5 years*



550-S14-Z

## Series 550

- Reinforced upper and lower frame for added strength.
- Straight back frame.
- Twin handles for two handed load control.
- Comfortable vinyl hand grips.
- S14 Nose: 14" w x 7.625" d.  
S18 Nose: 18" w x 7.625" d.

### OVERALL DIMENSIONS

w: 18"  
h: 49"  
d: 20"



570-S14-Z

## Series 570

- High back frame for tall loads.
- Straight back frame.
- Heavy duty safety loop handle design for one handed control.
- Reinforced upper and lower frame for added strength.
- S14 Nose: 14" w x 7.625" d.  
S18 Nose: 18" w x 7.625" d.

### OVERALL DIMENSIONS

w: 18"  
h: 52"  
d: 20"

S14" Nose Part #	220048	220047	220049	220255	220050	220270	220063	220062	220064	220258	220065	220273
Model #	550-S14-Z8	550-S14-R3	550-S14-Z	550-S14-Z2	550-S14-P	550-S14-PE	570-S14-Z8	570-S14-R3	570-S14-Z	570-S14-Z2	570-S14-P	570-S14-PE
Capacity	600 lbs	600 lbs	600 lbs	600 lbs	600 lbs	600 lbs	600 lbs	600 lbs	600 lbs	600 lbs	600 lbs	600 lbs
Wheel Type	Z8	R3	Z	Z2	P	PE	Z8	R3	Z	Z2	P	PE
Weight	24 lbs	21 lbs	29 lbs	27.5 lbs	24 lbs	22.5 lbs	24.5 lbs	21.5 lbs	29.5 lbs	28 lbs	24.5 lbs	23 lbs
S18" Nose Part #	220053	220052	220054	220256	220055	220271	220068	220067	220069	220259	220070	220274
Model #	550-S18-Z8	550-S18-R3	550-S18-Z	550-S18-Z2	550-S18-P	550-S18-PE	570-S18-Z8	570-S18-R3	570-S18-Z	570-S18-Z2	570-S18-P	570-S18-PE
Capacity	600 lbs	600 lbs	600 lbs	600 lbs	600 lbs	600 lbs	600 lbs	600 lbs	600 lbs	600 lbs	600 lbs	600 lbs
Wheel Type	Z8	R3	Z	Z2	P	PE	Z8	R3	Z	Z2	P	PE
Weight	26 lbs	23 lbs	31 lbs	29.5 lbs	26 lbs	24.5 lbs	26.5 lbs	23.5 lbs	31.5 lbs	30 lbs	26.5 lbs	25 lbs

Additional choices not listed above.

Z8	R3	Z	Z2	P	PE	BC-8	BC-10	Flat Free
Poly Offset 8" x 2"	Aluminum Offset 8" x 1.625"	Steel Offset 10" x 2.75"	Poly Offset 10" x 2.75"	Steel Offset 10" x 3.5"	Steel Offset 10" x 3.5"	Poly Hub 8" x 2.165"	Poly Hub 10" x 2.165"	Steel Offset 10" x 3"
Solid Rubber	Moldon Rubber	Semi-Pneumatic	Solid Rubber	Pneumatic	Pneumatic	Balloon Cushion	Balloon Cushion	Microcellular
150697	108561	150589	150698	050602	151505	150229	150228	053446



## Stair Glides

■ To order option, add Part # or Model # to truck.

**Example:**

Part # + Option #                      or                      Series + Nose + Wheel + Option = Model #  
22004 + 054211                      or                      500 + S14 + Z + S2F = 500-S14-Z-S2F

**FACTORY INSTALLED** Deluxe cast aluminum stair glides:

**FIELD INSTALLED** Deluxe cast aluminum stair glides:

■ Stair glides without wearstrips

■ Stair glides with wearstrips

■ Stair glide set without wearstrips

■ Stair glides with wearstrips

Part #                      054211  
Model #                      S2F

Part #                      054213  
Model #                      S3F

Part #                      220349  
Model #                      S2K

Part #                      220351  
Model #                      S3K

## Top Extensions



**FACTORY INSTALLED** Top Extensions for series 500, 510, 530, 540, 550, and 560 frames:

**FIELD INSTALLED** Top Extensions for series 500, 510, 530, 540, 550, and 560 frames:

■ 50" top extension    ■ 52" top extension    ■ 60" top extension    ■ 68" top extension

■ 50" top extension    ■ 52" top extension    ■ 60" top extension    ■ 68" top extension

Part #                      054232  
Model #                      50UF

Part #                      054206  
Model #                      52UF

Part #                      054207  
Model #                      60UF

Part #                      054209  
Model #                      68UF

Part #                      220098  
Model #                      50UK

Part #                      220080  
Model #                      52UK

Part #                      220081  
Model #                      60-UK

Part #                      220094  
Model #                      68UK

## Center Straps



Center strap option for series 500, 510, 520, 550, 570:

**FACTORY INSTALLED**

**KIT FOR FIELD INSTALLATION**

■ Single Strap

■ Double Strap

■ Single Strap

■ Double Strap

Part #                      054205  
Model #                      CSF

Part #                      054228  
Model #                      2CSF

Part #                      220085  
Model #                      CSK

Part #                      220088  
Model #                      2CSK

## Folding Nose



Folding nose available for all Mighty-Lite® trucks:

**FACTORY INSTALLED**

**KIT FOR FIELD INSTALLATION**

■ 20" Folding Nose

■ 30" Folding Nose

■ 20" Folding Nose

■ 30" Folding Nose

Part #                      054202  
Model #                      F2EF

Part #                      054203  
Model #                      F3EF

Part #                      220082  
Model #                      F2E

Part #                      220083  
Model #                      F3E

## Hanger Hooks



Hanger hook available for models 510, 540, 550, 560:

Factory Installed

Kit for Field Installation

Part #                      054204  
Model #                      HHF

Part #                      220084  
Model #                      HHK

Coca-Cola®, Pepsi-Cola®, Budweiser®, and Coors® stamped nose plates are available on all straight back Wesco Mighty-Lite hand trucks at no extra charge. Curved back frame models have stamped cross-braces instead of nose plates. Wesco can also custom emboss Mighty-Lites with your distributorship's or customer's name. Please call to obtain details on this inexpensive and long lasting form of advertising.



## 12" Deep Custom Nose Plate

12" deep x 16" wide nose plate kit for series 500, 510, 520, 550, and 570:

**5 year Guarantee Against Noseplate Breakage**

Part #                      054010  
Model #                      S26F

Part #                      220314  
Model #                      S26K

Factory Install

Field Install

## Cobra-Lite features:

- All aluminum construction.
  - Heavy duty cast 7.5" by 14" or 7.5" by 18" wide nose plate options.
  - Quality light weight truck at an economical price.
  - Ships KD and boxed or as components (see page 33).
  - Assembly option available.
  - All 2" wide cross braces for additional strength.
- Great for advertising label.



410-T14-R3

### Series 410

- Continuous handle.
  - 49" overall height.
  - Most popular model.
  - Available with vinyl dipped handle.
- See component system on page 33.

#### OVERALL DIMENSIONS

w: 18"  
h: 49"  
d: 20



420-T18-P

### Series 420

- High back pin handle.
- Comfortable vinyl hand grip.
- 52" overall height.

#### OVERALL DIMENSIONS

w: 18"  
h: 52"  
d: 20

T14" Nose Part #	220562	220332	220321	220370	220322	220375	220564	220333	220324	220371	220325	220376
Model #	410-T14-BC10	410-T14-R3	410-T14-Z	410-T14-Z2	410-T14-P	410-T14-PE	420-T14-BC10	420-T14-R3	420-T14-Z	420-T14-Z2	420-T14-P	420-T14-PE
Capacity	560 lbs	600 lbs	600 lbs	600 lbs	600 lbs	600 lbs	560 lbs	600 lbs	600 lbs	600 lbs	600 lbs	600 lbs
Wheel Type	BC-10	R3	Z	Z2	P	PE	BC-10	R3	Z	Z2	P	PE
Weight	25 lbs	19.5 lbs	27.5 lbs	26 lbs	22.5 lbs	21 lbs	25 lbs	19.5 lbs	27.5 lbs	26 lbs	22.5 lbs	21 lbs

T18" Nose Part #	220563	220392	220381	220396	220382	220365	220565	220393	220384	220397	220385	220366
Model #	410-T18-BC10	410-T18-R3	410-T18-Z	410-T18-Z2	410-T18-P	410-T18-PE	420-T18-BC10	420-T18-R3	420-T18-Z	420-T18-Z2	420-T18-P	420-T18-PE
Capacity	560 lbs	600 lbs	600 lbs	600 lbs	600 lbs	600 lbs	560 lbs	600 lbs	600 lbs	600 lbs	600 lbs	600 lbs
Wheel Type	BC-10	R3	Z	Z2	P	PE	BC-10	R3	Z	Z2	P	PE
Weight	26 lbs	20.5 lbs	28.5 lbs	27 lbs	23.5 lbs	22 lbs	26 lbs	20.5 lbs	28.5 lbs	27 lbs	23.5 lbs	22 lbs

Additional choices not listed above.

BC-10	R3	Z	Z2	P	PE	BC-8	Flat Free
Poly Offset Hub 10" x 2.165" Balloon Cushion	Aluminum Offset 8" x 1.625" Moldon Rubber	Steel Offset 10" x 2.75" Semi-Pneumatic	Poly Offset 10" x 2.75" Solid Rubber	Steel Offset 10" x 3.5" Pneumatic	Steel Offset 10" x 3.5" Pneumatic	Poly Hub 10" x 2.165" Balloon Cushion	Steel Offset 8" x 3" Microcellular
150228	108561	150589	150698	050602	151505	150229	053446

## Cobra-Lite features:

- All aluminum construction.
  - Heavy duty cast 7.5" by 14" or 7.5" by 18" wide nose plate options.
  - Quality light weight truck at an economical price.
  - Ships KD and boxed or as components (see page 33).
  - Assembly option available.
  - All 2" wide cross braces for additional strength.
- Great for advertising label.



450-T14-R3

### Series 450

- Twin handle style with vinyl grips.
- 49" overall height.

#### OVERALL DIMENSIONS

w: 18"  
h: 49"  
d: 20"



470-T14-BC10

### Series 470

- High back loop handle.
- 52" overall height.

#### OVERALL DIMENSIONS

w: 18"  
h: 52"  
d: 20"

T14" Nose Part #	220566	220334	220327	220372	220328	220377	220568	220335	220330	220373	220331	220378
Model #	450-T14-BC10	450-T14-R3	450-T14-Z	450-T14-Z2	450-T14-P	450-T14-PE	470-T14-BC10	470-T14-R3	470-T14-Z	470-T14-Z2	470-T14-P	470-T14-PE
Capacity	560 lbs	600 lbs	600 lbs	600 lbs	600 lbs	600 lbs	560 lbs	600 lbs	600 lbs	600 lbs	600 lbs	600 lbs
Wheel Type	BC-10	R3	Z	Z2	P	PE	BC-10	R3	Z	Z2	P	PE
Weight	25 lbs	20 lbs	28 lbs	26.5 lbs	23 lbs	21.5 lbs	25 lbs	20 lbs	28 lbs	26.5 lbs	23 lbs	21.5 lbs
T18" Nose Part #	220567	220394	220387	220398	220388	220367	220569	220395	220390	220399	220391	220368
Model #	450-T18-BC10	450-T18-R3	450-T18-Z	450-T18-Z2	450-T18-P	450-T18-PE	470-T18-BC10	470-T18-R3	470-T18-Z	470-T18-Z2	470-T18-P	470-T18-PE
Capacity	560 lbs	600 lbs	600 lbs	600 lbs	600 lbs	600 lbs	560 lbs	600 lbs	600 lbs	600 lbs	600 lbs	600 lbs
Wheel Type	BC-10	R3	Z	Z2	P	PE	BC-10	R3	Z	Z2	P	PE
Weight	26 lbs	21 lbs	29 lbs	27.5 lbs	24 lbs	22.5 lbs	26 lbs	21 lbs	29 lbs	27.5 lbs	24 lbs	22.5 lbs

Additional choices not listed above.

BC-10	R3	Z	Z2	P	PE	BC-8	Flat Free
Poly Offset Hub 10" x 2.165" Balloon Cushion	Aluminum Offset 8" x 1.625" Moldon Rubber	Steel Offset 10" x 2.75" Semi-Pneumatic	Poly Offset 10" x 2.75" Solid Rubber	Steel Offset 10" x 3.5" Pneumatic	Steel Offset 10" x 3.5" Pneumatic	Poly Hub 10" x 2.165" Balloon Cushion	Steel Offset 8" x 3" Microcellular
150228	108561	150589	150698	050602	151505	150229	053446





■ When ordering by part # add option part # to truck part #.

**Example:** 220320,220351

■ When ordering by model #, add option model # to truck model #.

**Example:** 410-T14-R2-S3K.



## Cobra-Lite Folding Nose for T-14 & T-18 Nose Plates



## Cobra-Lite Stairglide Options



Steel w/Wearstrip



Cast Aluminum

## Cobra-Lite Stairclimber Options

Stairclimbing Attachments

Deluxe Cast Aluminum Stairglides

Factory Installed

Kit for Field Installation

Factory Installed

Kit for Field Installation

■ 20" long ■ 30" long ■ 20" long ■ 30" long

■ Pair without wearstrips

■ Pair with wearstrips

■ Pair without wearstrips

■ Pair with wearstrips

■ Steel pair with wearstrips

■ Cast aluminum pair\*

■ Steel pair with wearstrips

■ Cast aluminum pair\*

Part #	054223	054225	220346	220343	054211	054213	220349	220351	054236	054237	220340	220339
Model #	F2F	F3F	F2K	F3K	S2F	S3F	S2K	S3K	S4F	S5F	S4K	S5K

\* With continuous rolling belt (8" wheel only)



## Top Extensions for 410 & 450 Models

(Vinyl coated top extensions available – see price list)

Factory Installed

Kit for Field Installation

■ 44" high

■ 52" high

■ 60" high

■ 68" high

■ 44" high

■ 52" high

■ 60" high

■ 68" high

Part #	050144	054206	054207	054209	220347	220080	220081	220094
Model #	44UF	52UF	60UF	68UF	44UK	52UK	60UK	68UK

## Handles    Frames    Noses



40R-Red 055143  
40B-Blue 050222  
Continuous handle  
with vinyl grip



45 - Twin handle  
w/brace 220119



41 - Continuous  
handle 151512



42 - Pin handle  
151511



47 - Loop handle  
151510 Can not be  
used with curved  
frame (5).



46 - Super D handle  
052512  
Fits curved frame



48 - Deep D handle  
052510 Fits Straight &  
Curved Frame



43 - 23.5" High D  
Handle Fits Straight  
Frame 151547



0  
Straight Frame  
153855



5  
Curved Frame  
153897

### Magnesium



M14 (cast)  
14" W x 7.5" D  
151523

### Aluminum



T14 (cast)  
14" W x 7.5" D  
151521

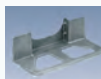

T18 (cast)  
18" W x 7.5" D  
151533



E14 (extruded)  
14" W x 7.625" D  
220287



E16 (extruded)  
16" W x 12" D  
220286



E18 (extruded)  
18" W x 7.625" D  
220285

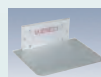

EC16 (extruded)  
Recessed Heel  
16" W x 12" D  
220506

For Curved Frame Only

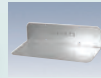

E918 (extruded)  
18" W x 9" D  
220461



Here's how to design your truck!  
Choose from these components...



**HANDLE, FRAME, NOSEPLATE**  
and **WHEEL** Then from the  
bottom of this page, choose  
your **OPTIONS**:



■ When ordering by model #, add option model # to truck model #.

**Example:**

41 + 0 + T18 + R3 + F3 + S4K = 410-T18-R3-F3-S4K

## Wheel Kits (axle/2 wheels/hardware)



P  
Steel Offset Hub  
10" x 3.5"  
Pneumatic Tire  
054045



PE  
Steel Offset Hub  
10" x 3.5"  
Pneumatic Tire  
054231



PWT  
Steel Offset Hub  
10" x 3.625"  
Pneumatic  
Wide Tread Tire  
220319



CF  
Steel Offset Hub  
10" x 3"  
Microcellular Polyurethane.  
Will not go flat  
220348



BC-8  
Poly Hub  
8" x 2.165"  
Balloon Cushion  
270275



BC-10  
Poly Hub  
10" x 2.165"  
Balloon Cushion  
270274



R2  
Poly Hub  
8" x 1.625"  
Moldon Rubber Tire  
054046



R3  
Aluminum Offset Hub  
8" x 1.625"  
Moldon Rubber Tire  
054048



Z8  
Poly Offset Hub  
8" x 2"  
Solid Rubber  
Tire  
220352



Z  
Steel Offset Hub  
10" x 2.75"  
Semi-Pneumatic  
Tire  
054047



Z2  
Poly Offset Hub  
10" x 2.75"  
Solid Rubber Tire  
054230

### Custom Side Strips



Promote your  
company and  
products with  
personalized side  
strips  
Ask your dealer  
for details.

### Stair Glide & Climber Options



S2K:  
\*Deluxe cast  
aluminum  
stair glides without  
wearstrip  
220349

S3K: with  
wearstrip  
220351



S4K  
Steel stair glides  
with wearstrips  
220340  
Field Install Kit

S4F #054236  
Factory Install



S5K  
Continuous belt  
stair climbers  
220339  
(For 8" wheel only)  
Field Install Kit

S5F #054237  
Factory Install

\*See price list for factory install options.

### Extension Options



Top extension for 40R, 40B,  
41 and 45 handles  
44UK - 44" top extension  
220347  
52UK - 52" top extension  
220080  
60UK - 60" top extension  
220081  
68UK - 68" top extension  
220094  
(Vinyl coated top extensions  
available - see price list)

### Options

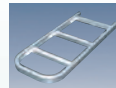

Folding nose extension  
20" long  
F2 - For Cast Noses  
220346  
F2E - For Extruded Noses  
220082  
30" long  
F3 - For Cast Noses  
220343  
F3E - For Extruded Noses  
220083

### Strap



CS  
Center strap  
option  
054062

# WESCO COBRA ALUMINUM CONVERTIBLE TRUCKS

## Cobra Jr. and Sr. features:

- 18" wide noseplate for large loads.
- Smooth and easy transition from the 2 to 4 wheeled position.
- Non-marking 5" x 1.25" swivel casters.

- 8 rivets per cross brace. Welded release pedal.
- Custom advertising side strips available – contact dealer for details.
- 2" wide cross braces for added strength and advertising labels.



## Higher Capacity Convertible Trucks - 1,200 lbs. 2 Year Frame Warranty



### Cobra Jr.

- 2 Year Frame Warranty.
- Dual hand grips for improved control.
- 3 frame cross braces.
- 12 inch x 38 inch frame bed.



CBR-JR-T18-PE

#### OVERALL DIMENSIONS

w: 22"  
h: 51.75"  
d: 19"



### Cobra Sr.

- 2 Year Frame Warranty.
- Continuous handle allows multiple ways to control load.
- 4 frame cross braces.
- 12 inch x 50.75 inch frame bed.



CBR-SR-T18-PE

#### OVERALL DIMENSIONS

w: 22"  
h: 61.75"  
d: 19"

T18 Nose Part #	220293*	220291*	220295*	220297*	220622*	220292*	220290*	220294*	220296*	220618*
Model #	CBR-JR-T18-PWT	CBR-JR-T18-PE	CBR-JR-T18-Z	CBR-JR-T18-Z2	CBR-JR-T18-CF	CBR-SR-T18-PWT	CBR-SR-T18-PE	CBR-SR-T18-Z	CBR-SR-T18-Z2	CBR-SR-T18-CF
E18 Nose Part #	220482*	220494*	220486*	220490*	220515*	220484*	220496*	220488*	220492*	220516*
Model #	CBR-JR-E18-PWT	CBR-JR-E18-PE	CBR-JR-E18-Z	CBR-JR-E18-Z2	CBR-JR-E18-CF	CBR-SR-E18-PWT	CBR-SR-E18-PE	CBR-SR-E18-Z	CBR-SR-E18-Z2	CBR-SR-E18-CF
Part #	220483*	220495*	220487*	220491*	220666	220485*	220497*	220489*	220493*	220667*
Model #	CBR-JR-E16-PWT	CBR-JR-E16-PE	CBR-JR-E16-Z	CBR-JR-E16-Z2	CBR-JR-E16-CF	CBR-SR-E16-PWT	CBR-SR-E16-PE	CBR-SR-E16-Z	CBR-SR-E16-Z2	CBR-SR-E16-CF
Capacity	600 lbs	600 lbs	600 lbs	600 lbs	560 lbs	600 lbs	600 lbs	600 lbs	600 lbs	560 lbs
2 Wheel	1,200 lbs	1,200 lbs	1,200 lbs	1,200 lbs	1,160 lbs	1,200 lbs	1,200 lbs	1,200 lbs	1,200 lbs	1,160 lbs
4 Wheel										
Frame Bed	12" x 38"	12" x 38"	12" x 38"	12" x 38"	12" x 38"	12" x 50.75"	12" x 50.75"	12" x 50.75"	12" x 50.75"	12" x 50.75"
Wheel	PWT	PE	Z	Z2	CF	PWT	PE	Z	Z2	CF
Weight	39 lbs	37.5 lbs	43.5 lbs	42.5 lbs	41 lbs	42.5 lbs	41 lbs	47 lbs	46 lbs	41 lbs

\*Add B to end of part number for blue coated handle option.

### Additional choices not listed above.

PWT (Wide Tread)	PE	Z	Z2	CF	BC-10
Steel Offset 10" x 3.5" Pneumatic	Steel Offset 10" x 3.5" Pneumatic	Steel Offset 10" x 2.75" Semi-Pneumatic	Poly Offset 10" x 2.75" Solid Rubber	Microcellular 10" x 3" Polyurethane	Poly Hub 10" x 2.165" Balloon Cushion
151507	151505	150589	150698	053446	150228

## Cobra Platform Deck Option

- Platform Deck: Slip resistant diamond pattern surface for both cast and extruded noseplates.



Part #	220288	220289	220318	220514
Model #	SRD	JRD	SRDE	JRDE
For Use With	Sr/Cast Noseplate	Jr/Cast Noseplate	Sr/Extruded Noseplate	Jr/Extruded Noseplate
Length	55"	42"	55"	42"
Weight	10 lbs	8 lbs	10 lbs	8 lbs

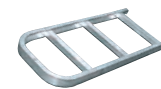

## Cobra Folding Nose Option

- Coated handle.
- Kit for Field Installation
  - 20" for T-18 Noseplates
  - 20" for E-18 & E-16 Noseplates
  - 30" for T-18 Noseplates
  - 30" for E-18 & E-16 Noseplates

Part #	220346	220082	220343	220083
Model #	F2	F2E	F3	F3E
Factory Installed				
Part #	054223	054202	054225	054203
Model #	F2F	F2EF	F3F	F3EF



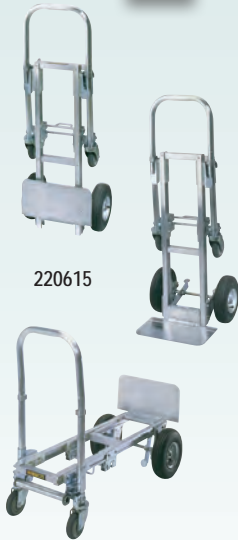

220615

## Mini Cobra

- 2 Year Frame Warranty.
- U.S Patent No. 6,234,497B1.
- Unique patented design allows user to fold nose for storage.
- Non-marking casters.
- 8.25 inch x 32.25 inch frame bed.

	2 Wheel	4 Wheel
OVERALL DIMENSIONS		
w:	15"	15"
h:	44"	29.5"
d:	16"	16"

## Spartan Jr.



220000

## Spartan Economy Aluminum 2 in 1 Trucks

- Value-priced truck.
- Sturdy, lightweight aluminum frame.
- 18" wide noseplate for large loads.
- Extra strength noseplate cast from special aluminum alloy.
- 10" full pneumatic or 10" solid rubber wheel.
- Non-marking 5" x 1.25" swivel casters.
- Pedal release allows easy conversion from 2-wheel to 4-wheel position.

	2 Wheel	4 Wheel
OVERALL DIMENSIONS		
w:	22"	22"
h:	52"	52"
d:	19"	19"

## Spartan Sr.



220001

PE	SR
Steel Offset 10" x 3.5" Pneumatic	Poly Offset 10" x 2.5" Solid Rubber
151505	108479

	2 Wheel	4 Wheel
OVERALL DIMENSIONS		
w:	22"	22"
h:	61.5"	61.5"
d:	19"	19"



270391

## Spartan III

- Value priced truck.
- Aluminum construction.
- 3 Positions:  
Vertical - 2 wheel  
45° - 4 wheel  
Platform - 4 wheel.
- 18" x 7.5" cast aluminum noseplate.
- 7.5" W x 27" L recessed folding nose extension.
- Handle height 48".
- 10" full pneumatic wheel.
- 5" x 1.25 swivel casters.
- Ships KD/boxed.

OVERALL DIMENSIONS
w: 21.5"
h: 52"
d: 19"

Part #	220615	220000	219998	220001	219999	270391
Model #	CBR-FBL	SPTN-JR-T18-PE	SPTN-JR-T18-SR	SPTN-SR-T18-PE	SPTN-SR-T18-SR	SPTN-III
Capacity						
2 Wheel	300 lbs	500 lbs	500 lbs	500 lbs	500 lbs	45° / 4 Wheel - 500 lbs
4 Wheel	500 lbs	1,000 lbs	1,000 lbs	1,000 lbs	1,000 lbs	2 Wheel - 500 lbs 4 Wheel - 750 lbs
Frame Bed	8.25" x 32.25"	12" x 38"	12" x 38"	12" x 51"	12" x 51"	12" X 51"
Wheel	8" Pneumatic	PE	SR	PE	SR	PE
Caster	4" Jarvis Advantage	5" x 1.25"	5" x 1.25"	5" x 1.25"	5" x 1.25"	5" x 1.25" Swivel Casters
Weight	28 lbs	37.5 lbs	50 lbs	41 lbs	53 lbs	42 lbs

## Spartan Options

- Platform Deck
- 30" Folding Nose

	Spartan Jr.	Spartan Sr.	Spartan Jr.	Spartan Sr.
Part #	220800	220288	220343	220343
Length	42"	55"	30"	30"
Weight	10 lbs	10 lbs	5 lbs	5 lbs

# WESCO® ALUMINUM 3 POSITION & POWERED CONVERTIBLE TRUCKS



**COBRA**



220594

## 3 Position Truck

- 2 Year Frame Warranty.
- Patent Number 6,364,328B1.
- Same strong, light-weight construction as the Cobra Jr.
- Quickly converts from 2-wheel to ergonomic tilt-back position or platform truck.
- 3 frame cross braces.
- T-18 nose.

### OVERALL DIMENSIONS

w: 21.5"  
h: 52"  
d: 19"



**BATTERY POWERED  
COBRAPRO**



CobraPRO Jr. and Sr. have 950 lb. capacity in 4-wheel mode and 600 lb. capacity in 2-wheel mode on standard 17.5° ramp.



220653



## CobraPRO Jr.

- 2 Year Frame Warranty.
- Dual hand grips for improved control.
- Variable speed fingertip control. Forward and reverse.
- 3 frame cross braces.

### OVERALL DIMENSIONS

w: 22"  
h: 51.75"  
d: 19"



220656 Shown with optional 30" folding nose #220343



## CobraPRO Sr.

- 2 Year Frame Warranty.
- Continuous handle allows multiple ways to control load.
- Variable speed fingertip control. Forward and reverse.
- 4 frame cross braces.

### OVERALL DIMENSIONS

w: 22"  
h: 61.75"  
d: 19"

Part #	220591	220593	220594	220653	220656
Model #	CBR-3-PE	CBR-3-PWT	CBR-3-Z	PCBR-JR-T18-PW2	PCBR-SR-T18-PW2
Capacity					
2 Wheel	500 lbs	500 lbs	500 lbs	600 lbs	600 lbs
4 Wheel	650 lbs	650 lbs	650 lbs	1,200 lbs	1,200 lbs
Frame Bed	12" x 38"	12" x 38"	12" x 38"	12" x 38"	12" x 50.75"
Wheel	PE	PWT	Z	10" Pneumatic	10" Pneumatic
Caster	5" x 1.25"	5" x 1.25"	5" x 1.25"	5" x 1.25"	5" x 1.25"
Weight	43 lbs	43 lbs	48 lbs	109 lbs	112.5 lbs

PE	PWT	Z
Steel Offset 10" x 3.5" Pneumatic	Steel Offset 10" x 3.625" Pneumatic	Steel Offset 10" x 2.75" Semi-Pneumatic
151505	151507	150589

## CobraPRO Options

- Platform Deck



CobraPRO Jr.

CobraPRO Sr.

- 30" Folding Nose



CobraPRO Jr.

CobraPRO Sr.

Part #	220289	220288	220343	220343
Model #	JRD	SRD	F3	F3
Weight	8 lbs	10 lbs	5 lbs	5 lbs

## Spare Battery Module

Part #220655

- Plugs directly into drive unit.
- No need to attach cables.
- Spare battery module includes 2 batteries and case.



**NEW!**  
725 lb. High Capacity Model

274101

## Power LiftKar HD

### Two Models

- **Uni** – straight frame – accepts dolly option for 4-wheel support.
- **Fold** – upper handle angle can be adjusted. Best for copiers, safes, heavy motors or any short and heavy load which would require the user to pull the load back to a very low position. The adjustable angle position on the Fold model allows the user to stand upright when using the truck at a very low angle.
- Innovative edge-of-step braking system – automatically applies brake when wheels are at edge of step. Helps prevent loss of load control caused by accidental rolling down steps.
- Brake can be shut off for use on level ground – prevents unwanted braking when moving over ground with an uneven surface.
- Two operating modes: single step (ascend or descend button must be pressed after each step – ideal for maximum control), or continuous climb.
- 24v quick-change battery pack – sealed maintenance-free battery.
- Two climbing speeds: 6 steps/min. or 10 steps/min.
- Average number of steps with fully charged battery:  
440 lbs. of cargo - 220 steps  
550 lbs. of cargo - 190 steps  
725 lbs. of cargo - 120 steps.

### Power LiftKar Options

- **Part # 274103 - Snap-on toe plate** equipped with 4 dual casters. Provides additional cargo space and the ability to move loads without tilting truck. Especially useful in confined areas.
- **Part # 274102 - Fold-out rear wheel carriage** (Universal model only) slides easily into position to provide 4-wheel support.
- **Part # 274116 - Extra battery pack.**

Part #274100 with optional snap-on toe plate - #274103.



Part #274100 with optional fold-out wheel carriage - #274102.



### OVERALL DIMENSIONS

w:	21"	21"
h:	63"	47" - folded
d:	19"	19"



230051



DC-66

## StairKing Battery Powered Stair Climbing Appliance Truck

- **U.S. Pat. No. 7,137,464**
- Welded aluminum construction.
- 1/2 Horsepower, 50 amp, high torque motor runs cooler under load.
- Industrial grade gear box transmits steady power and is preferable to other drive designs.
- Large 2" diameter, polyurethane lifting feet provide more secure stair gripping.
- Auto rewind ratchet works first to take the slack out of the cargo belt, and then provides a ratchet crank to securely tighten the load.
- Noseplate measures 24" by 4" deep. Welded light-weight frame and noseplate.
- Sealed maintenance-free battery. Charger and circuit breaker included.
- 6" moldon rubber wheels.
- **DB: Dual battery models for longer life between charges. Part # DBDC-66 or DBDC-72.**
- Average number of steps with fully charged battery/batteries:

	DC Single Battery	DB Dual Battery
225 lbs	160	325
450 lbs	135	280
850 lbs	70	145

OVERALL DIMENSIONS

w:	24"
h:	66" or 72"
d:	12"

### NEW DUAL BATTERY MODELS!

See page 38 for StairKing Options.



HAND TRUCKS

Part #	274100	274101	230051	230251	230052	230252
Model	Universal	Fold	DC-66	DBDC-66	DC-72	DBDC-72
Battery	Single	Single	Single	Dual	Single	Dual
Capacity	725 lbs	725 lbs	850 lbs	850 lbs	850 lbs	850 lbs
Ratchet	N/A	N/A	Auto rewind	Auto rewind	Auto rewind	Auto rewind
Belt	2 piece with clasp - 10'	2 piece with clasp - 10'	2 piece w/clasp	2 piece w/clasp	2 piece w/clasp	2 piece w/clasp
Height	63" straight frame	47" folded	66" tall frame	66" tall frame	72" tall frame	72" tall frame
Weight	262 lbs	251 lbs	101 lbs	111 lbs	102 lbs	112 lbs



DC-66  
with  
WLF Option



WLF  
Winch Lift  
Option

- Optional aluminum winch lift attachment has 800 lb capacity.
- 3-1/2" Jarvis Advantage® swivel casters for 4 wheel support and mobility.
- Winch equipped with autobraking system.
- 18" forks, adjustable width up to 19" outside dimension.
- 57.25" lift height.
- Factory or field installation.

**OVERALL DIMENSIONS**

w: 25"  
h: 70"  
d: 30"

## StairKing Battery Powered Stair Climbing Appliance Truck

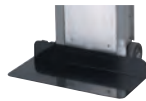
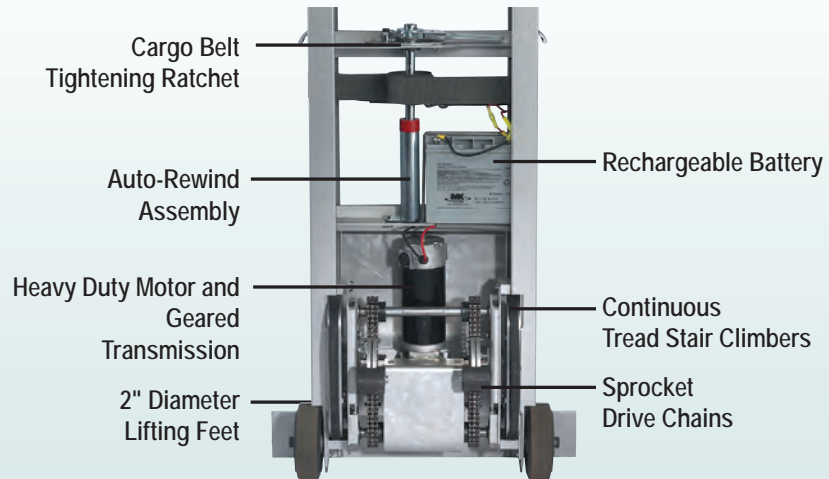

NE-28  
Steel Nose  
Extension  
Option

- Toe plate extension. Easily clips on to standard toe plate and provides 12" deep x 28" wide cargo surface.

**OVERALL DIMENSIONS**

w: 28"  
h: 4"  
d: 12"



SP-20  
Platform  
Option  
slips onto  
WLF forks

- Platform attachment. Slides in place over winch lift forks to provide a 20" x 20" lifting platform.

**OVERALL DIMENSIONS**

w: 20"  
h: 7"  
d: 20"



MSWK  
Superwheel  
Option

- Superwheel attachment installs in seconds.
- Equipped with 10" x 4" full pneumatic tires. Provides 4 wheel support and eases transport over rough surfaces.

**OVERALL DIMENSIONS**

w: 11.5"  
h: 4.5"  
d: 20.5"



KOW  
Kick-out Wheel

- Kick-Out 3.5" casters for four wheel stability.



Battery  
Charger  
Cord

- Charge battery while driving between stops.
- Plugs into cigarette lighter.
- Cable length 20'.
- Charger is included with truck purchase.

Part #	230053	230055	260160	270076	230059	230060
Model #	WLF	NE-28	SP-20	MSWK	KOW	BC
Capacity	800 lbs	850 lbs	800 lbs	N/A	850 lbs	N/A
Description	Aluminum winch lift attachment*	Steel Nose Extension	Steel Slip on Platform	Superwheel Option	Kick-out Wheel	Cigarette Lighter Charger
Weight	67 lbs	18 lbs	20 lbs	19 lbs	9 lbs	2 lbs



## Features:

- **Welded frame and handles for maximum strength.**
- **Non-marking grey vinyl on all contact surfaces securely mounted to truck.**
- **2" wide heavy duty web belt.**



Improved kick-out design allows operator to kick-out wheels with both hands on the truck.



WRCV-66



WRC

**LOOK.**  
NOW AVAILABLE with 8" x 2" solid rubber wheels - WRC-Z8

## Wesco Steel Vending Machine Trucks

- Retractable moldon rubber casters (3.5" diameter) help support load.
- Heavy duty 8" cast iron center moldon rubber wheels with roller bearings - #150120.
- Available with "Auto-Rewind" or "Manual" belt tightening systems.
- 28.5" from noseplate to center of belt.
- 60" and 66" frame - 3/4"-14 Ga. steel tube.
- 72" frame - 1"-14 Ga. steel tube.

### OVERALL DIMENSIONS

w: 24"  
h: 60" or 66" or 72"  
d: 14.5"

## Wesco Steel Appliance Trucks

- All joints double welded for maximum durability.
- Rugged tubular steel construction.
- Available with "Auto-Rewind" or "Manual" belt tightening systems.
- Available with 6" x 2", 8" x 1.625" and 8" x 2" wheels with 5/8" precision ball bearings.
- 26.5" from noseplate to center of belt.

### OVERALL DIMENSIONS

w: 24"  
h: 59"  
d: 10"



Part #	230035	230017	230036	230018	230037	230019	230010	230011	230012	230028	230029
Model #	WRV-60-EC	WRV-60	WRV-66-EC	WRV-66	WRV-72-EC	WRV-72	WRC	WRC-R	WRC-Z8	WRC-EC	WRC-R-EC
Capacity	1,200 lbs	1,200 lbs	1,200 lbs	1,200 lbs	1,200 lbs	1,200 lbs	750 lbs	750 lbs	600 lbs	750 lbs	750 lbs
Ratchet	Manual	Auto rewind	Manual	Auto rewind	Manual	Auto rewind	Auto rewind	Auto rewind	Auto rewind	Manual	Manual
Belt	1 piece	2 piece clasp	1 piece	2 piece clasp	1 piece	2 piece clasp	2 piece clasp	2 piece clasp	2 piece clasp	1 piece	1 piece
Wheel	HB	HB	HB	HB	HB	HB	A	R	Z-8	A	R
Height	60"	60"	66"	66"	72"	72"	59"	59"	59"	59"	59"
Weight	83 lbs	83 lbs	86 lbs	86 lbs	95 lbs	95 lbs	52 lbs	53 lbs	50 lbs	52 lbs	53 lbs



## Super Wheel

Part #270075 Model # SSWK

- 10" pneumatic rear wheels.
- Quick and easy turnbuckle mounting system.
- Converts a 2 wheel truck into a 4 wheel truck.

Note: Cannot be used on 72" WRV-72 Models.

A	R	Z8	HB
Aluminum 6" x 2" Moldon Rubber	Aluminum 8" x 1.625" Moldon Rubber	Poly Hub 8" x 2" Solid Rubber	Cast Iron Hub 8" x 2" Moldon Rubber
050567	108545	150697	150120





230020

## Wesco Steel Vending Truck

- Dual handle control.
- Large pneumatic wheels for rough terrain - #108484.
- Welded steel frame.
- One piece belt.
- 47" from noseplate to center of belt.
- 55" height.

### OVERALL DIMENSIONS

w: 28.5"  
h: 55"  
d: 20"



230072

230074

## Heavy Duty Vending Trucks

- **WHEEL LOCK FEATURE STANDARD:** Front wheels have wheel locks to allow truck to be placed in upright position without the danger of the truck rolling away from operator. Wheel lock is activated by a conveniently located lever at top of truck.
- In transport position load rests on (2) 10" aluminum or poly hub moldon rubber wheels and (2) 5" poly hub moldon rubber front wheels.
- Rear main wheel design allows truck to be tilted back to clear doorways. Especially useful with tall vending machines or other tall cargo.
- Available in 72" and 78" heights.
- 2 webbed cargo belts with eccentric tighteners for maximum load security.
- Constructed of heavy duty 1" diameter steel tubing.
- Noseplate - 9" x 24" x 1/4" thick.

### OVERALL DIMENSIONS

w:	24"	24"	24"	24"	27"	27"
h:	72"	72"	78"	78"	72"	78"
d:	22"	22"	22"	22"	18"	18"



230076

A Wesco Unique Design - Swivel Casters for Easy Mobility

## Heavy Duty Auto-Rewind Appliance Truck with Swivel Casters

- **WHEEL LOCK FEATURE STANDARD**
- Dynamic fulcrum system – fulcrum point changes as truck is tilted to decrease break-over effort.
- Conveniently located lever releases rear carriage and activates dynamic fulcrum system.
- 10" poly hub main wheels, 6" rear swivel casters.
- Folding rear carriage allows truck to be used in 2-wheel or 4-wheel mode.
- Available in 72" and 78" heights.
- 2 webbed cargo belts with ratchet tighteners for maximum load security.
- Constructed of heavy duty 1" diameter steel tubing.
- Noseplate - 5" x 24" x 1/4".

### OVERALL DIMENSIONS

w:	27"	27"
h:	72"	78"
d:	18"	18"

Part #	230020	230070	230071	230072	230073	230074	230075	230076	230077
Model #	L-1	HDVT-72-EC	HDVT-72	HDVT-78-EC	HDVT-78	HDSV-72	HDSV-78	WRV-MAX-72	WRV-MAX-78
Capacity	700 lbs	1,800 lbs	1,800 lbs	1,800 lbs	1,800 lbs	1,800 lbs	1,800 lbs	1,800 lbs	1,800 lbs
Ratchet	N/A	Eccentric	Auto Rewind	Eccentric	Auto Rewind	Auto Rewind	Auto Rewind	Auto rewind	Auto rewind
Belt	1 piece clasp	1 piece	2 piece w/clasp	1 piece	2 piece w/clasp	2 piece w/clasp	2 piece w/clasp	2 piece w/clasp	2 piece w/clasp
Wheel	P-12	10" x 2.5" Alum.	10" x 2.5" Alum.	10" x 2.5" Alum.	10" x 2.5" Alum.	10" x 2" Poly	10" x 2" Poly	10" x 2" Poly	10" x 2" Poly
Weight	62 lbs	137 lbs	137 lbs	142 lbs	142 lbs	126 lbs	129 lbs	120 lbs	130 lbs

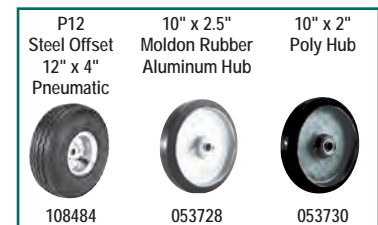



## Wesco Aluminum Appliance Trucks

- Fully welded frame and handles for maximum strength and durability.
- Available with "Auto-Rewind", or "Manual" belt tightening systems.
- MRC Trucks, 30.5" from noseplate to center of belt.
- M2RC Trucks, from noseplate to center of lower belt 29.5" and 50.5" to center of top belt.



### OVERALL DIMENSIONS

w:	24"	24"	24"	24"	24"	24"	24"	24"	24"	24"
h:	59"	59"	59"	59"	59"	59"	59"	59"	66"	66"
d:	11"	13"	15"	15"	11"	13"	15"	15"	11"	13"

Part #	230001	230002	230004	230005	230030	230031	230032	230033	230008	230009
Model #	MRC	MRC-R	MRC-Z	MRC-PWT	MRC-EC	MRC-EC-R	MRC-EC-Z	MRC-EC-PWT	M2RC-66-EC	M2RC-66-EC-R
Capacity	750 lbs	750 lbs	500 lbs	600 lbs	750 lbs	750 lbs	500 lbs	600 lbs	750 lbs	750 lbs
Ratchet	Auto rewind	Auto rewind	Auto rewind	Auto rewind	Manual	Manual	Manual	Manual	(2) Manual	(2) Manual
Belt	2 piece w/ clasp	2 piece w/ clasp	2 piece w/ clasp	2 piece w/ clasp	1 piece	1 piece	1 piece	1 piece	(2) 1 piece	(2) 1 piece
Wheel	A	R	Z	PWT	A	R	Z	PWT	A	R
Weight	41 lbs	50 lbs	58 lbs	53 lbs	39 lbs	50 lbs	56 lbs	53 lbs	45 lbs	55 lbs

## Wesco Aluminum Vending Machine Trucks

- Foot pedal release for casters allow operator to open and close them while standing upright.
- Retractable moldon rubber casters (3.5" diameter) help support load.
- Continuous belt stairclimbers are standard.
- 29" from noseplate to center of belt.



MRV-66-EC

MRV-66-EC  
Welded Aluminum Frame  
A Wesco Exclusive

5" deep aluminum nose plate

.625" ball bearing wheels



Improved kick-out design allows operator to kick-out wheels with both hands on the truck.

### OVERALL DIMENSIONS

w:	24"
h:	60"
d:	11"

## Economical Aluminum Appliance and Vending Trucks

- **Wesco USA Made ratchets.**
- Lightweight aluminum frame with auto rewind ratchet.
- Model AAP-612 has double ratchet design for greater cargo security.
- Model AVT-61 has four wheel kick-out design to support heavy loads and help reduce the strain of balancing the cargo over long distances.
- 6" x 2" moldon rubber wheel.



AVT-61



AAP-61



AAP-612

### OVERALL DIMENSIONS

w:	24"	24"	24"
h:	61"	61"	61"
d:	12"	12"	12"

Part #	230038	230040	272410	272411	272412
Model #	MRV-60-EC	MRV-66-EC	AAP-61	AAP-612	AVT-61
Capacity	750 lbs	750 lbs	550 lbs	550 lbs	550 lbs
Ratchet	Manual	Manual	Auto rewind	Auto rewind	Auto rewind
Belt	one piece	one piece	2 piece w/clasp	double 2 piece w/clasp	2 piece w/clasp
Wheel	A	A	6" x 2"	6" x 2"	6" x 2" (2" x 1" caster)
Weight	61 lbs	63 lbs	41 lbs	43 lbs	49.75 lbs

## Super Wheel Options

(for aluminum MRC Model appliance trucks only)

Part #270076 Model # MSWK

- 10" pneumatic rear wheels for easy handling on rough terrain.
- Quick and easy turnbuckle mounting system.
- Converts a 2 wheel truck into a 4 wheel truck.



A	R	Z	PWT
Aluminum 6" x 2"	Aluminum 8" x 1.625"	Steel Offset 10" x 2.75"	Steel Offset 10" x 3.625"
Moldon Rubber	Moldon Rubber	Semi-Pneumatic	Pneumatic
050567	108545	150589	151507