



WARNER™
TOOL

Putting Quality and Innovation in Your Hands™



A Category Leader Since 1927

For more than 70 years, contractors, homeowners and retailers have learned to depend on tools that carry the Warner brand. We've earned that trust by keeping our focus on tools that will help customers do a better job in construction and remodeling. We continuously strive to find innovative ways to provide the added value you have come to expect from Warner. In short, we are committed to developing new products and programs for tomorrow, today.

To our retail customers, we thank you for your support. Our pledge to continually improve customer service has not wavered. With our rapid response system, we have been able to deliver 99% of our orders on time and complete. Our goal, however, remains 100%. We're proud of the quality we offer and hope you see us not just as a supplier, but as a category leader.

For the professional men and women who earn their pay in the construction trades, thank you for putting your trust in the Warner brand. It is, after all, the quality of your work which makes each of us in this industry proud. Though our tools are only a part of what helps you with your day-to-day tasks, you can always be assured we are the brand you can trust.

For the homeowner that likes to do it yourself, you can select the same quality tools as the professional or our value-priced tools that are designed for the Do-It-Yourselfer.

We take pride in all the products we produce for our customers and are committed to continuously improving Warner value, service and innovation.



Jerry Ranallo
President



Guy R. Warner
Chairman of the Board

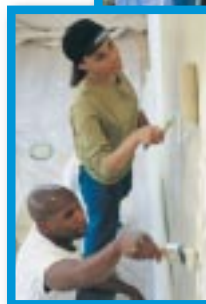

PUTTY KNIVES AND SCRAPERS

ProGrip2™ Series	4–7
600 Series	8–9
ProCut™ Series	10
180 Series	10
900 Series, Retractable, Patcher, Tang-Driven	11

PAINT SCRAPERS

Carbide 100X™ Paint Scrapers	12
2- and 4-Edge Paint Scrapers	13
Molding Scraper	14
Pivot Head Scraper	14
Paint Remover, Electric	14
Burn-Off Scrapers	15
ProGrip® Brass Blade Scrapers	15
Painter's Prep Kit	15
Furniture Refinishing Tool	15
Floor Scrapers, Heavy-Duty	16
Big Blade Wall Scrapers	17
Glass Scrapers	18

KNIVES

Razor, Utility and 3½" Blades	19
Folding Knives	20
Hawkbill Knives	20
Razor Knives	21
Snap-Off Blade Knives	21
Utility Knives	22
Utility Blades	22

PAINTING ACCESSORIES

Brush and Roller Cleaners	23
Drop Cloths	23
Pot Hooks	23
Knee Pads	23
Specialty Tools	24
Paint Edgers	24
Door Stand	24
Spray Shields	25
Trim Guides	25
Pry Bars	26
Sanders	26
Buckets	27
Bucket Openers	27
Mixers	28

WINDOW TOOLS

Glass Cutters and Window Tools	29
--------------------------------------	----

EXTENSION POLES AND ACCESSORIES

Fiberglass/Aluminum/Button Lock	30
Metal Poles, Twist Lock, Fixed	30
Extension Pole Accessories	31

TAPING KNIVES

Blue Steel	32–33
Stainless Steel	32–33
ProGrip	33
Offset	33

DRYWALL TOOLS

Trowels, Floats, Smoothers	34
Mud Pans, Hawk	35
Hand and Pole Sanders	36
Saws, T-Squares	37
Drywall Kit	38
Circle Cutters, Crimper, Lifters	38
Mixers	38

STILTS AND BENCH

TILE TOOLS

Trowels	40
Adhesive Spreaders	40
Spacers	40
Cutters, Saws, Nippers	41
Grout Spreader, Sponge	41

MASONRY TOOLS

Finishing Trowels, Pointing Trowels	42
Floats	43
Groover and Jointing Trowels	43

BRUSHES

Mini Brushes	44
Wire Brushes	44
Applicator Brushes	44

WALLCOVERING TOOLS

Smoothers, Brushes, Shears	45
Seam Rollers	46
Cutter, Kits	47
Accessories	48
Wallwik®	49

MEASURING TOOLS

Levels, Rulers, Tapes, T-Squares	50
--	----

POINT-OF-SALE

Clip Strips	51
Bucket Display Assortment	56

PRODUCT ASSORTMENTS

RENTAL PRODUCTS

PRODUCT INDEX PAGES

Another Innovative Tool for the Professional

Professional contractors told us the two most important features in selecting a putty knife or scraper were blade flexibility and a comfortable handle. The ProGrip²™ Series was developed to deliver professional quality and performance on both counts.

The ProGrip² Flexibility System uses color-coded handles to identify Stiff, Flex, Full Flex and Flex Rated tools. Customers will be able to select the right flex every time. Scraping tools feature handles with a ribbed finger grip and are curved to fit the palm for better pushing control.

- Soft grip handle
- High-quality carbon steel blades
- Full tang for maximum strength
- Blades secured to handle
- Guaranteed for life
- Patents pending
- Made in U.S.A.

Red Handle Insert

Heavy-duty blades provide maximum strength and have a chisel edge ground at a 16° angle. It is the optimum angle for fine scraping and shaving with less gouging or chipping. The 5-in-1, 6-in-1 and 8-in-1 Glazier Knives will also squeegee paint rollers. Standard blades are .060" thick and heavy-duty blades are .080" thick.

STANDARD HANDLE

Item No.	Description
90101 PRO	1¼" Chisel Putty Knife, .080", Stiff
90107 PRO	1¼" Putty Knife, Stiff
90109 PRO	1½" Putty Knife, Stiff
90111 PRO	2" Putty Knife, Stiff
90115 PRO	3" Scraper, Stiff
90119 PRO	4" Broad Knife, Stiff
90129 PRO	6" Broad Knife, Stiff
90189 PRO	5-in-1 Glazier Knife, .080", Stiff Scraper, Roller Squeegee, Spreader, Crack Cleaner, Can Opener

STANDARD HANDLE—STEEL HEAD

Item No.	Description
90100 PRO	1¼" Chisel Putty Knife, Steel Head, .080", Stiff
90171 PRO	2" Putty Knife, Steel Head, Stiff
90175 PRO	3" Scraper, Steel Head, Stiff
90199 PRO	6-in-1 Glazier Knife, Steel Head, .080", Stiff Scraper, Roller Squeegee, Spreader, Crack Cleaner, Can Opener, Nail Setter
90173 PRO	8-in-1 Glazier Knife, Steel Head, Stiff Scraper, Roller Squeegee, Spreader, Crack Cleaner, Can Opener, Utility Knife, Nail Setter, Nail Puller



#90101
1¼" Chisel Putty Knife
Stiff



#90115
3" Scraper
Stiff



#90175
3" Scraper
Steel Head, Stiff



#90173
8-in-1 Glazier Knife
Steel Head, Stiff



#90189
5-in-1 Glazier Knife
Stiff

Blue Handle Insert

Standard carbon steel blades are hollow ground to provide consistent flex and proper stiffness for spreading heavy drywall compound. Ideal for first-coat applications. Ergonomic handles are designed to fit the hand more comfortably, for use as a spreading tool and to reduce fatigue.

- Soft grip handle
- High-quality carbon steel blades
- Full tang for maximum strength
- Blades secured to handle
- Extra large Hammer Cap™ models
- Guaranteed for life
- Patents pending
- Made in U.S.A.

STANDARD HANDLE

Item No.	Description
90106 PRO	1¼" Putty Knife, Flex
90108 PRO	1½" Putty Knife, Flex
90110 PRO	2" Putty Knife, Flex
90114 PRO	3" Putty Knife, Flex
90118 PRO	4" Broad Knife, Flex
90120 PRO	5" Broad Knife, Flex
90122 PRO	6" Broad Knife, Flex



#90108
1½" Putty Knife
Flex



#90114
3" Putty Knife
Flex



#90124
4" Broad Knife
Steel Head, Flex

STANDARD HANDLE—STEEL HEAD

Item No.	Description
90123 PRO	3" Putty Knife, Steel Head, Flex
90124 PRO	4" Broad Knife, Steel Head, Flex
90125 PRO	5" Broad Knife, Steel Head, Flex
90126 PRO	6" Broad Knife, Steel Head, Flex



#90178
6" Broad Knife
XL, Steel Head, Flex

XL HANDLE—STEEL HEAD

Item No.	Description
90172 PRO	2" Putty Knife, XL, Steel Head, Flex
90174 PRO	3" Putty Knife, XL, Steel Head, Flex
90176 PRO	4" Broad Knife, XL, Steel Head, Flex
90177 PRO	5" Broad Knife, XL, Steel Head, Flex
90178 PRO	6" Broad Knife, XL, Steel Head, Flex

Yellow Handle Insert

Full Flex applies to blades that have been hollow ground thinner for maximum flexibility. They are designed for lighter compounds and higher application rates. Perfect choice for final- or finish-coat applications.

Ergonomic handle is wider and flatter, designed to fit the hand for use as a spreading tool and to reduce fatigue. Design improves blade control.

- Soft grip handle
- High-quality carbon steel blades
- Full tang for maximum strength
- Blades secured to handle
- Guaranteed for life
- Patents pending
- Made in U.S.A.

STANDARD HANDLE

Item No.	Description
90131	PRO 1¼" Putty Knife, Full Flex
90127	PRO 1½" Putty Knife, Full Flex
90128	PRO 2" Putty Knife, Full Flex
90133	PRO 3" Putty Knife, Full Flex
90135	PRO 4" Broad Knife, Full Flex
90136	PRO 5" Broad Knife, Full Flex
90137	PRO 6" Broad Knife, Full Flex



#90127
1½" Putty Knife
Full Flex



#90133
3" Putty Knife
Full Flex



#90137
6" Broad Knife
Full Flex



FULL FLEX

ProGrip ²		1¼"	1½"	2"	3"	4"	5"	6"	Glazier
For Scraping and Removal	Stiff	90101 90107 90100	90109	90111 90171	90115 90175	90119		90129	90189 90173 90199
First-Coat Applications	Flexible	90106	90108	90110 90172	90114 90123 90174	90118 90124 90176	90120 90125 90177	90122 90126 90178	
Finish-Coat Applications	Full Flex	90131	90127	90128	90133	90135	90136	90137	
#4 Flex Rated	Full Flex								90180
#3 Flex Rated	Medium Flex								90182
#2 Flex Rated	Firm Flex								90184
#1 Flex Rated	Rigid Flex								90186

Use 1¼"-1½" knives to apply spackle, putty and for detail work in small areas.

Use 2"-3" knives for patching, touch-up and heavy-duty scraping.

Use 4"-6" knives for taping drywall joints and large surface filling.

Use Glazier Knife as a multi-purpose tool to scrape, spread, clean and glaze.

ProGrip², Hammer Cap™ color coding and icons are trademarks of Warner Manufacturing. Patents pending.

Orange Handle Insert

Have you ever watched a contractor go through a rack of knives testing the blade flex? Professionals often test knife after knife looking for that special feel. That's why Warner has introduced Flex Rated Broad Knives. It's an industry first, four standardized flexes, so the contractor can buy the same feel every time. Guaranteed.

Blades on these ProGrip2™ tools are hollow ground to be progressively more flexible, from #1 to #4. Blades are selected to meet the exact specifications of each flex level, so customers get the same flex every time.

Ergonomic handles are wider, flatter and extra large. The larger size enhances both control and comfort. XL size also fits larger hands and reduces fatigue.

- Guaranteed flex ratings
- Soft grip XL handle
- High-quality carbon steel blades
- Full tang for maximum strength
- Blades secured to handle
- Extra large Hammer Cap™ models
- Guaranteed for life
- Patents pending
- Made in U.S.A.

XL HANDLE—FLEX RATED

Item No.	Description
90180 PRO	6" Broad Knife, XL, Steel Head, Flex Rated #4 (Full Flex)
90182 PRO	6" Broad Knife, XL, Steel Head, Flex Rated #3 (Medium Flex)
90184 PRO	6" Broad Knife, XL, Steel Head, Flex Rated #2 (Firm Flex)
90186 PRO	6" Broad Knife, XL, Steel Head, Flex Rated #1 (Rigid Flex)



#90180, #90182,
#90184, #90186
6" Broad Knife, XL,
Steel Head, Flex Rated



#10199
ProGrip2
6-in-1 Display



PROGRIP2 ASSORTMENTS

Item No.	Description
91066 PRO	ProGrip2 Standard Handle Assortment (See Page 52)
91093 PRO	ProGrip2 XL Handle Assortment (See Page 52)
10199 PRO	ProGrip2 6-in-1 Counter Display Box
10173 PRO	ProGrip2 8-in-1 Counter Display Box

#10173
ProGrip2
8-in-1 Display



600 Series Putty Knives and Scrapers

Warner Quality— Craftsmanship You Can Trust

If you're a professional who likes the feel of wood-handled tools but wants the performance of today's technology, the choice is Warner. The 600 Series offers the same high-quality blades as the ProGrip® Series, but with hardwood handles. Rosewood-colored handles are laminated and then pressure treated with resin to be moisture resistant. Won't swell or crack. Blades are made from .050", .060" and .080" thick carbon steel.

600 Series Features:

- Blades are made of #1074 high carbon-grade steel
- Hollow-ground, heat-treated and annealed for toughness
- Blades polished and buffed to high luster finish for easier application and cleanup
- Full-tang design for maximum strength
- Brass rivets and eyelets mechanically lock handle to tang so it can't come loose



#379
5-in-1 Glazier Knife
Stiff



#615
3" Scraper
Stiff

STIFF

Heavy-duty blades provide maximum strength and have a chisel edge ground at a 16° angle. It is the optimum angle for fine scraping and shaving with less gouging or chipping.



STIFF

Item

No.	Description
603 PRO	¾" Putty Knife, Chisel Ground, Stiff
601 PRO	1¼" Putty Knife, Chisel Ground, .080" Stiff
607 PRO	1¼" Putty Knife, Stiff
609 PRO	1½" Putty Knife, Stiff
611 PRO	2" Putty Knife, Stiff
615 PRO	3" Scraper, Stiff
379 PRO	5-in-1 Glazier Knife, .080" Stiff



#618
4" Broad Knife
Flex



FLEX

FLEX

Carbon steel blades of .050" and .060" thickness are hollow ground to provide a flex with the proper stiffness to handle heavy drywall compounds. Use these for first-coat applications.

Item

No.	Description
606 PRO	1¼" Putty Knife, Flex
608 PRO	1½" Putty Knife, Flex
610 PRO	2" Putty Knife, Flex
614 PRO	3" Putty Knife, Flex
618 PRO	4" Broad Knife, Flex
620 PRO	5" Broad Knife, Flex
622 PRO	6" Broad Knife, Flex

FULL FLEX

Full Flex applies to blades that have been hollow ground thinner for maximum flexibility. They are designed for lighter compounds and higher application rates. Ideal for finish- or final-coat applications.



FULL FLEX

Item

No.	Description
604 PRO	3/4" Putty Knife, Full Flex
621 PRO	1 1/4" Putty Knife, Full Flex
627 PRO	1 1/2" Putty Knife, Full Flex
628 PRO	2" Putty Knife, Full Flex
633 PRO	3" Putty Knife, Full Flex
635 PRO	4" Broad Knife, Full Flex
636 PRO	5" Broad Knife, Full Flex
637 PRO	6" Broad Knife, Full Flex
1076 PRO	600 Series Assortment Includes 5 Each of Best Sellers (See Page 53)



#604
3/4" Putty Knife
Full Flex



#627
1 1/2" Putty Knife
Full Flex



#637
6" Broad Knife
Full Flex



#635
4" Broad Knife
Full Flex

		3/4"	1 1/4"	1 1/2"	2"	3"	4"	5"	6"	Glazier
For Scraping and Removal	Stiff	603	601 607	609	611	615				379
For Spreading and Applying	Flex		606	608	610	614	618	620	622	
Applying Lightweight Materials	Full Flex	604	621	627	628	633	635	636	637	

Use 3/4"-1 1/2" knives to apply spackle, putty and for detail work in small areas.

Use 2"-3" knives for patching, touch-up and heavy-duty scraping.

Use 4"-6" knives for taping drywall joints and large surface filling.

Use 5-in-1 Glazier Knife as a multi-purpose tool to scrape, spread, clean and glaze.

Icons are trademarks of Warner Manufacturing.

ProCut™ and 180 Series Putty Knives and Scrapers

ProCut

Ground and polished high-carbon steel blades are matched to molded handles creating exceptional tool values. Blades are .050" and .035" thick and are hollow ground to put the correct amount of blade and pressure on the work surface.

Handle is an ergonomic design molded of polypropylene to a full-tang blade. Poly handle is comfortable and chemical resistant.

PROCUT—STIFF

Item No.	Description
641	1¼" Putty Knife, Chisel Ground, Stiff
643	1¼" Putty Knife, Stiff
645	3" Scraper, Stiff
648	5-in-1 Glazier Knife, Stiff
650	Double-Ended Window Tool, Stiff



STIFF



#648
5-in-1 Glazier
Knife, Stiff

#688
6" Angle Broad
Knife, Flex

PROCUT—FLEX

Item No.	Description
642	1¼" Putty Knife, Flex
646	3" Putty Knife, Flex
647	4" Broad Knife, Flex
649	6" Broad Knife, Flex
651	6" Broad Knife, Steel Head, Flex
688	6" Angle Broad Knife, Flex



FLEX



#651
6" Broad Knife
Steel Head, Flex

#180
1¼" Putty Knife
Stainless Steel, Stiff

180 Series

Rugged, hard-working line for light-duty construction or home projects. Economical tools feature blades of spring stainless steel for easy spreading and easy cleanup. Rust resistant, too. Handles are polypropylene to resist paint thinners and adhesive solvents during cleanup.



#183
3" Putty Knife
Stainless Steel, Flex

#186
6" Broad Knife
Stainless Steel, Flex



STIFF

180 SERIES—STIFF

Item No.	Description
180	1½" Putty Knife, Stainless Steel, Stiff
181	3" Scraper, Stainless Steel, Stiff
185	5-in-1 Glazier Knife, Stainless Steel, Stiff



FLEX

180 SERIES—FLEX

Item No.	Description
182	1½" Putty Knife, Stainless Steel, Flex
183	3" Putty Knife, Stainless Steel, Flex
184	4½" Broad Knife, Stainless Steel, Flex
186	6" Broad Knife, Stainless Steel, Flex
198	8" Broad Knife, Stainless Steel, Flex
199	10" Broad Knife, Stainless Steel, Flex
1081	180 Series Assortment includes 10 Each of Best Sellers, Stiff and Flex (See Page 53)

900 Series

High-value, low-cost spreaders are made of tough polystyrene. Made and priced to be perfect for one-time project use. Features a chisel edge to aid fine spreading or to allow light scraping on soft surfaces.

Plastic tools are perfect for one-time use, such as spreading tar, adhesive, roof caulking, wood putty or other difficult to clean materials.



900 SERIES—FLEX

Item No.	Description
902	1½" Putty Knife, Flex
904	2" Putty Knife, Flex
903	3" Putty Knife, Flex
905	4" Broad Knife, Flex
901	6" Broad Knife, Flex
914	Corner Trowel, Inside, Flex
1092	900 Series Assortment Includes 20 Each of Best Sellers (See Page 53)

Retractable Scraper and Spreader

Two tools in one. Has 1¼"-wide stainless steel blade which extends and locks at 1" for scraping or 2¼" for spreading. Push button extends and retracts blade to a locked position. Durable plastic casing. Another Warner innovation. Patent pending.



RETRACTABLE SCRAPER AND SPREADER

Item No.	Description
597	1¼" Retractable Scraper and Spreader, Carded
598	1¼" Retractable Scraper and Spreader, Bucket Display, 20 with Belt Clip
15597	1¼" Retractable Scraper and Spreader, Carded, 12/Clip Strip

PATCHER

Patcher is made of tempered cutlery steel and plated for corrosion resistance. It is ideal for patching and troweling in small, confined areas.

Item No.	Description
442	Patcher, Stiff



TANG-DRIVEN PUTTY KNIFE AND SCRAPER

High-value tools featuring blades of high-quality carbon steel and handles of comfortable hardwood.

Item No.	Description
465	1½" Putty Knife, Tang-Driven, Flex
466	3" Scraper, Tang-Driven, Stiff

Carbide 100X™ Paint Scrapers

"Best New Product" in 1999
American Painting Contractor Magazine

"Best New Product" in 2000
Today's Homeowner Magazine

100X Paint Scrapers with Carbide Blades

How can a Carbide 100X Blade be 10 times sharper than hardened steel? Simple. Warner uses a special grade of tungsten carbide on 100X Paint Scrapers because it is extremely hard and durable. In fact, the softest grade of tungsten carbide composite starts where steel stops.

Carbide 100X Blades are diamond ground to produce an edge 10 times sharper than steel! These blades will scrape more paint, faster and cleaner than any standard, hardened steel blade! That's the performance which has pushed 100X Paint Scrapers to the top of the "most wanted" list in the Warner line.

CARBIDE 100X SCRAPERS

Item No.	Description
823 PRO	5/8" Carbide 100X Scraper with Round Blade
808 PRO	1" Carbide 100X Scraper with Triangle Blade
830 PRO	2" Carbide 100X Push Scraper
803 PRO	2" Carbide 100X Scraper
804 PRO	2" Carbide 100X Scraper with Knob
806 PRO	2 1/2" Carbide 100X Scraper
807 PRO	2 1/2" Carbide 100X Scraper with Knob
6141 PRO	Carbide 100X Scraper Assortment with Knobs (See Page 54)
6142 PRO	Carbide 100X Scraper Assortment (See Page 54)

CARBIDE 100X REPLACEMENT BLADES

Item No.	Description
824 PRO	5/8" Round Blade Carbide 100X
828 PRO	1" Triangle Blade Carbide 100X
813 PRO	2" Double-Edge Blade Carbide 100X
819 PRO	2" Double-Edge Blades Carbide 100X (10-Pack/Box)
814 PRO	2 1/2" Double-Edge Blade Carbide 100X
816 PRO	2 1/2" Double-Edge Blades Carbide 100X (10-Pack/Box)

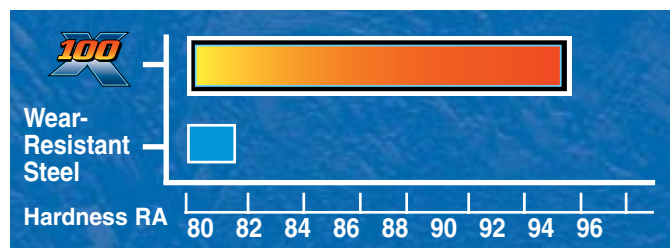

Affordable Scrapers and Blades

Good quality at an economical price. Ideal for light duty, home projects and more. Rugged, comfortable-to-use scrapers have plastic PistolGrip™ handles that arch up for proper leverage. Blades are high-carbon steel, industrial ground, easy to replace and can be re-sharpened as needed.

Choice of two or four scraping edges depending on blade type. Multiple scraping edges save sharpening time to help get more work done in less time.

2-EDGE PLASTIC HANDLE SCRAPERS

Item No.	Description
742	1" Scraper, 2-Edge Blade
740	1¾" Scraper, 2-Edge Blade
741	2½" Scraper, 2-Edge Blade



2-EDGE ALL-METAL SCRAPERS

Item No.	Description
818	1¾" Scraper, Short Handle, 2-Edge Blade
821	1¾" Scraper, 10½" Metal Handle, 2-Edge Blade
822	2½" Scraper, 12" Metal Handle, 2-Edge Blade



4-EDGE PLASTIC HANDLE SCRAPERS

Item No.	Description
730	1" Scraper, PistolGrip, 4-Edge Blade
708	1¾" Scraper, PistolGrip with Knob, 4-Edge Blade
731	1¾" Scraper, PistolGrip, 4-Edge Blade
709	2½" Scraper, PistolGrip with Knob, 4-Edge Blade
732	2½" Scraper, PistolGrip, 4-Edge Blade



2-EDGE REPLACEMENT BLADES

Item No.	Description
810	1" Blades for #742, 2/Card
811	1¾" Blades for #740, #818, #821, 2/Card
812	2½" Blades for #741, #822, 2/Card

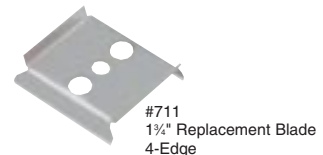

4-EDGE REPLACEMENT BLADES

Item No.	Description
710	1" Blades for #730, 2/Card
711	1¾" Blades for #708, #731, 2/Card
712	2½" Blades for #709, #732, 2/Card

FILE

Keep 2- and 4-Edge Blades razor sharp for best performance with this special file.

Item No.	Description
820	Blade Sharpener File

Specialty Scrapers

Warner Molding Scrapers are designed for curved surfaces around windows and doors. High-carbon steel blades are industrial ground for maximum sharpness.

Scraper #805 offers a 5"-wide blade—widest on the market—and a pivoting head so scraping edges can be rotated easily. Comes with two 2-Edge Blades as does the #809.

SPECIALTY SCRAPERS

Item No.	Description
825	2½" Molding Scraper, Triangular and Teardrop Blade
809	2½" Scraper, Pivot Head, 12" Handle
805	5" Scraper, Pivot Head, 12" Wood Handle



REPLACEMENT BLADES

Item No.	Description
827	2¾" Teardrop Blade for #825
812	2½" Blade for #809
826	2½" Triangular Blade for #825
817	5" Blades for #805, 2/Card

Electric Paint Remover

Provides 1,000 watts of concentrated heat in a 6½" x 3½" heating surface to soften nearly 23 square inches of paint at a time. Features open shield door to get under edge of siding, flip-over resting stand, cool plastic handle and 3-wire ground cord. 120V.

ELECTRIC PAINT REMOVER

Item No.	Description
382	Electric Paint Remover, 1,000 Watt

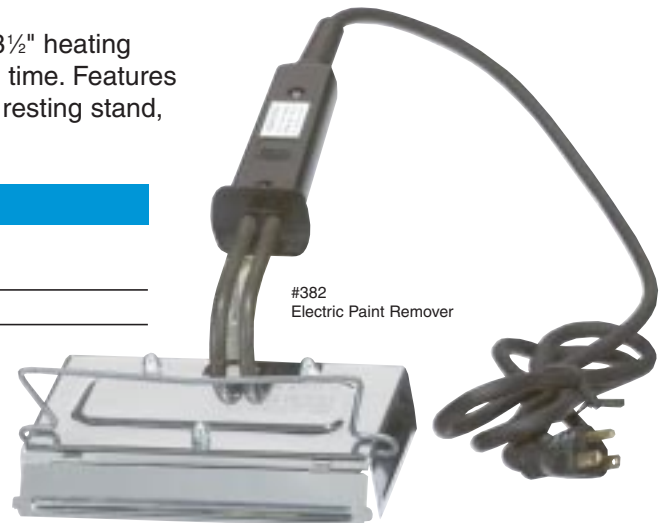

Heavy-Duty Scrapers for Special Applications

Warner Burn-Off Scrapers feature thick, tempered steel blades with a chisel edge. Bent blades or longer wood handles keep fingers away from hot surfaces or chemicals.

BURN-OFF SCRAPERS

Item No.	Description
386	3" Scraper, Bent Burn-Off, 3¾" Handle, Stiff
387	3" Scraper, Bent Burn-Off, 6¾" Handle, Stiff
388	3" Scraper, Straight Burn-Off, 6¾" Handle, Stiff

Brass Blade Scrapers

ProGrip® Brass Blade Scrapers are ideal for metal, glass, porcelain or composite surfaces. Soft brass blades are spark resistant and won't leave scratches.

PROGRIP BRASS BLADE SCRAPERS

Item No.	Description
653	PRO 2" Scraper, Chisel, Brass, Steel Head, Stiff
654	PRO 3" Scraper, Chisel, Brass, Steel Head, Stiff

Painter's Prep Kit

- Includes Safety 1st™ Scraper, Item #103
- 1¼" Plastic 2-Edge Scraper, Item #740
- Mini Glazier Knife, Item #369

Also available is a free-standing, fully assembled #6216 point-of-purchase floor display. Display stands 46" high, 21" wide and 16" deep. Includes 30 #579 items.

PAINTER'S PREP KIT

Item No.	Description
579	Painter's Prep Kit, Carded
6216	Painter's Prep Kit Display on Mini Pallet (30 of Item #579) (See Page 55)

Furniture Refinishing Tool

All-plastic tool is designed for scraping chemically softened finishes. Has radiused edges along the sides for removing material from round chair legs, railings and dowels. The ribbed sides of the blade help collect and hold residue so it doesn't get redistributed over scraped surfaces. Flared corners aid in getting into cracks and crevices. Plastic tool also makes effective scraper for wallpaper.

FURNITURE REFINISHING TOOL

Item No.	Description
393	3" Plastic Refinishing Tool
394	3" Plastic Refinishing Tool, Clip Strip (24/Clip Strip)

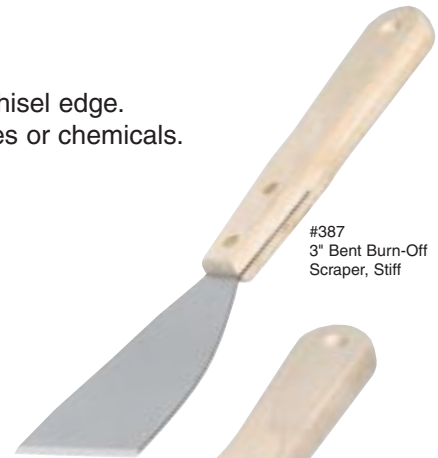

#387
3" Bent Burn-Off
Scraper, Stiff



#388
3" Straight Burn-Off
Scraper, Stiff



#653
2" Brass, Hammer Cap™
Chisel Scraper, Stiff



#579
Painter's
Prep Kit



#393/#394
3" Plastic
Refinishing Tool

Strip 'N' Clean™ Scrapers for the Biggest, Toughest Jobs

Heavy-duty scrapers are made for professionals tackling big scraping jobs—from paint to floor tile. Great for removing adhesives, ceramic wall tile, asphalt tile, carpeting and various industrial applications. Featuring die-cast aluminum scraping heads for maximum blade rigidity and handles of steel or fiberglass with comfortable nonslip grips. The #798 Head-Only Scraper can be used with any standard threaded pole.

STRIP 'N' CLEAN SCRAPERS

Item No.	Description
790 PRO	4" Scraper, 12" Steel Soft Grip Handle, Hammer Cap™
791 PRO	4" Scraper, 18" Steel Handle with Rubber Grip
792 PRO	4" Scraper, 48" Steel Handle
797 PRO	4" Floor Scraper, 54" Fiberglass Handle
799 PRO	6" Floor Scraper, 54" Steel Handle
798 PRO	4" Floor Scraper Head, Threaded (Head Only)



#790
4" Scraper
12" Steel Handle

#797
4" Floor Scraper
54" Fiberglass Handle

#799
6" Floor Scraper
54" Steel Handle

#798
4" Floor Scraper
Head, Threaded



#792
4" Scraper
48" Steel Handle

#791
4" Scraper
18" Steel Handle

#793
4" Strip 'N' Clean
Replacement Blade



#795
8" Strip 'N' Clean
Replacement Blade



STRIP 'N' CLEAN REPLACEMENT BLADES

Carbon steel blades are ground and honed to be super sharp. Strip 'N' Clean Replacement Blades of blue steel come in 4", 6" and 8" widths. They are made to fit any size Warner Strip 'N' Clean Scraper. Blades may be re-sharpened as needed.

Item No.	Description
793 PRO	4" Blade, Blue Steel, Double-Edge
794 PRO	6" Blade, Blue Steel, Single-Edge
795 PRO	8" Blade, Blue Steel, Single-Edge

3½" 4" and 5" Scrapers

Industrial-ground carbon steel blades and big, beefy scrapers can take on practically any scraping job. Tools are designed to deliver maximum leverage on wall and floor surfaces. Multi-purpose scrapers tackle anything from wax buildup to dried adhesives. Scraper #690 is a popular tool used in a wide variety of industries. The #694 Safety 1st™ Scraper is designed for home or light-duty use and the handle is threaded to fit any standard extension pole.

Scrapers are packaged with the blunt edge of the blade exposed. Reverse the blade to expose the sharp edge.

BIG BLADE SCRAPERS

Item No.	Description
694	3½" Safety 1st Wall Scraper, 12" Plastic Threaded Handle
691 PRO	4" Big Blade Scraper, 5" Steel Handle
690 PRO	4" Big Blade Scraper, 9" Steel Handle
680 PRO	4" Big Blade Scraper (#690 with Safety Cover), 9" Steel Handle
693 PRO	4" Big Blade Scraper, 48" Steel Handle
590 PRO	5" Heavy-Duty Scraper, 12" Steel Handle
596 PRO	5" Heavy-Duty Scraper with 2 Blades (Clamshell Pkg. of #590)
591 PRO	5" Heavy-Duty Scraper, 48" Steel Handle



#690
4" Big Blade Scraper
9" Steel Handle



#691
4" Big Blade Scraper
5" Steel Handle

#590
5" Heavy-Duty Scraper
12" Steel Handle



#591
5" Heavy-Duty Scraper
48" Steel Handle

#693
4" Big Blade Scraper
48" Steel Handle



#694
3½" Safety 1st
Wall Scraper

REPLACEMENT BLADE ACCESSORIES

Double-Edge Blades have one edge that is blunt to prevent gouging while scraping, and one edge that is sharpened and honed to industrial standards.

Item No.	Description
685	Safety Cover for 4" Big Blade Scraper
99	3½" Safety 1st Scraper Blades for #694, #100, 5/Card
695 PRO	4" Big Blade Scraper Blades for #680, #690, #691, #693 (5/Card)
699 PRO	4" Big Blade Scraper Blades for #680, #690, #691, #693 (Carton of 100, Bulk)
698 PRO	4" Scraper Blade Dispenser for #680, #690, #691, #693 (Carton of 100 = 10 Cards of 10 Blades)
595 PRO	5" Scraper Blades for #590, #591, #596, 5/Card
599 PRO	5" Scraper Blades for #590, #591, #596, 50/Bulk



#698
4" Scraper Blade
Dispenser



#99
3½" Safety 1st
Scraper Blade



#595
5" Scraper Blade

Glass Scrapers

All of the Safety 1st™ Scrapers in the Warner line have been designed to minimize risk with quick and convenient blade-changing features. Warner is the only company with all safety-style blade-changing systems.

SAFETY 1ST SCRAPERS

Used for a variety of light-duty scraping jobs, from scraping paint off windows to scraping off decals.

Item No.	Description
100	3½" Safety 1st Glass Scraper with 1 Blade/Card
15100	3½" Safety 1st Glass Scraper with 1 Blade, 12/Clip Strip
103	Safety 1st Scraper with 5/Pack Single-Edge Razor Blades
105	Safety 1st Scraper with 1 Single-Edge Razor Blade
15105	Safety 1st Scraper with 1 Single-Edge Razor Blade, 12/Clip Strip
130	Safety 1st Razor Scraper Bucket, 50 of #105/Bucket
356	Safety 1st Utility Scraper with 1 Utility Blade
357	Safety 1st Utility Scraper with 5 (Boxed) Utility Blades



#356/#357
Safety 1st
Utility Scraper



#100
3½" Safety 1st
Glass Scraper



#130
Safety 1st Razor
Scraper Bucket
50/Bucket



#103/#105
Safety 1st
Razor Scraper



#101
Razor Blade Holder Bucket
50/Bucket

RAZOR SCRAPERS

Economical scrapers use standard single-edge razor blade. The blade cover snaps the blade into a locked position, with the blade exposed for cutting or reversed for safety.

Item No.	Description
114	Plastic Neon Razor Blade Holder and Blade, 1/Card
15114	Plastic Neon Razor Blade Holder and Blade, 12/Clip Strip
101	Razor Blade Holders and Blades in Bucket, 50/Bucket



#114
Plastic Neon
Razor Blade Holder
and Blade

Razor Blades

Single-Edge Blades are made to Warner's industrial specifications of high-carbon steel, .009" thick. Blades are ground, honed and tempered for durability.

RAZOR BLADES—SINGLE-EDGE

Item No.	Description
102	Bucket of 5/Pack Razor Blades (100 Packs of 5 = 500 Blades)
108	Display Carton of Razor Blades, 5/Pack (20 Packs of 5 = 100 Blades)
109	PRO Razor Blades, 100 Single-Wrapped, Boxed
110	PRO 10 Razor Blades, two 5-Packs Carded (10 Blades)
112	PRO 100 Razor Blades, Bulk in Plastic Container, Pegable
113	Dispenser of Razor Blade 5-Packs (10 Packs of 5 = 50 Blades)
129	Plastic Dispenser of Single-Edge Blades (10 Blades)



#113
Razor Blade Dispenser
(Carton of 10, 5-Packs)



#99
3 1/2" Safety 1st
Scraper Blade



Razor Blade
Single-Edge

GLASS SCRAPER REPLACEMENT BLADES

Item No.	Description
99	3 1/2" Safety 1st™ Glass Scraper Blades for #100, #694, 5/Card



#362
Notch Tip
Utility Blade



#360-#361
Standard
Utility Blade

UTILITY BLADES

Blades are ground and honed of high-carbon steel. Available as standard Utility Blades or #362 with a hooked edge. All blades are double-notched with a round center hole.

Item No.	Description
360	PRO Utility Blades, 5/Card
361	PRO Utility Blades, 100 Single-Wrapped, Boxed
362	PRO Utility Blades, Notch Tip, 5/Card

10-in-1 and Hawkbill Knives

10-in-1 Folding Tools

They're another Warner innovation—performance that you carry in your pocket. Folding Tools feature stainless steel blades in a secure lockback system. All have a reversible thumb knob for one-hand easy opening and spring-loaded lock for closing.

Nylon handles resist chemicals and solvents and are textured for a nonslip grip. End caps are nickel-plated steel for setting nails or light hammering.



#681
Contractor's Blade
Patent #5,979,058

THE CONTRACTOR'S BLADE™

Designed for the drywall contractor—this tool spackles, scores, saws, scrapes, pounds, trims, rasps, cuts, putty's and cleans! In fact, it's the only multipurpose contractor's tool that folds up!

- Stainless steel blade has two cutting edges, plus a saw edge.

Item

No.		Description
681	PRO	The Contractor's Blade, 5/Shelf Pack
1181	PRO	The Contractor's Blade Counter Display Box, 5/Box
1281	PRO	The Contractor's Blade Plastic Display Rack, 10 Carded

"Innovative Retail Product"
1998 Retailer's Choice Award Winner



#689
Painter's Blade
Patent #5,956,788

THE PAINTER'S BLADE®

Designed for the painter—this tool even helps at cleanup time. It scrapes, spreads compound, cleans caulk, cleans rollers, cuts, pounds, putty's, sets points and cleans cracks. Best of all, it takes just one hand to flick it open, solve the problem, fold it up and get back to painting.

- 1998 Retailer's Choice Award winner for being an innovative product.
- Stainless steel blade with two cutting edges and a roller-shaped cutout to help clean paint rollers.

Item

No.		Description
689	PRO	The Painter's Blade, 5/Shelf Pack
1289	PRO	The Painter's Blade Plastic Display Rack, 10 Carded



#170
2½" Long-Point
Flooring Knife

Hawkbill Knives

Flooring knives for linoleum and vinyl flooring feature hawkbill blades and turned hardwood handles. All have high-carbon cutlery steel blades with the exception of the stainless steel #570 Scalloped Hawkbill Knife. This tool is ideal for cutting shingles, tile or drywall. It has a hardened blade, ground and honed to be super sharp and a highly visible, orange ergo-grip handle for comfort.



#370
2½" Blade
Flooring Knife

#570
4" Hawkbill Knife
Scalloped Blade

HAWKBILL KNIVES

Item

No.		Description
170	PRO	2½" Long-Point Flooring Knife, .075" Thick Blade, Wood Handle
370		2½" Blade Flooring Knife, .050" Thick Blade, Wood Handle
417		Hawkbill Knife, Economy, Wood Handle
570	PRO	4" Hawkbill Knife, Scalloped Blade, Stainless Steel

Razor Knives

Razor Knives have hardwood handles and steel housings to hold blades rigid. Warner's patented blade locking system is an industry exclusive.

RAZOR KNIVES

Item No.	Description
67 PRO	Razor Knife, Larger Wood Handle (Like #170), Locking Mechanism, without Razor Blade
429	Razor Knife, Plain (Same as #490, UPC Sticker on Handle)
490	Razor Knife, Carded with 1 Blade
491	Razor Knife #490 with 5 Razor Blades, Carded
	Razor Blades (See Page 19)



#490
Razor Knife



#119
Heavy-Duty Knife
Snap-Off Blade



#1034
Hobby Knife
Counter Display



#117
Trigger Action Knife
Snap-Off Blade



#124
Hobby Knife
Snap-Off Blade

Snap-Off Blade Knives

Snap-Off Blade Knives offer multiple cutting edges with a locking thumb advance mechanism so a fresh blade is instantly available. Just snap-off the old blade to expose a fresh, sharp edge.

SNAP-OFF BLADE KNIVES

Item No.	Description
117 PRO	Trigger Action Snap-Off Blade Knife with 1 Blade
119 PRO	Heavy-Duty Snap-Off Blade Knife with 1 Blade
123	Wallcovering Cutter, Locking Snap-Off Blade with 2 Blades
15123	Wallcovering Cutter, Locking Snap-Off Blade, 12/Clip Strip
124	Hobby Knife, Snap-Off Blade with 1 Blade, Carded
15124	Hobby Knife, Snap-Off Blade with 1 Blade, 12/Clip Strip
125	Hobby Knife, Snap-Off Blade, Bucket of 40
1034	Hobby Knife, Snap-Off Blade Counter Display, Box of 48

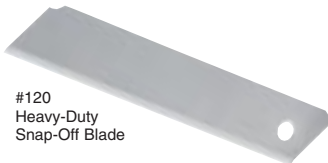

#120
Heavy-Duty
Snap-Off Blade



#116
Snap-Off Blade

SNAP-OFF REPLACEMENT BLADES

Item No.	Description
116	Snap-Off Blades, 13-Point Blade, 5/Card for #117, #123, #124
15116	Snap-Off Blades, 13-Point Blade, 12/Clip Strip
120 PRO	Heavy-Duty Snap-Off Blades, 5/Card for #119

TRIM AND HOBBY KNIFE

Combination Tool is made of plastic and has a built-in 8" ruler plus a 9½" steel trim guide for measuring, marking and cutting wallcoverings. Has built-in knife holder. The hobby knife has 13 snap-off edges. Uses #116 Replacement Blades.

Item No.	Description
135	Combination Trim and Hobby Knife Tool

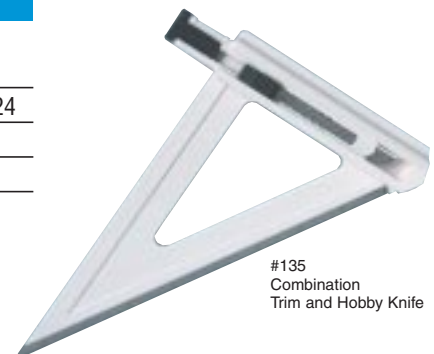

#135
Combination
Trim and Hobby Knife

Utility Knives

Utility Knives feature heavy-duty, die-cast zinc or aluminum housings with ground and honed high-carbon steel blades. Three styles are available: Side or Top Trigger release designs allow blade to be retracted for safety. While the Fixed-Blade version securely clamps the blade in a cutting position. #350 Side Trigger Knife has four locking blade adjustments. Side Trigger Knife accepts all Warner Utility Blades, including the #362 with a center mounting hole.

Unique to the line is the ProCut™ Rasp 'N' Knife which features a zinc body die cast to double as a drywall rasp. A special safety feature of the #566 Safety Utility Knife is a spring-loaded, self-retracting blade. Pressing the trigger exposes the blade. Blade retracts when trigger is released.

#350/#351
Side Trigger
Utility Knife

#366
Top Trigger
Utility Knife

#352
ProCut
Rasp 'N' Knife

#365
ProCut Curved Handle
Utility Knife with Mini Knife

FIXED-BLADE UTILITY KNIVES

Item No.	Description
364 PRO	Fixed-Blade Utility Knife with 3 Blades
352 PRO	ProCut Rasp 'N' Knife, Fixed-Blade with 1 Blade
1052 PRO	ProCut Rasp 'N' Knife (Bucket of 10, Carded #352s)

RETRACTABLE BLADE UTILITY KNIVES

Item No.	Description
349	Plastic Utility Knife with 1 Blade
350 PRO	Side Trigger Utility Knife with 1 Blade
351 PRO	Side Trigger Utility Knife with 5 Blades, (#350 Knife)
365 PRO	ProCut Curved Handle, Heavy-Duty Utility Knife with 1 Blade, FREE Mini Knife Keychain
366	Top Trigger Utility Knife with 3 Blades
15366	Top Trigger Utility Knife with 3 Blades, 12/Clip Strip
368	Keychain Knife, Self-Retracting Blade
15368	Keychain Knife, Self-Retracting Blade, 12/Clip Strip
566	Safety 1st™ Utility Knife, Self-Retracting Blade with 1 Blade
1044	Quick Change Utility Knife Display, 24 Knives



#1044
Quick Change
Utility Knife Display



UTILITY BLADES

Blades are ground and honed of high-carbon steel. Available as standard utility blades or #362 with a hooked edge. All blades are double notched with round center hole.

Item No.	Description
360 PRO	Utility Blades, 5/Card
361 PRO	Utility Blades, 100 Single-Wrapped, Boxed
362 PRO	Utility Blades, Notch Tip, 5/Card

Keeping Things Clean and Neat

Warner provides just what you need for keeping work areas clean and for taking care of brushes and rollers. Brush Combs and Roller Cleaners increase the service life of brushes and rollers and keeps them performing like new. Drop Cloths, in paper or plastic, protect against paint spills.

BRUSH AND ROLLER CLEANERS

Item No.	Description
269	Brush Comb and Roller Cleaner
279	Brush and Roller Cleaner
15279	Brush and Roller Cleaner, 12/Clip Strip
380	Roller-Brush Cleaner, Spins Rollers/Brushes Clean



#380
Roller-Brush
Cleaner



#269
Brush Comb
and Roller Cleaner



#279
Brush and
Roller Cleaner



#411
Swivel
Pot Hook



#412
6" Handy
Pot Hooks



#950
Knee Pads

DROP CLOTHS

Item No.	Description
470	9' x 12' Splatter Cover, Treated Kraft Paper
471	9' x 12' Splatter Cover, 1 Mil. Plastic

POT HOOKS

Another Warner specialty are Pot Hooks which hold paint cans firmly without spilling.

Item No.	Description
411	Swivel Pot Hook
15411	Swivel Pot Hook, 12/Clip Strip
412	6" Handy Pot Hooks, 2/Card

MISCELLANEOUS

Warner's Tack Cloth is the last step before final finish. Cloth collects dust, stays tacky. Economical Plastic Gloves are useful on every job.

Saving knees is the job of Warner Knee Pads. They're essential for refinishing floors, laying tile and more.

Item No.	Description
468	Tack Cloth
463	Plastic Gloves, One Size Fits All, 6/Bag
950	Knee Pads, Solvent-Resistant Black Polypropylene, 1" Elastic Straps with Velcro® Closure

These Specialty Tools Make Jobs Go Faster—and Easier

Unique Graining Tool allows you to put beautiful wood grain finishes on any non-wood surface. Tool comes with full instructions.

Also part of any painter's array of tools are the Mini Roller, Paint Edger and "Bender" Paint Pad. These specialty items paint the areas other rollers and brushes can't. The Paint Can Pour Spout snaps onto one-gallon cans, eliminating paint from running down the side of the can. Plus, the saw tooth edge helps to remove excess paint from your brush.

PAINTING ACCESSORIES

Item No.	Description
16	¼" Round Graining Tool
563	Mini Roller with Tray, Carded
573	Replacement Roller Covers for #563, 2/Card
555	Paint Can Pour Spout, Plastic, Fits 1-Gallon Cans



#16
¼" Round
Graining Tool

#555
Paint Can
Pour Spout



#439
"Bender" Paint Pad



#563
Mini Roller
with Tray

#414
QuickTruss
Door Stand

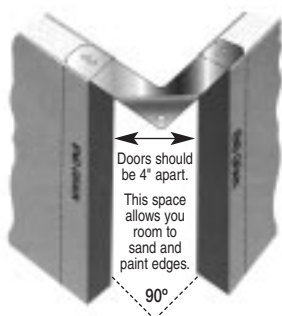

PAINT EDGERS

Item No.	Description
565	2-Wheel Paint Edger
575	Replacement Pad for #565
439	"Bender" Paint Pad with 9" Flex Handle for Hard-to-Reach Areas

DOOR STAND

Special tools make jobs go easier. Like the QuickTruss Door Stand that allows wood-core doors or shutters to stand by themselves for painting or varnishing. The patented "Flat Spikes" eliminate door shifting during preparation and painting. The spikes have been made longer and wider for deeper penetration into the door for better security. Reusable door stands are easy-to-use and quickly removable.

Item No.	Description
414	PRO QuickTruss Door Stand, 6/Card

Spray Shields

Spray Shields provide protection when painting or finishing. They are lightweight to minimize fatigue and are easy to clean. 18" plastic handles with plastic or aluminum blades.

SPRAY SHIELDS

Item No.	Description
305 PRO	24" x 8" Spray Shield, Plastic Blade, Flexible
308 PRO	36" x 8" Spray Shield, Plastic Blade, Flexible
419 PRO	36" x 9" Spray Shield, Aluminum Blade, Flexible

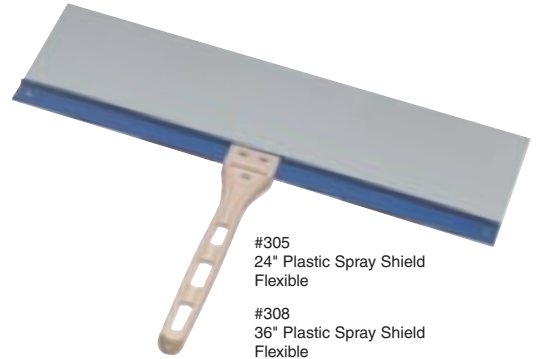

#305
24" Plastic Spray Shield
Flexible

#308
36" Plastic Spray Shield
Flexible



#335
Stainless Steel
Trimmer/Smoothen

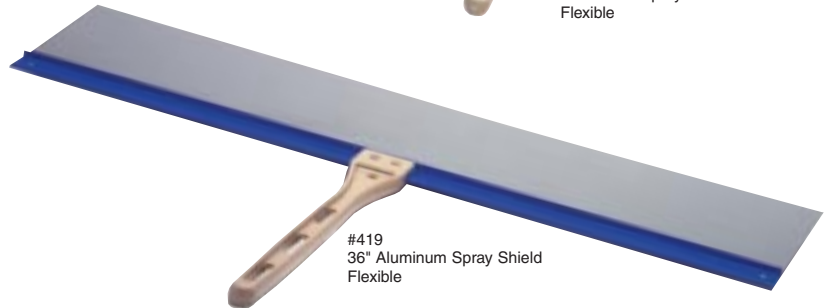

#419
36" Aluminum Spray Shield
Flexible



#430
3-Piece Paint Shield Set



#431
Triple-Edge Guide

Paint and Trim Guides

Thin, flat Paint Guides help give you a perfect edge. They protect molding, trim and non-painted surfaces from spatter and over painting.

PAINT AND TRIM GUIDES

Item No.	Description
435	7 $\frac{3}{4}$ " x 6 $\frac{1}{4}$ " x 9 $\frac{5}{8}$ " Paint 'N' Trim™ Guide, Metal
434	10" Paint Guide (Same Style as #430)
15434	10" Paint Guide, 12/Clip Strip
428	12" Paint Guide and Wallcovering Tool
430	Paint Shield Set, 3-Piece, 1 Each of 6", 10" and 18"
431	Triple-Edge Guide, Plastic
432	15" Paint Guide (Same Style as #430)
433	23" Paint Guide and Wallcovering Tool
335 PRO	11 $\frac{1}{2}$ " x 5 $\frac{1}{4}$ " Trimmer/Smoothen, Stainless Steel



#435
Paint 'N' Trim Guide

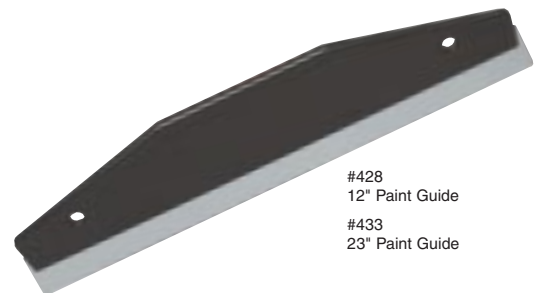

#428
12" Paint Guide

#433
23" Paint Guide

Pry Bars

Rugged tools help remove molding and trim fast and easy. Every toolbox needs one of these Pry Bars.

PRY BARS	
Item No.	Description
743	7½"-Long, Mini Pry Bar
443	9½"-Long, Pry Bar

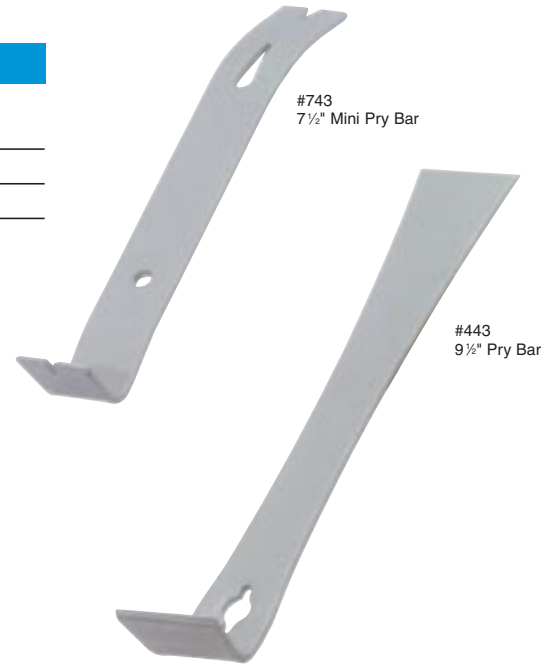

#390
Foam Sanding Block
(Medium Coarse)

#391
Foam Sanding Block
(Medium Fine)



#436
Wood Sanding Block

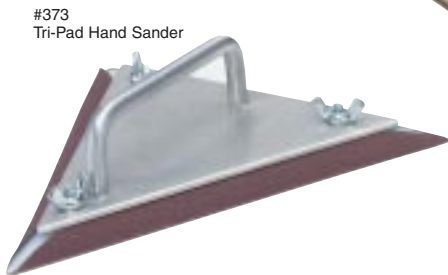

#373
Tri-Pad Hand Sander



#336
Rubber Sanding Block

Sanders

Sanding Blocks are perfect for quick touch-ups or light-duty projects around the house.

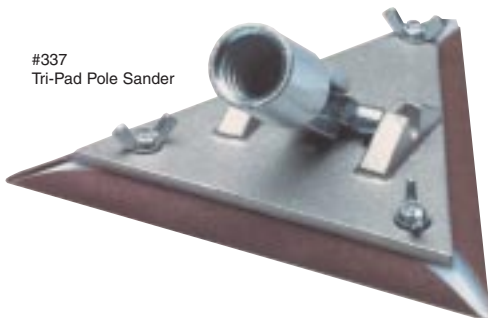

#337
Tri-Pad Pole Sander

#392
Tri-Pad
Replacement
Sandpaper



SANDERS	
Item No.	Description
336	Rubber Sanding Block
390	Foam Sanding Block, Medium Coarse
391	Foam Sanding Block, Medium Fine
436	Wood Sanding Block with Sandpaper
373	PRO Tri-Pad Hand Sander
337	PRO Tri-Pad Pole Sander, Head Only, Female Threaded
392	PRO Tri-Pad Replacement Sandpaper, 120 Grit, 25 Sheets/Pack

Metal, Plastic and Paper Buckets

Warner offers a variety of buckets and pails in paper, plastic and metal. Ideal for all maintenance and construction projects. Economical buckets make work go faster and cleanup easier.

BUCKETS	
Item No.	Description
542	1-Quart Paper Bucket
544	2½-Quart Paper Bucket
553	2½-Quart Metal Bucket
546	5-Quart Metal Bucket
549	5-Quart Plastic Bucket, Steel Rim
550	5-Quart Promotional Plastic Bucket
543	5-Gallon Plastic Bucket



#543
5-Gallon
Plastic Bucket



#553
2½-Quart
Metal Bucket



#550
5-Quart
Promotional
Plastic Bucket



#549
5-Quart
Plastic Bucket
Steel Rim

Bucket Openers

These are essential tools for opening plastic or metal 5-gallon buckets of paint, adhesive or other spreadable compounds. The patented ProGrip® 4-in-1 Bucket Opener/Scraper opens buckets, cuts slots, scrapes and hammers. Display the #1283 Display Box on top of 5-gallon pails and watch the ProGrip Bucket Openers disappear.

The #144 3-in-1 Bucket Opener is a lid cutter, bucket opener and closer. The extra-long handle provides better leverage when opening buckets. Use the hammerhead to pound the lid back onto the bucket. The #556 Bucket Opener is economical and made of very rugged plastic. The #260 Wire Paint Can Opener opens any size metal can with a resealable lid.



#683
ProGrip 4-in-1
Bucket Opener



#556
Plastic Bucket
Opener

BUCKET OPENERS	
Item No.	Description
144	PRO 3-in-1 Bucket Opener, Cast Aluminum
683	PRO ProGrip 4-in-1 Bucket Opener (Shelf Pack)
1283	PRO ProGrip 4-in-1 Bucket Opener, 5/Pack Display Box
556	Plastic Bucket Opener
260	Wire Paint Can Opener, 100/Bulk



#260
Wire Paint Can Opener

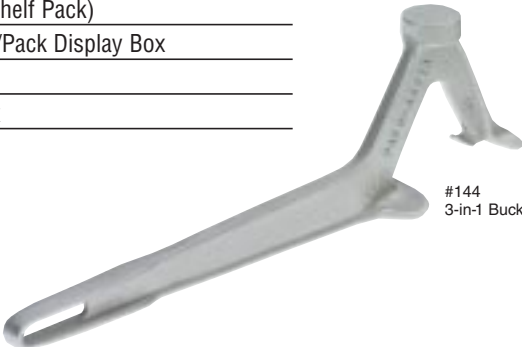

#144
3-in-1 Bucket Opener

Mixers

Use heavy-duty mixing blades for paint, drywall compound, adhesive, driveway coatings and other viscous materials. All have steel shafts for $\frac{1}{2}$ " or $\frac{3}{8}$ " drills except the Mud Masher which is used for hand mixing. Mixer heads reach to the bottom of the bucket. Model #345 Mixer with twin propeller blades has adjustable upper blade.

5-GALLON MIXERS

Item No.	Description
355	5-Gallon Hurricane 5 Mixer, Round Metal Shaft, Fits $\frac{3}{8}$ " Drill
341	5-Gallon Paint Mixer, Spiral Blades, 23 $\frac{1}{2}$ " Shaft, Fits $\frac{3}{8}$ " Drill
446	5-Gallon Paint Mixer, Fits $\frac{3}{8}$ " Drill
345	PRO Mixer, Twin Propeller Blades, 25" Hex Shaft, Fits $\frac{1}{2}$ " Drill
344	PRO 5-Gallon Mixer, Dual Propeller Blade, 30" Hex Shaft, Fits $\frac{1}{2}$ " Drill
347	PRO 5-Gallon Mixer, Dual Propeller Blade, 36" Hex Shaft, Fits $\frac{1}{2}$ " Drill
342	PRO Mud Masher, Hand Mixer, 28" Handle



#345
Adjustable Paint Mixer
Twin Propeller Blades



#355
Hurricane 5 Mixer

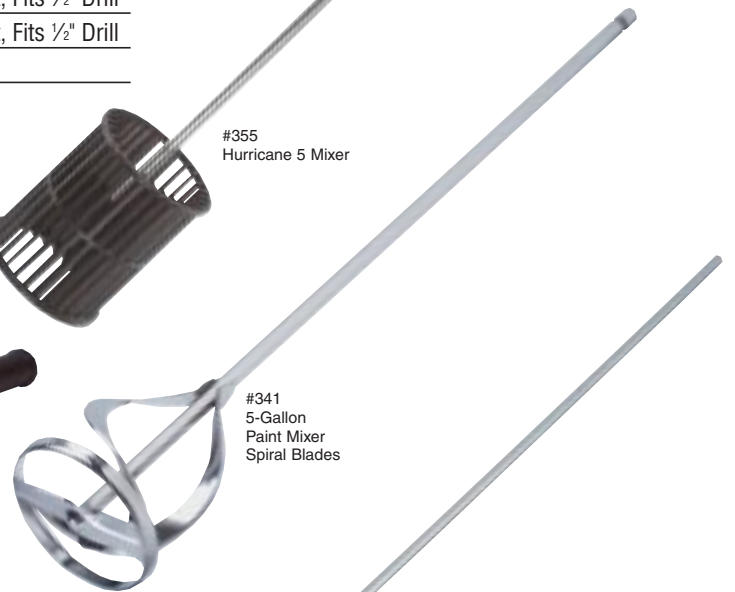

#341
5-Gallon
Paint Mixer
Spiral Blades



#342
5-Gallon
Mud Masher
Hand Mixer



#346
1-Gallon
Turbo Paint Mixer

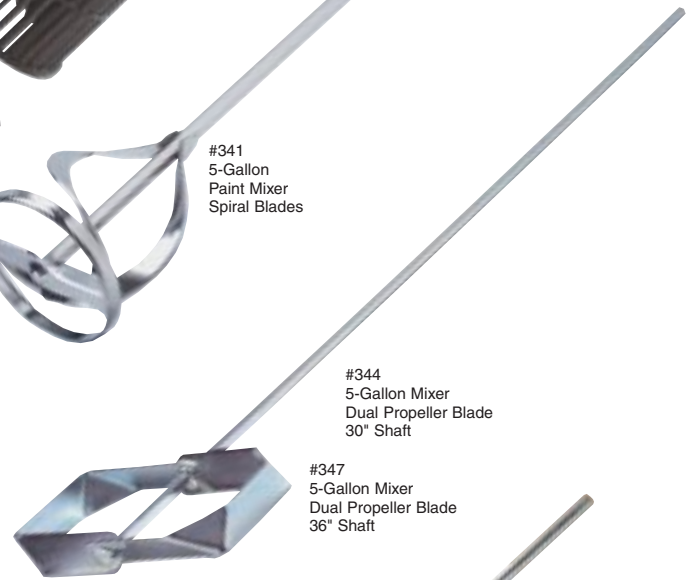

#344
5-Gallon Mixer
Dual Propeller Blade
30" Shaft



#347
5-Gallon Mixer
Dual Propeller Blade
36" Shaft

1-GALLON/1-QUART MIXERS

Item No.	Description
447	1-Gallon Paint Mixer, Metal, Fits $\frac{3}{8}$ " Drill
353	1-Gallon Hurricane 1 Mixer, Gallon/Quart Adjustable, Fits $\frac{3}{8}$ " Drill
270	12" Paint Paddle, Metal
346	1-Gallon Turbo Paint Mixer, Plastic, Fits $\frac{3}{8}$ " Drill



#353
1-Gallon
Hurricane 1 Mixer



#270
12" Paint Paddle
Metal

Glass Cutters

Proper tools make prepping windows for painting practically trouble free. The Glass Cutter has a super-hard cutting wheel and breaking ball. The Plexiglass Cutter has a sharp angled blade to score plexiglass before snapping. It also has a folding blade for safety.

GLASS CUTTERS	
Item No.	Description
138	Glass Cutter
139	Plexiglass Cutter, Folding Blade for Safety



#139
Plexiglass Cutter



#138
Glass Cutter

Window Tools

The Window Opener helps to break windows free after they have been painted shut. The Doubled-Ended Window Tool helps remove old, hardened putty and helps apply new putty for a neat, clean seal. It is the only window tool on the market that offers stainless steel blades for easier cleanup and spreading compound. The 1 5/8" sharp chisel edge is the largest window blade on the market, making compound removal faster and easier. The glazing blade is angled to give you a perfect bead every time.

WINDOW TOOLS	
Item No.	Description
142	Glazier Push Points
395	Double-Ended Window Tool
268	Window Opener



#395
Double-Ended
Window Tool



#268
Window Opener



#142
Glazier Push Points

Fiberglass and Aluminum Poles

High-quality Pro-X-Tend™ adjustable extension poles are a combination of fiberglass and aluminum for making them lightweight and incredibly durable. Poles feature standard 3/4" adapter thread and a push-button lock to prevent aluminum inner pole from twisting. Two-piece poles extend to double their retracted length.

FIBERGLASS AND ALUMINUM POLES

Item No.	Description
90704	PRO 2'-4' Pro-X-Tend Pole, Fiberglass/Aluminum, Button Lock
90706	PRO 3'-6' Pro-X-Tend Pole, Fiberglass/Aluminum, Button Lock
90708	PRO 4'-8' Pro-X-Tend Pole, Fiberglass/Aluminum, Button Lock
90712	PRO 6'-12' Pro-X-Tend Pole, Fiberglass/Aluminum, Button Lock
90716	PRO 8'-16' Pro-X-Tend Pole, Fiberglass/Aluminum, Button Lock
7033	PRO Pro-X-Tend Assortment, 8 Poles (See Page 54)
7034	PRO Pro-X-Tend Assortment, 12 Poles (See Page 54)



Button Lock



#90706
3'-6' Pro-X-Tend Pole



#90704
2'-4' Pro-X-Tend Pole

Steel Poles

Handy extension poles are made of tough steel tubing and are an excellent value. End-cap adapter is nylon and fits standard 3/4" thread accessories. Twist lock secures adjustable poles at any point out to full extension.

STEEL POLES

Item No.	Description
145	2½'-5' Steel Pole, Adjustable, Male Thread, Twist Lock
262	4'-6½' Steel Pole, Adjustable, Male Thread, Twist Lock
146	48" Steel Pole, Fixed, Male Thread



Pro-X-Tend Poles



#262
4'-6½' Handle
Steel Adjustable Extension Pole



#145
2½'-5' Handle
Steel Adjustable Extension Pole



#146
48" Steel Fixed Extension Pole

Threaded Scrapers

Warner threaded scrapers attach to a choice of extension poles for overhead and hard-to-reach scraping jobs. Professional painters, maintenance crews and window cleaners use Warner Pole Accessories to save time and do a better job.

THREADED SCRAPERS

Item No.		Description
397	PRO	3" Bent Scraper, Threaded Handle, Stainless Steel
398	PRO	3" Scraper, Threaded Handle, Stainless Steel
694		3½" Safety 1st™ Wall Stripper, 12" Plastic Threaded Handle
99		3½" Safety 1st Scraper Blade for #694
798*	PRO	4" Floor Scraper Head, Threaded (Head Only)
396	PRO	5-in-1 Glazier Knife, Threaded Handle, Stainless Steel
657	PRO	6" Bent Scraper, Threaded Handle, Stainless Steel, Stiff
658	PRO	6" Scraper, Threaded Handle, Stainless Steel, Flex

*(See Pages 16 and 17 for Replacement Blades)



#396
5-in-1 Glazier Knife
Stainless Steel



#798
4" Floor Scraper Head



#397
3" Bent Scraper
Stainless Steel



#99
3½" Safety 1st
Scraper Blade



#657
6" Bent Scraper
Stiff



#694
3½" Safety 1st
Wall Stripper

Taping Knives

Warner offers a wide range of Taping Knives. Typically the 6" and 8" knives are used for setting tape and the 10"–12" blades are used for applying finish coats. Blades are supported with aluminum or steel backings.

Taping Knife Features:

- Heat-treated and annealed for blade tension and toughness.
- Blue steel blades are polished to high luster for ease of application and cleanup.

Professional Aluminum Backing Plate

Aluminum backing plates provide blade rigidity while making these knives up to 40% lighter than standard taping knives. They provide greater comfort and reduce fatigue. Hollow poly handle is molded to the extruded aluminum backing plate so it can't come loose. Blade flares out at edges to reach into corners. Blue steel or stainless steel blades. Lightweight poly handles.

TAPING KNIVES – POLY HANDLE

Item No.	Description
746	PRO 6" Taping Knife, Blue Steel
748	PRO 8" Taping Knife, Blue Steel
750	PRO 10" Taping Knife, Blue Steel
752	PRO 12" Taping Knife, Blue Steel
758	PRO 8" Taping Knife, Stainless Steel
760	PRO 10" Taping Knife, Stainless Steel
762	PRO 12" Taping Knife, Stainless Steel

#758
8" Taping Knife
Stainless Steel



#233
8" Taping Knife
Blue Steel



#752
12" Taping Knife
Blue Steel



#264
10" Broad Knife
Stainless Steel



Aluminum Backing Plate

Knives feature an extruded aluminum backing plate and shaped wood handles which are securely riveted to a blue steel or stainless steel blade.

TAPING KNIVES – WOOD HANDLE

Item No.	Description
233	8" Taping Knife, Aluminum Back, Blue Steel
234	10" Taping Knife, Aluminum Back, Blue Steel
235	12" Taping Knife, Aluminum Back, Blue Steel
263	8" Broad Knife, Aluminum Back, Stainless Steel
264	10" Broad Knife, Aluminum Back, Stainless Steel
265	12" Broad Knife, Aluminum Back, Stainless Steel

Blue Steel, Steel Backing Plate

Recommended for the most challenging conditions. These knives feature a steel backing plate spot-welded to the knife blade. Blade can't work loose or lose its spring. Knives feature blue steel blades and contour wood handles for added comfort.

TAPING KNIVES – BLUE STEEL

Item No.	Description
297 PRO	8" Taping Knife, Steel Back, Blue Steel
298 PRO	10" Taping Knife, Steel Back, Blue Steel
299 PRO	12" Taping Knife, Steel Back, Blue Steel

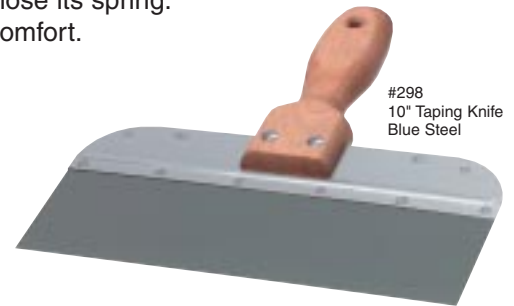

Molded Backing Plates

High-impact handle of molded plastic makes these knives an excellent value. 40% lighter than ordinary knives. Stainless or blue steel blades.

TAPING KNIVES – ECONOMY

Item No.	Description
191	6" Taping Knife, Blue Steel
192	8" Taping Knife, Blue Steel
193	10" Taping Knife, Blue Steel
160	6" Taping Knife, Stainless Steel
161	8" Taping Knife, Stainless Steel
162	10" Taping Knife, Stainless Steel
163	12" Taping Knife, Stainless Steel



ProGrip® Drywall Broad Knife

Warner's exclusive, soft polymer handle has set a new standard in user comfort. Larger handle also reduces fatigue and minimizes repetitive motion stress. Hollow ground, .060" thick carbon steel blade. High luster polish. Hammer Cap™ for light nail setting.

DRYWALL BROAD KNIVES

Item No.	Description
682 PRO	10" Broad Knife, Hammer Cap



Offset Taping Knife

Warner developed this knife by combining the best features of a drywall trowel and a taping knife. It is designed to produce the perfect drywall joint with less effort. Offset handle has soft rubber grip to minimize fatigue. Stainless steel blade with flared corners. Aluminum backing plate.

OFFSET TAPING KNIFE

Item No.	Description
300 PRO	12 7/8" Offset Taping Knife, Stainless Steel



Corner and Curved Trowels

Stainless steel blades are corrosion proof and long lasting. Adjustable Trowel can handle a variety of wall-ceiling applications. Reversible handle on the adjustable trowels give you two tip angles.

INSIDE CORNER TROWELS—FIXED AND ADJUSTABLE

Item No.	Description
131 PRO	88°–155° Bull Nose Inside Corner Trowel, Adjustable
214 PRO	89°–150° Inside Corner Trowel, Adjustable
190	90° Inside Corner Taping Knife, Steel Blade, Plastic Handle
217 PRO	90° Inside Corner Trowel
914	90° Plastic Inside Corner Trowel



#131
88°–155°
Adjustable Inside
Bull Nose Trowel



#214
89°–150°
Adjustable Inside
Corner Trowel



#217
90° Inside Corner
Trowel



#148
3/4" Outside Bull Nose Trowel
Adjustable, Flex



#149
1 1/2" Outside Bull Nose Trowel
Adjustable, Flex



#921
14" x 4" Curved
Blade Trowel



#973
5 1/2" x 11"
EIFS Plastic Float



#976
Red Rubber Float



#303
18" Drywall Finishing
Smoother with Blade Cover

#304
22" Drywall Finishing
Smoother with Blade Cover

OUTSIDE CORNER TROWELS

Bull Nose Trowels (#148–#149) are used to quickly knock down mud on outside bull nose corners. Use the #249 to apply mud to corners.

Item No.	Description
148 PRO	3/4" Outside Bull Nose Trowel, Plastic Handle, Adjustable, Flex
149 PRO	1 1/2" Outside Bull Nose Trowel, Plastic Handle, Adjustable, Flex

FLOATS AND TROWELS

Floats are used for finishing or smoothing drywall compound, stucco, concrete or grout. The curved blade on a drywall trowel puts a perfect crown on finish joints.

Item No.	Description
921	14" x 4" Curved Blade Trowel
922	11" x 4 1/2" Curved Blade Trowel
973	5 1/2" x 11" EIFS Plastic Float
976 PRO	Red Rubber Float

DRYWALL SMOOTHERS

Soft, flexible blades for smoothing sprayed surfaces. Smoothes rough and uneven surfaces, including paint, drywall joints and stucco. Comfortable foam handle has threaded end cap for extension pole. Blade cover included.

Item No.	Description
303 PRO	18" Drywall Finishing Smoother with Blade Cover
304 PRO	22" Drywall Finishing Smoother with Blade Cover

Mud Pans

Mud Pans for drywall compound are available in stainless steel, plastic and galvanized steel in 12" and 14" sizes. Mud Pans #196 and #197 have heli-arc welded seams and are leakproof. The other metal Mud Pans listed are spot-welded construction.

A special feature of the #221 Mud Pan is the removable steel blades along each side for knife scraping and easy cleaning.

MUD PANS

Item No.	Description
197 PRO	12" Mud Pan, Heli-Arc Welded, Stainless Steel
207 PRO	12" Mud Pan, Spot-Welded, Stainless Steel
196 PRO	14" Mud Pan, Heli-Arc Welded, Stainless Steel
266 PRO	14" Mud Pan, Spot-Welded, Stainless Steel
206 PRO	12" Mud Pan, Spot-Welded, Galvanized
267 PRO	14" Mud Pan, Spot-Welded, Galvanized
221 PRO	12" Mud Pan, Removable Steel Blades, Plastic



#221
12" Mud Pan
Plastic



#197
12" Mud Pan
Stainless Steel



#206
12" Mud Pan
Galvanized

Hawk

The 12" x 12" Hawk is made of aluminum and features concentric circles engraved in the top surface to prevent mud slides. Has screw-on, removable handle for easy cleanup.



#216
12" x 12" Drywall Hawk

HAWK

Item No.	Description
216 PRO	12" x 12" Drywall Hawk, Aluminum

Sanders

Warner professional sanding heads, pads and blocks are among the most forgiving in the industry. Thick, soft and flexible, they help create the perfect joint or seam.

HAND SANDERS

Hand Sanders include the Tri-Pad® Sander for finishing walls next to ceilings and corners. Has three usable sanding edges and makes perfect seams to minimize callbacks. Sanding Blocks are spongy and affordable. Good for quick touch-ups.

Item No.	Description
208	Hand Sander, Molded Plastic
229 PRO	Pro Hand Sander, Metal Base with Plastic Handle
159 PRO	Pro Hand Sander, Metal Base with Plastic Handle Thicker, Softer Pad
373 PRO	Tri-Pad Hand Sander
392 PRO	Tri-Pad Replacement Sandpaper, 120 Grit, 25 Sheets/Pack

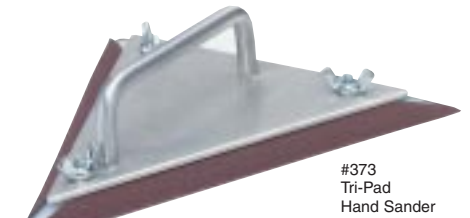

POLE SANDERS

Professional Pole Sanders increase productivity thanks to a swivel head that assures flat surface contact without tipping or rocking. All sanding heads accept standard die-cut sandpaper and 3/4" standard threaded extension poles.

Item No.	Description
156 PRO	Pro Pole Sander, Thicker, Softer, Pad, Male Threaded Only
158 PRO	Pro Pole Sander, Male Head with 48" Pole, Thicker, Softer Pad
337 PRO	Tri-Pad Pole Sander, Head Only, Female Threaded
392 PRO	Tri-Pad Replacement Sandpaper, 120 Grit, 25 Sheets/Pack
209	Pole Sander, Head Only, Female Threaded, Plastic
218 PRO	Pole Sander with 48" Pole, 1/Carton
228 PRO	Pole Sander with 48" Pole (Item #218 Contains 5/Carton)
254 PRO	Replacement Head for #218, Head Only
255 PRO	Replacement Pole for #218, Pole Only
256 PRO	Pole Sander Head with Female Threaded



Saws

ProCut™ Drywall Saw has Warner's sawtooth grind resulting in needle-sharp, long-lasting teeth. Six and one-half inch blade is extremely stiff with a chisel point. Ergonomic grip for comfort. The Warner Keyhole Saw is the value choice for a small multipurpose saw.

SAWS	
Item No.	Description
225	Keyhole Saw, 6" Blade, Plastic Handle
625 PRO	ProCut Drywall Saw, 6½" Blade
141 PRO	ProCut Keyhole Saw, 6½" Blade, Wood Handle
220 PRO	Drywall Saw, 15" Blade, Hardwood Handle

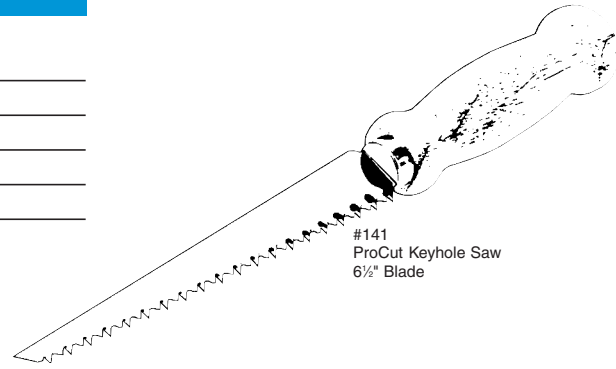

T-Squares

Heavy-duty T-Squares are 3/16" thick aluminum with easy-to-read 1/8" graduations silk screened on the surface. The #223 T-Square is a value version for light-duty use.

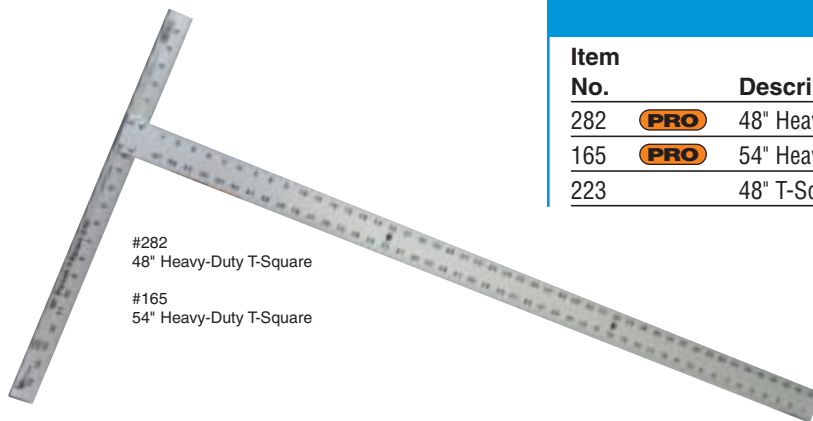

T-SQUARES	
Item No.	Description
282 PRO	48" Heavy-Duty T-Square, 3/16" Thick
165 PRO	54" Heavy-Duty T-Square, 3/16" Thick
223	48" T-Square, 1/8" Thick

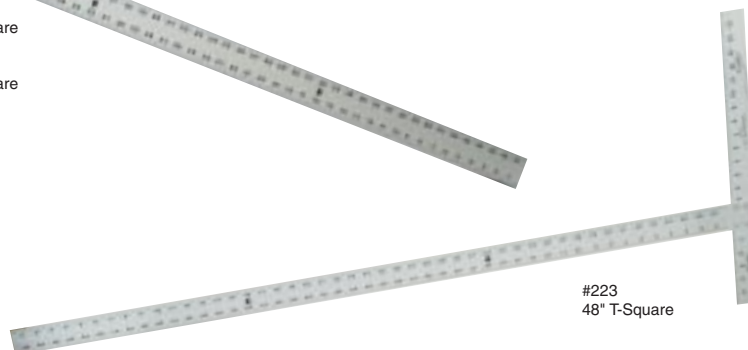

Drywall Kit

This Drywall Kit is ideal for light-duty home projects. Includes all the tools you need for taping and finishing. Broad knife for tape coat, taping knife for finish coats, sander and sandpaper for perfect joints. This Drywall Kit comes in a reusable plastic mud pan. Step-by-step instructions included.

DRYWALL KIT

Contains hand sander, sandpaper, 10" taping knife, 4½" broad knife and instructions. Packed in sturdy, see-through mud pan.

Item

No.	Description
212	Drywall Kit



CIRCLE CUTTERS

Adjustable Circle Cutter has carbon steel cutting wheel to cut ½" to 8" diameter circles. Arm is graduated in inches on one side and millimeters on the other. Has crimped end to prevent loss of center point head.

Item

No.	Description
339 PRO	Circle Cutter, Adjustable
231	Circle Cutter with Replacement Blade
281	Replacement Blades for #231, 10/Card

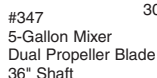
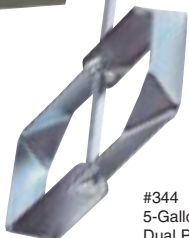
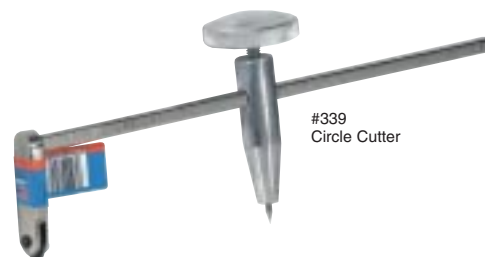

CRIMPER

Corner Crimper sets corner beads fast and easy with a single blow. No nails or screws needed.

Item

No.	Description
338 PRO	1 1/4" Corner Bead Crimper with Rubber Mallet

DRYWALL LIFTERS

These specialty tools save time and make every job easier. Drywall Lifters are a simple design of indestructible material, allowing one person to lift drywall off the floor for installation.

Item

No.	Description
157 PRO	Drywall Boot Roll Lifter
227 PRO	Drywall Toe Lifter

5-GALLON MIXERS

Heavy-duty 5-Gallon Mixers for drywall compound. Mixer heads don't stop short, they reach all the way to the bottom of the bucket. Hexagonal steel shafts fit ½" drills.

Item

No.	Description
345 PRO	Mixer, Twin Propeller Blades, 25" Hex Shaft, Fits ½" Drill
344 PRO	5-Gallon Mixer, Dual Propeller Blade, 30" Hex Shaft, Fits ½" Drill
347 PRO	5-Gallon Mixer, Dual Propeller Blade, 36" Hex Shaft, Fits ½" Drill
342 PRO	Mud Masher, Hand Mixer, 28" Handle

(See Other Mixers on Page 28)

Stilts

Lightweight, aluminum Stilts are perfect for handling walls and overheads where scaffolding and ladders are inconvenient. New Pro-Flex® Leg Bands flex comfortably to fit all leg sizes. Pro-Lite™ Adjustable Stilts adjust fast and easy without tools. Feature dual-spring action to make walking more natural. Stilts have nylon boot straps permanently installed at the factory to prevent accidental loss. Patented Inter-Lok® Bracket for attaching legs—no pins to shear off like other stilts. U.S. Patent #5645515—other patents pending. Other features include adjustable sole and heel plates with rubber sole bottoms. Parts are interchangeable with Dura Stilts. Instruction manual included. Weight limit of 225 lbs.

STILTS

Item No.	Description
132 PRO	18"–30" Pro-Lite Stilts, Pair
133 PRO	24"–40" Pro-Lite Stilts, Pair



Bench

Drywall Bench is manufactured of aircraft aluminum and holds up to 450 lbs. Use it as a walk-up bench, work bench or for scaffolding support. 48" long and 9½" wide with height adjustment from 18" to 30."

Leg adjustment has safety latch to lock legs in place. New latch guard (not shown in photo) gives added safety for accidental latch opening. Bench top has grooves to increase traction, reducing slippage. The #418 Bench folds and is portable, weighing just 35 lbs. Leg extensions include four legs and two additional step bars, allowing height to be increased to 41" and adjusted up to 46½". Legs have 15° angle for increased stability and rubber feet to protect floor surfaces from scratching.

BENCH

Item No.	Description
418 PRO	Bench
407 PRO	Bench Extension Legs with Cross Steps
6562 PRO	Bench Extension Legs without Cross Steps Brace



#6562
Bench Extension Legs
without Cross Steps

#407
Bench
Extension Legs
with Cross Steps

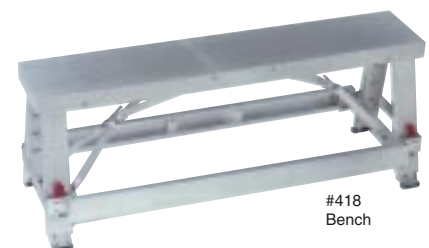

#418
Bench



#418
Bench, Folded

Adhesive Spreaders and Trowels

Warner has a full range of affordable metal tools and economical plastic tools.

STEEL BLADE TROWELS

High-value Steel Blade Trowel is perfect for large jobs around the house. Available in a variety of notches for all types of adhesives. Note: Use adhesive manufacturer's recommendations in choosing proper tooth style. Style similar to #440, #971 (Page 42) and #977 (Page 43).

Item No.	Description
964	Adhesive Trowel, 1/4" x 3/16" V-Notch
968	Ceramic Tile Trowel, 3/16" V-Notch
965	Quarry Tile Trowel, 1/4" Square-Notch
966	Asphalt Tile Trowel, 1/32" and 3/32" U-Notch
967	Vinyl Tile Trowel, 1/16" and 1/32" Square-Notch

ADHESIVE SPREADERS

These handy Spreaders are just the right size for smaller jobs and reaching into crowded areas.

Item No.	Description
188	3" Spreader, 3/16" V-Notch, Stainless Steel Blade, Plastic Handle
189	3" Spreader, 1/16" Square-Notch, Stainless Steel Blade, Plastic Handle
960	5" Trowel, 3/16" V-Notch, Metal (Half Round)
961	5" Spreader, 1/32" Square-Notch, Metal (Half Round)
962	5" Spreader, 1/16" Square-Notch, Metal (Half Round)
963	5" Spreader, 3/32" U-Notch, Metal (Half Round)



#189
3" Square-Notch
Spreader



#909
3" Square-Notch
Spreader



#188
3" V-Notch
Spreader



#908
3" V-Notch
Spreader



#962
5" Square-Notch
Spreader

#978
3/16" V-Notch Trowel

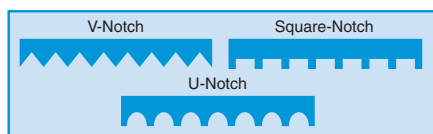

DISPOSABLE PLASTIC ADHESIVE TROWELS AND SPREADERS

Inexpensive plastic tools are perfect for projects involving hard-to-clean adhesives. Save time and energy by using them one time.

Item No.	Description
978	Ceramic and Plastic Tile Trowel, 3/16" V-Notch, Orange
979	Carpet Trowel, 1/16" V-Notch, Black
980	Vinyl Tile Trowel, 1/8" V-Notch for Vinyl Adhesives, Mastics and Epoxies in Kitchens and Bathrooms, Red
981	Ceramic Tile Trowel, 3/8" V-Notch, Ceramic Tile, Green
983	Ceramic Tile Trowel, 1/4" V-Notch, Yellow
984	Vinyl Flooring Trowel, 3/32" V-Notch, White
908	3" Spreader, V-Notch, Plastic
909	3" Spreader, Square-Notch, Plastic

#993
1/8" Tile Spacers

#999
1/4" Tile Spacers

#994
3/16" Tile Spacers



TILE SPACERS

Item No.	Description
993	1/8" Tile Spacers, 100/Box
994	3/16" Tile Spacers, 100/Box
999	1/4" Tile Spacers, 100/Box

Cutters, Saws and Nippers

The Tile Cutting Machine uses a carbide wheel to score tile for a clean break. It features a sturdy plastic base with a rubber bed. Maximum capacity: 12" tiles. Warner offers a wide variety of professional, high-quality tile tools.

CUTTERS, SAWS AND NIPPERS

Item No.	Description
992	Tile Cutting Machine with Carbide Scoring Wheel
989	10" Carbide Rod Saw Blade, Fits Hack Saw Frame
940 PRO	4½" Professional Grout Saw, Plastic Handle
941 PRO	Replacement Blades for #940
985	Ceramic Tile Nipper with Carbide Jaws
987	Ceramic Tile File, Carbide Grit



#985
Ceramic Tile Nipper



#940
4½" Professional Grout Saw



#992
Tile Cutting Machine

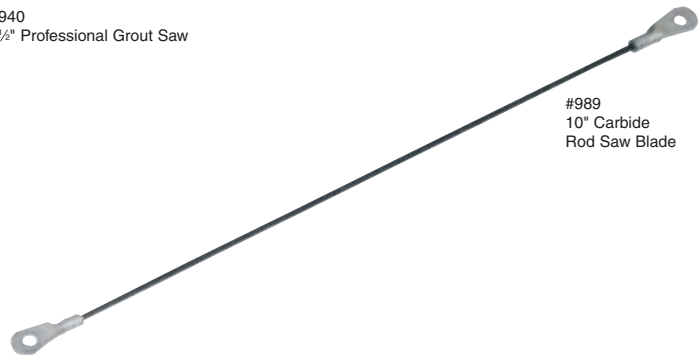

#989
10" Carbide
Rod Saw Blade

Sponge and Spreader

Get professional-looking joints with these specialty tools. #996 spreads grout smoothly, evenly.

SPONGE AND SPREADER

Item No.	Description
995	6½" x 4½" x 2½" Tile Grout Sponge
996	Tile Grout Spreader, Flexible 6" Blade, Wood Handle



#995
Tile Grout Sponge



#996
Tile Grout Spreader

Finishing Trowels

Full line of Trowels for every need, including masonry, cement, drywall, plaster and brick work. Carbon steel blades with sturdy hardwood or molded plastic handles.

FINISHING TROWELS	
Item No.	Description
923	4" x 14" Flat Blade Trowel
924	4½" x 11" Flat Blade Trowel
440	4½" x 10" Finishing Trowel



#924
4½" x 11"
Flat Blade Trowel



#920
2" x 5¼"
Margin Trowel



#440
4½" x 10"
Finishing Trowel

Pointing Trowels

Used for brick laying and making cement joints. Hardened, tempered steel blade with hardwood handle.

POINTING TROWELS	
Item No.	Description
920	2" x 5½" Margin Trowel
916	16" x 4" Cement Trowel
925	7" Gauging Trowel
926	10" Philadelphia Brick Pointing Trowel
927	5½" Brick Pointing Trowel
928	7" Brick Pointing Trowel
929	10" London Brick Pattern Trowel
441	5½" Pointing Trowel
971	7½" Pointing Trowel
972	10" Pointing Trowel



#926
10" Philadelphia
Brick Pointing Trowel



#927
5½" Brick Pointing Trowel



#929
10" London Brick
Pattern Trowel



#971
7½" Pointing Trowel

Floats

Floats are used for finishing or smoothing drywall compound, stucco, concrete or grout. Blade choices include plastic or rubber.

FLOATS

Item No.	Description
977	3" x 7½" Rubber Grout Float
973	5½" X 11" EIFS Plastic Float
975	PRO Professional Rubber Grout Float
976	PRO Red Rubber Float, Aluminum Backing Plate, Plastic Handle



#976
Red Rubber Float



#973
EIFS Plastic Float



#977
Rubber Grout Float

Groover and Jointing Trowels

Cement Groover Trowels have curved edges to prevent gouging. Brick Jointing Trowels produce a smooth mortar joint between cement block or bricks. Steel blades with hardwood handles.

GROOVER AND JOINTING TROWELS

Item No.	Description
933	Cement Groover Trowel
934	2¾" x 6" Cement Edger Trowel
937	¾" x ½" Brick Jointer
938	¾" x ½" Brick Jointer
935	Tuck Pointing Trowel, ¾" x 6" Blade
442	Patcher



#934
Cement Edger Trowel



#442
Patcher



#938
Brick Jointer

Surface Prep and Applicator Brushes

Wire Brushes remove rust, scale and flaking paint. Also for roughing smooth surfaces before applying adhesives.

WIRE BRUSHES

Item No.	Description
572	Mini Brush Set, 3-Piece, Stainless Steel, Brass and Nylon
574	Mini Brass Brush, 7" Plastic Handle
576	Mini Stainless Steel Brush, 7" Plastic Handle
200	Wire Brush, 10 x 4 Rows, Built-in Scraper, 11" Handle
201	Wire Brush, 19 x 3 Rows, 13½" Handle
202	Wire Brush, 16 x 4 Rows, 10" Shoe Handle
203	Wire Brush, 19 x 6 Rows, Straight Back, 7¼" Handle



#574
Mini Brass Brush



#572
3-Piece
Mini Brush Set



#202
Wire Brush
10" Handle

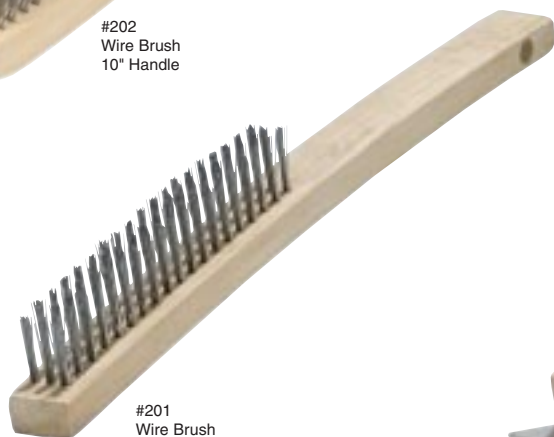

#201
Wire Brush
13½" Handle



#200
Wire Brush Scraper
11" Handle

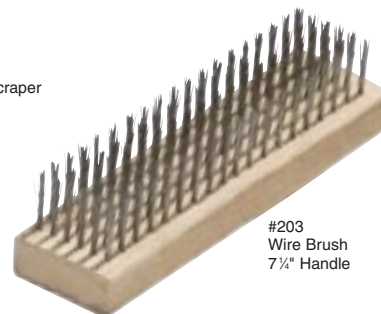

#203
Wire Brush
7¼" Handle



#457
4½" Beveled
Textured Brush

APPLICATOR BRUSHES

Applicator Brushes are used for applying masonry and stucco, adhesives and compounds.

Item No.	Description
457	4½" Beveled Textured Brush
459	6½" Cement Brush

Smoothers

Warner offers a variety of Smoothers for virtually every need. They're made of plastic or foam and come in flexible or stiff for specific uses.

PLASTIC AND METAL SMOOTHERS

Item No.	Description
461	12" Foam Smoother, Flex
335 PRO	11½" Smoother/Trimmer, Stainless Steel, Stiff
431	11½" Smoother/Trimmer Guide, Triple-Edge, Flex
497	9" Plastic Smoother, White, Stiff, Use on Vinyl Paper
498	9" Plastic Smoother, Beige, Flexible, Use on Paper
427	8" Plastic Smoother, Flexible
450	Plastic Wallpaper Smoother, Flexible/European Style
437	6" Wallcovering Smoother/Trimmer



BRUSHES

Wallcovering brushes with the proper stiffness produce a professional appearance.

Item No.	Description
451	12" Smoothing Brush, 1½"-Long Bristles
453	12" x ¾" Trim, Vinyl Brush, ¾"-Long Bristles
474	2-Way Paper Smoother, 1½"-Long Bristles
495	2-Way Vinyl Smoother, ¾"-Long Bristles
456	6" Pasting Brush

#451
12" Smoothing
Brush



#456
6" Pasting Brush



#461
12" Foam Smoother
Flexible

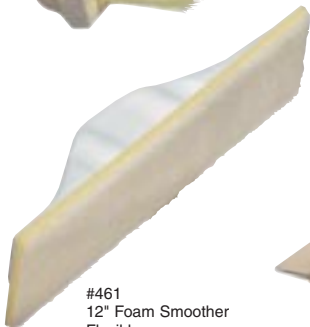

#495
2-Way Vinyl
Smoother



#90
11" Shears
Stainless Steel



SHEARS

Item No.	Description
90	11" Shears, Stainless Steel Blades
15090	11" Shears, Stainless Steel Blades, 10/Clip Strip

Heavy-Duty Professional Rollers

Double- or single-bracket construction with heavy-duty brass bearings. Choice of roller materials. Soft rollers are recommended for delicate mylar or natural fiber papers. Single-bracket rollers go into corners or along ceiling lines. All feature contoured wooden handles.

PROFESSIONAL ROLLERS

Item No.		Description
222	PRO	1" Plastic Roller, Flat Surface, Double Bracket
224	PRO	1" Plastic Roller, Oval Surface, Double Bracket
230	PRO	1" Plastic Roller, Tapered Surface, Single Bracket
30	PRO	1" Hardwood Roller, Flat Surface, Double Bracket
35	PRO	1½" Rubber Roller, Soft, Single Bracket
232	PRO	2" Plastic Roller, Flat Surface, Double Bracket
32	PRO	2" Hardwood Roller, Flat Surface, Double Bracket
47	PRO	2" Steel Roller, Flat Surface, Double Bracket



LIGHTWEIGHT SEAM ROLLERS

Lightweight rollers for occasional projects around the home. Choice of plastic or wood rollers, double or single brackets.

Item No.	Description
415	1" Plastic Roller and Handle, Flat Surface, Single Bracket, Bulk, UPC Labeled
416	Item #415, Carded
15416	1" Plastic Roller and handle, 12/Clip Strip
422	1" Plastic Roller, Flat Surface, Single Bracket, Carded
425	1" Plastic Roller, Flat Surface, Single Bracket, Bulk, UPC Labeled
423	1" Wood Roller, Flat Surface, Double Bracket, Carded
426	1" Wood Roller, Flat Surface, Single Bracket, Bulk, UPC Labeled

Double Seam Cutter

Cuts two overlapping layers of wallpaper so edges match perfectly. Features locking blade and industrial-ground cutting edges.

DOUBLE SEAM CUTTER

Item No.	Description
64 PRO	Double Seam Cutter with 1 Blade
65 PRO	Double Seam Cutter Replacement Blades, 10/Card

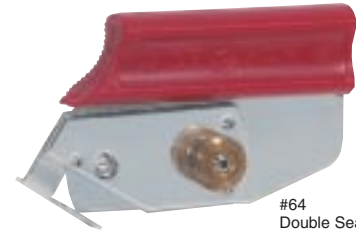

#64
Double Seam Cutter

Wallcovering Kits

Handy kits for light home decorating projects, from adding room borders to hanging prepasted papers and vinyls. The proper tools help get the job done right.

WALLCOVERING KITS—PREPASTED

Kits contain all the tools you need to apply prepasted wallcoverings. Makes each step easy, from cutting to smoothing to cleanup. #494 and #578 includes reusable water tray.

Item No.	Description
494	Prep 'N' Hang™ Prepasted Wallcovering Kit, 30" Water Tray, Patcher/Trim Guide, Seam Roller, Snap-Off Blade Knife with 2 Extra Blades, 2-Way Smoother, Sponge and Instructions
583	Prepasted Wallcovering Kit, Snap-Off Blade Knife, Lump Chalk, Line and Bob, 2-Way Smoother, Trim Guide, Sponge and Instructions, Clam Shell
578	Prep 'N' Hang Border Kit, Water Tray, Smoother, Seam Roller, Snap-Off Blade Knife and Sponge
580	Vinyl Border Kit, Snap-Off Blade Knife, Seam Roller and Smoother



#578
Border Kit



#580
Vinyl Border Kit



#581
Vinyl Wallcovering Kit



#494
Prep 'N' Hang Prepasted
Wallcovering Kit

WALLCOVERING KITS

If you buy wallcovering that is not prepasted, these kits provide all the necessary tools.

Item No.	Description
581	Vinyl Wallcovering Kit, Snap-Off Blade Knife, Lump Chalk, Line and Bob, Pasting Brush, Smoothing Brush, Paint 'N' Trim, Seam Roller and Instructions, Clam Shell
481	Vinyl Hanging Kit, Razor Knife, 5 Extra Blades, Paint 'N' Trim, Seam Roller, Lump Chalk, Plumb Line and Bob, Pasting Brush, Vinyl Smoother and Instructions, Boxed

Accessory Tools

Specialized tools designed by wallcovering professionals to make projects go smoother, faster. They'll help you save time and minimize problems.

ACCESSORY TOOLS	
Item No.	Description
449	7¼" x 3⅝" x 2½" Wallcovering Sponge
187	6" Trim Guide and Patching Tool, Stainless Steel
492	Plastic Wallcovering Trimmer
538	15" Plastic Water Tray for Prepasted Borders
548	30" Plastic Water Tray
250	Wallcovering Perforator Tool with Plastic Head Cover, 19" Handle
437	6" Wallcovering Smoother/Trimmer (1 Sharpened and 1 Rounded Edge)
184	4½" Broad Knife, Flex
435	Paint 'N' Trim™ Guide
134	Lump Chalk, Line and Bob



#449
Wallcovering Sponge



#435
Paint 'N' Trim Guide



#548
30" Plastic
Water Tray



#187
6" Trim Guide
and Patching Tool



#134
Lump Chalk
Line and Bob



#250
Wallcovering Perforator
19" Wood Handle

DUAL-PURPOSE TOOLS

Item No.	Description
428	12" Paint Guide and Wallcovering Tool
433	23" Paint Guide and Wallcovering Tool

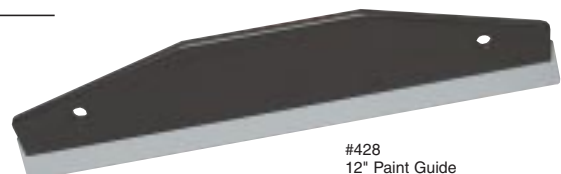

#428
12" Paint Guide

Levels, Rules and Tapes

Durable, high-quality measuring devices are a special Warner value. Essential for practically every project. They belong in every toolbox.

LEVELS, RULES, TAPES AND T-SQUARES

Item No.	Description
293	2' Bubble Stick, Plastic with Level and Plumb Vials
292	4' Bubble Stick, Plastic with Level and Plumb Vials
290	3' Yardstick, Aluminum
296	25' Neon Tape Measure, Plastic Case
287	12' Retractable Tape Measure, Aluminum Case
15287	12' Retractable Tape Measure, 12/Clip Strip
288	25' Retractable Tape Measure, Aluminum Case
282	PRO 48" Heavy-Duty T-Square, $\frac{3}{16}$ " Thick
165	PRO 54" Heavy-Duty T-Square, $\frac{3}{16}$ " Thick
223	48" T-Square, $\frac{1}{8}$ " Thick

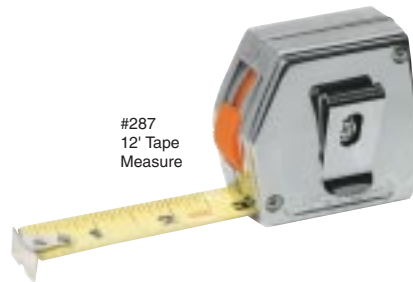

#287
12' Tape
Measure

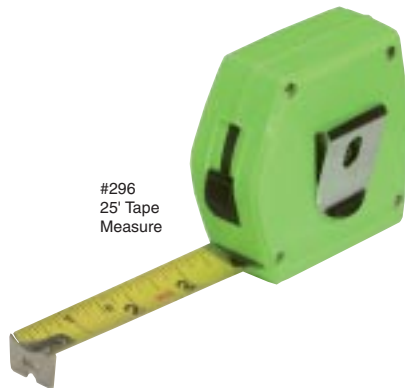

#296
25' Tape
Measure

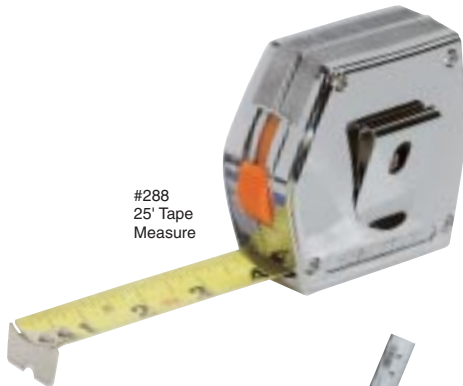

#288
25' Tape
Measure

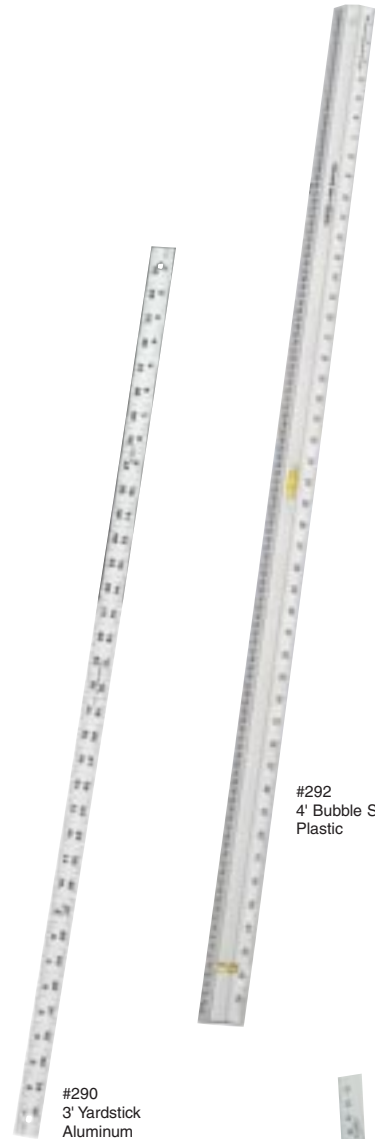

#290
3' Yardstick
Aluminum

#292
4' Bubble Stick
Plastic

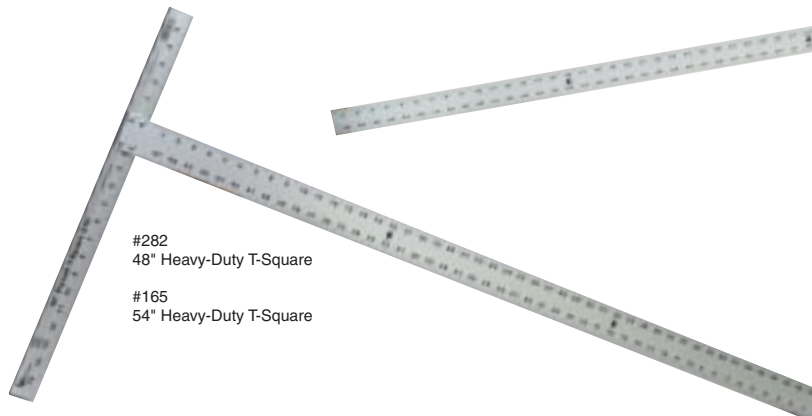

#282
48" Heavy-Duty T-Square

#165
54" Heavy-Duty T-Square

#223
48" T-Square

Clip Strip Promotions

Clip Strips are a quick, convenient way to add extra merchandising space to the selling floor. They help capture impulse sales and add profits.

CLIP STRIPS		CLIP STRIPS	
Item No.	Description	Item No.	Description
394	Refinishing Tool • Stiff blade • 24 per clip strip • Display with paint removers and solvents	15368	Keychain Knife • Self-retracting blade • Blade exposure 3/8" for light cutting • Keychain • 12 per clip strip • Display with keys, packaging and office supplies
15090	11" Shears • Stainless steel blade • Easy-grip contoured handle • 10 per clip strip • Display with wallpaper, office supplies and packaging	15411	Swivel Pot Hook • Nickel plated • 12 per clip strip • Display with painting supplies, ladders and paint
15100	3 1/2" Safety 1st™ Glass Scraper • Retractable blade • Easy to load or replace blade • Blade fully retracts for safety • 12 per clip strip • Display with glass cleaners and office supplies	15416	Wallcovering Seam Roller • Plastic head and handle • 12 per clip strip • Display with wallpaper and borders
15105	Safety 1st Razor Scraper • Easy-to-replace razor blade • 12 per clip strip • Display with glass cleaners, office supplies, automotive and maintenance supplies	15434	10" Paint Guide • 12 per clip strip • Display with paint and stains
15114	Single-Edge Blade Scraper/Holder • Snap blade into locked position • Reverse razor blade for storage or safety • 12 per clip strip • Display with glass cleaner and office supplies	15597	Retractable Scraper/Spreader • 1 1/4" stainless steel blade • 12 per clip strip • Display with spackle and office supplies
15116	Snap-Off Replacement Blades for #123, 5/Card • 13 snap-off blade sections • 12 per clip strip • Display with wallcoverings, borders, packaging or office supplies and #15123 Clip Strip	15690 PRO	4" Scraper, Big Blade • Use to scrape paint, wallpaper and general maintenance • 10 per clip strip • Display with wallpaper and cleaning supplies
15123	Snap-Off Blade Knife • Locking snap-off blade • Two extra blades in handle • 13 snap-off blade sections • 12 per clip strip • Display with wallcovering and office supplies		
15124	Hobby Knife • Snap-off blade • 12 per clip strip • Display with wallcovering and office supplies		
15279	Brush Comb Cleaner • 12 per clip strip • Display with brushes, rollers and paint		
15287	12' Tape Measure • Metal case and belt clip • Stud marks in red • Locking 3/4" wide tape • 12 per clip strip • Display with hammers, saws and wallpaper		
15366	Utility Knife, Top Trigger • Die cast zinc body • Includes three heavy-duty blades • Locking trigger • 12 per clip strip • Display with drywall, packaging and office supplies	#15100	3 1/2" Safety 1st Glass Scraper 12/Clip Strip
		#15411	Swivel Pot Hook 12/Clip Strip
		#15597	Retractable Scraper/Spreader 12/Clip Strip
		#15368	Keychain Knife 12/Clip Strip

Assortments

Practical way to display and sell many of the most popular tools in the Warner line. Countertop displays boost selling impact and increase sales.

#91066 **PRO** PROGRIP2™ STANDARD HANDLE ASSORTMENT

Displays come with 24" six-color Header and Hooks. Includes 5 each of the following: 35 Knives.

Description

1½" Putty Knife, Stiff, #90109

3" Scraper, Stiff, #90115

5-in-1 Glazier Knife, Stiff, #90189

6" Broad Knife, Stiff, #90126

1½" Putty Knife, Flex, #90108

3" Putty Knife, Flex, #90114

4" Broad Knife, Steel Head, Flex, #90124



#90115
3" Scraper
Standard Handle
Stiff



#90114
3" Putty Knife
Standard Handle
Flex



#90178
6" Broad Knife
XL, Steel Head
Flex

#91093 **PRO** PROGRIP2™ HANDLE ASSORTMENT

Displays come with 24" six-color Header and Hooks. Includes 5 each of the following: 35 Knives.

Description

1½" Putty Knife, Stiff, #90109

3" Scraper, XL, Steel Head, Stiff, #90175

8-in-1 Scraper, Steel Head, Stiff, #90173

1½" Putty Knife, Flex, #90108

3" Putty Knife, XL, Steel Head, Flex, #90174

4" Broad Knife, XL, Steel Head, Flex, #90176

6" Broad Knife, XL, Steel Head, Flex, #90178

SPECIALTY SCRAPERS COUNTER DISPLAYS

Item No.	Description
10199 PRO	ProGrip2 6-in-1 Glazier's Knife, Counter Display Box, 10 Tools
10173 PRO	ProGrip2 8-in-1 Painter's Scraper, Counter Display Box, 10 Tools
1283 PRO	ProGrip® 4-in-1 Bucket Opener, Display Box, 5 Tools of #683
1039	ProCut™ Painter's 6-in-1 Scraper, Box of 10 • Chisel edge, high-carbon steel blade • Wood handle with brass Hammer Cap™

#10199
ProGrip2
6-in-1 Display



#10173
ProGrip2
8-in-1 Display



#1283
ProGrip 4-in-1
Bucket Opener
Display



#1076

PRO

600 SERIES FULL FLEX ASSORTMENT

Includes 5 each of the following: 30 Knives.

Description

3/4" Putty Knife, Chisel Ground, Full Flex, #604

1 1/4" Putty Knife, Full Flex, #621

3" Scraper, Full Flex, #633

4" Broad Knife, Full Flex, #635

5" Broad Knife, Full Flex, #636

6" Broad Knife, Full Flex, #637



#604
3/4" Putty Knife
Full Flex

#180

1 1/2" Putty Knife
Stainless Steel
Stiff



#1081

180 SERIES ASSORTMENT

Includes vinyl deader and 10 each of the following: 60 Knives.

Description

1 1/2" Putty Knife, Stiff, #180

3" Scraper, Stiff, #181

1 1/2" Putty Knife, Flex, #182

3" Putty Knife, Flex, #183

4 1/2" Broad Knife, Flex, #184

6" Broad Knife, Flex, #186

#1092

900 SERIES ASSORTMENT

Includes vinyl plan-o-gram header and 20 each of the following: 120 Knives.

Description

1 1/2" Putty Knife, Plastic, Flex, #902

3" Scraper, Plastic, Flex, #903

2" Putty Knife, Plastic, Flex, #904

3" Spreader, Plastic, V-Notch, #908

3" Spreader, Plastic, Square-Notch, #909

4" Broad Knife, Flex, #905



#904
2" Putty Knife
Flex

#7007

700 LINE BLUE STEEL TAPING KNIFE ASSORTMENT

Includes 5 each of the 8", 10" and 12" Knives: 15 Knives. Plus 3 hooks, one Lifetime Guarantee Header and one Drywall Tool Header.

Description

8" Taping Knife, Blue Steel, #748

10" Taping Knife, Blue Steel, #750

12" Taping Knife, Blue Steel, #752



#752
12" Taping Knife
Blue Steel

#7008

700 LINE STAINLESS STEEL TAPING KNIFE ASSORTMENT

Includes 5 each of the 8", 10" and 12" Knives: 15 Knives. Plus 3 hooks, one Lifetime Guarantee Header and one Drywall Tool Header.

Description

8" Taping Knife, Stainless Steel, #758

10" Taping Knife, Stainless Steel, #760

12" Taping Knife, Stainless Steel, #762



#758
8" Taping Knife
Stainless Steel

#7033

PRO

PRO-X-TEND™ ASSORTMENT

Assortment includes 2 each of the following: 8 Poles.

Description

2'-4' Pro-X-Tend, #90704

3'-6' Pro-X-Tend, #90706

4'-8' Pro-X-Tend, #90708

6'-12' Pro-X-Tend, #90712

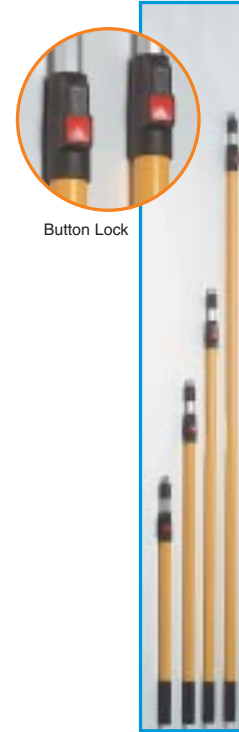

Button Lock

Pro-X-Tend Poles

#7034

PRO

PRO-X-TEND™ ASSORTMENT

Assortment includes 3 each of the following: 12 Poles.

Description

2'-4' Pro-X-Tend, #90704

3'-6' Pro-X-Tend, #90706

4'-8' Pro-X-Tend, #90708

6'-12' Pro-X-Tend, #90712



#6141
Carbide Scraper
with Knob
Assortment

#6141

PRO

CARBIDE 100X™ SCRAPER WITH KNOB ASSORTMENT

Display includes a Header. Assortment includes 3 each of the following tools:

Description

1" 100X Scraper, #808

2" 100X Scraper with Knob, #804

2½" 100X Scraper with Knob, #807

1" 100X Triple-Edge Blade, #828

2" 100X Double-Edge Blade, #813

2½" 100X Double-Edge Blade, #814

#6142

PRO

CARBIDE 100X™ SCRAPER ASSORTMENT

Display includes a Header. Assortment includes 3 each of the following tools:

Description

1" 100X Scraper, #808

2" 100X Scraper without Knob, #803

2½" 100X Scraper without Knob, #806

1" 100X Triple-Edge Blade, #828

2" 100X Double-Edge Blade, #813

2½" 100X Double-Edge Blade, #814



#6142
Carbide Scraper
Assortment

#1289

PRO

PAINTER'S BLADE® DISPLAYS

Plastic counter display contains 10 tools.

Item No.	Description
1289	Painter's Blade, Plastic Counter Display Rack, 10-Pack



#1289
Painter's Blade
Counter Display Rack

CONTRACTOR'S BLADE™ DISPLAYS

Assortments are available as a corrugated box display or a stand-up plastic display. Both show carded tools.

Item No.	Description
1181	PRO Contractor's Blade, Counter Display Box, 5-Pack
1281	PRO Contractor's Blade, Plastic Counter Display Rack, 10-Pack



#1181
Contractor's Blade
Counter Display Box



#6216
Painter's Prep
Kit Display



#1281
Contractor's Blade
Counter Display Rack

MISCELLANEOUS

Item No.	Description
1034	Hobby Knives, Snap-Off, Counter Display Box, 48 Knives
1044	Quick Change Utility Knife, Counter Display Box, 24 Knives
6216	Painter's Prep Kit on Mini Pallet, Holds 30 of Item #579
6719	PRO Wallwik® 20 Display Box on Mini Pallet, Holds 20 of Item #569 Kits
12900	900 Line 3-Pack Dump Box <ul style="list-style-type: none"> • 100 3-packs per display • Each pack includes one; 1½", 3" and 6" belly banded with one UPC code • Pre-packaged display box • Display with caulks and adhesives

#1034
Hobby Knife
Display Box



#1044
Quick Change
Utility Knife Display Box

Bucket Display Assortments

Surveys show that almost 60% of store customers often buy items at the spur of the moment. Our Bucket Displays help attract and sell this bonus business.

BUCKET DISPLAY ASSORTMENTS

Item No.	Description
101	Razor Blade Holder, Plastic, 50/Bucket
102	Bucket of Blades, 5/Box, 100 Boxes
125	Hobby Knife, Snap-Off Blade, 40/Bucket
130	Safety Scraper, 50/Bucket
1052	ProCut™ Rasp 'N' Knife, 10/Bucket
598	Retractable Scraper and Spreader Bucket Display (20 with Belt Clip)

#125
Hobby Knife
Snap-Off Blade
Bucket Display



#130
Safety Scraper
Bucket Display



#1052
ProCut
Rasp 'N' Knife
Bucket Display



#101
Razor Blade Holder
Bucket Display



Bucket Tree Display Assortment

Free-standing Bucket Tree. Base is 26" and the height with the header is 63". Order any 12 items from below and receive 12 buckets, one tree and one header, FREE.* This easy-to-assemble tree must be assembled at retail. Just dump the items ordered into the plastic buckets and watch your sales grow.

BUCKET TREE DISPLAY ASSORTMENT

Item No.	Description	Order Qty.
102	Bucket of Blades, 100 Boxes, 5 Blades/Box	1
105	Safety 1st™ Scraper with 1 Blade	40
110	10 Razor Blades, Carded	20
114	Plastic Neon Razor Blade Holder, Carded	60
119	18mm Heavy-Duty Snap-Off Blade Knife	10
138	Glass Cutter, Carded	10
180	1½" Putty Knife, Stiff	10
181	3" Scraper, Stiff	10
182	1½" Putty Knife, Flex	10
183	3" Putty Knife, Flex	10
260	Wire Paint Can Opener, 100 Bulk	100
287	12" Tape Measure	12
356	Safety 1st Utility Scraper	10
368	Keychain Knife	20
390	Foam Sanding Block, Medium Coarse	10
391	Foam Sanding Block, Medium Fine	10
393	3" Plastic Refinishing Tool	10
411	Swivel Pot Hook	10

Item No.	Description	Order Qty.
415	1" Flat Plastic Seam Roller	20
434	10" Paint Guide	20
463	Plastic Gloves, 6/Bag	20
465	1½" Tang-Driven Scraper	10
466	3" Tang-Driven Scraper	10
468	Tack Cloth	30
572	3-Piece Mini Brush Set, Stainless Steel, Brass and Plastic, Carded	12
574	Mini Brass Brush, Carded	12
576	Mini Stainless Steel Brush, Carded	12
743	Mini Pry Bar	10
902	1½" Plastic Putty Knife	20
903	3" Plastic Scraper	20
908	3" V-Notch Plastic Spreader	20
909	3" Square-Notch Plastic Spreader	20
1034	Hobby Knives in Countertop Display, 48/Box	1
5791	Clear Buckets (12 for #6164 Bucket Tree)	12
6164	Bucket Tree Display	12

*When ordering, add #5791-Buckets (12), #6164-Tree (1) and #5968-Header Card (1) and mark them FREE. (You must order 12 items from above in standard packs to equal order quantity.)

Lectric® Wallpaper Steamer

Profitable tool for rentals. Steamer operates on 110V, 15 amp household current. Draws 1,500 watts. Comes with narrow and medium steam pans, 15' steam hose, hose clamps, 15' electric cord, GFI housing and extra water glass. Includes window banner and rental form pad. U.L. listed—CSA in Canada.

WALLPAPER STEAMER

Item No.	Description
5687 PRO	Lectric Wallpaper Steamer

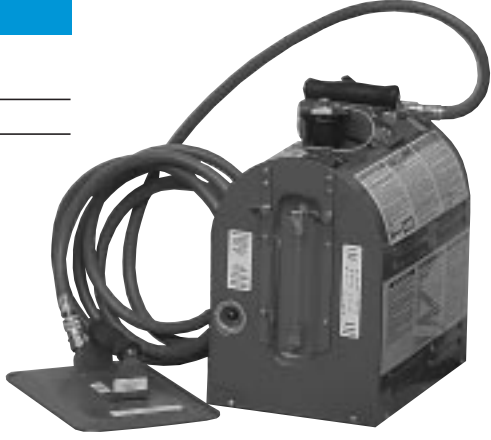

#5687
Lectric Wallpaper Steamer

Floor Strippers

Fast, smooth way for customers to strip off carpet, vinyl or ceramic tile. Floor Stripper features an eccentric drive (no belts) and has an adjustable cutting angle. Operates on 110V, 10 amp current. Stripper Blades come in four sizes.

FLOOR STRIPPER

Item No.	Description
7080 PRO	Electric Floor Stripper, 3/4 HP, without Blade
7001 PRO	10" Floor Stripper Blade – Use for Tough Rubber Back Carpet or Tile
7002 PRO	16" Floor Stripper Blade – Use for Rubber Back Carpet Only
7003 PRO	4" x 6" Floor Stripper Blade – Use for Tile or Sheet Goods, Linoleum on Concrete
7004 PRO	5" x 6" Floor Stripper Blade – Use for Tile or Sheet Goods on Wood Floors



#7080
Electric Floor Stripper



High for Tough Jobs



Low for Shallow Action

Product Index

By Item Number	Page	By Item Number	Page	By Item Number	Page
16	Graining Tool	24	223	T-Square, 48"	37, 50
30	Seam Roller, 1" Hardwood Roller, Double Bracket	46	224	Seam Roller, 1" Plastic Oval Roller, Double Bracket	46
32	Seam Roller, 2" Hardwood Roller, Double Bracket	46	225	Drywall Saw, 6" Blade	37
35	Seam Roller, 1½" Rubber Roller, Single Bracket	46	227	Drywall Toe Lifter	38
47	Seam Roller, 2" Steel Roller, Double Bracket	46	228	Pole Sander	36
64	Double Seam Cutter	47	229	Hand Sander	36
65	Double Seam Cutter Replacement Blades	47	230	Seam Roller, 1" Plastic Tapered Roller, Single Bracket	46
67	Razor Knife, Without Blade	21	231	Circle Cutter with Replacement Blade	38
90	Shears, 11"	45	232	Seam Roller, 2" Plastic Flat Roller, Double Bracket	46
99	Safety 1st Scraper Blade, 3½"	17, 19, 31	233	Taping Knife, Blue Steel, 8"	32
100	Safety 1st Glass Scraper, 3½"	18	234	Taping Knife, Blue Steel, 10"	32
101	Razor Blade Holder, Plastic, 50/Bucket	18	235	Taping Knife, Blue Steel, 12"	32
102	Razor Blades, 500 Blades	19	250	Wallcovering Perforator	48
103	Safety 1st Razor Scraper	18	254	Pole Sander	36
105	Safety 1st Razor Scraper	18	255	Pole for Pole Sander	36
108	Razor Blades, 100 Blades	19	256	Pole Sander	36
109	Razor Blades, 100 Blades	19	260	Paint Can Opener, 100/Bulk	27
110	Razor Blades, 10 Blades	19	262	Extension Pole Adjustable, 4"-6½"	30
112	Razor Blades, 100 Blades	19	263	Broad Knife, Stainless Steel, 8"	32
113	Razor Blades Dispenser, 50 Blades	19	264	Broad Knife, Stainless Steel, 10"	32
114	Plastic Neon Razor Blade Holder	18	265	Broad Knife, Stainless Steel, 12"	32
116	Snap-Off Blades	21	266	Mud Pan, 14"	35
117	Trigger Action Knife, Snap-Off Blade	21	267	Mud Pan, 14"	35
119	Heavy-Duty Snap-Off Blade Knife	21	268	Window Opener	29
120	Heavy-Duty Snap-Off Blades	21	269	Brush Comb and Roller Cleaner	23
123	Wallcovering Cutter, Locking Snap-Off Blade	21	270	Paint Paddle	28
124	Hobby Knife, Snap-Off Blade	21	279	Brush and Roller Cleaner	23
125	Hobby Knife, Snap-Off Blade, 40/Bucket	21	281	Circle Cutter Replacement Blades	38
129	Razor Blades Dispenser, 10 Blades	19	282	T-Square, Heavy-Duty, 48"	37, 50
130	Safety 1st Scraper, 50/Bucket	18	287	Tape Measure, 12"	50
131	Bull Nose Trowel, Adjustable	34	288	Tape Measure, 25"	50
132	Stilts, 18"-30"	39	290	Yardstick, 3"	50
133	Stilts, 24"-40"	39	292	Bubble Stick, 4"	50
134	Lump Chalk, Line and Bob	48	293	Bubble Stick, 2"	50
135	Combination Trim and Hobby Knife Tool	21	296	Tape Measure, 25"	50
138	Glass Cutter	29	297	Taping Knife, Blue Steel, 8"	33
139	Plexiglass Cutter	29	298	Taping Knife, Blue Steel, 10"	33
141	Drywall Saw, 6½" Blade	37	299	Taping Knife, Blue Steel, 12"	33
142	Glazier Push Points	29	300	Taping Knife, Stainless Steel, 12½"	33
144	Bucket Opener, 5-Gallon	27	303	Drywall Finishing Smoother, 18"	34
145	Extension Pole, Adjustable, 2½"-5"	30	304	Drywall Finishing Smoother, 22"	34
146	Extension Pole, Fixed, 48"	30	305	Spray Shield, 24"	25
148	Bull Nose Trowel, Outside, Adjustable, ¾"	34	308	Spray Shield, 36"	25
149	Bull Nose Trowel, Outside, Adjustable, 1½"	34	335	Trimmer/Smoother	25, 45
156	Pole Sander	36	336	Sanding Block, Rubber	26
157	Boot Roll Lifter	38	337	Tri-Pad Pole Sander	26, 36
158	Pole Sander	36	338	Corner Bead Crimper 1½" with Mallet	38
159	Hand Sander	36	339	Circle Cutter, Adjustable	38
160	Taping Knife, Stainless Steel, 6"	33	341	Mixer, Heavy-Duty, 5-Gallon	28
161	Taping Knife, Stainless Steel, 8"	33	342	Drywall Compound Hand Mixer, 5-Gallon	28, 38
162	Taping Knife, Stainless Steel, 10"	33	344	Mixer, 5-Gallon	28, 38
163	Taping Knife, Stainless Steel, 12"	33	345	Mixer, Adjustable Blade, 5-Gallon	28, 38
165	T-Square, Heavy-Duty, 54"	37, 50	346	Paint Mixer, 1-Gallon	28
170	Long Point Flooring Knife, 2½" Blade	20	347	Mixer, 5-Gallon	28, 38
180	Putty Knife, Stainless Steel, Stiff, 1½"	10	348	Utility Knife, Plastic, 30/Bucket	22
181	Scraper, Stainless Steel, Stiff, 3"	10	349	Utility Knife, Plastic	22
182	Putty Knife, Stainless Steel, Flex, 1½"	10	350	Utility Knife, Side Trigger	22
183	Scraper, Stainless Steel, Flex, 3"	10	351	Utility Knife, Side Trigger	22
184	Broad Knife, Stainless Steel, Flex, 4½"	10, 48	352	ProCut Rasp 'N' Knife	22
185	5-in-1 Glazier Knife, Stainless Steel, Stiff	10	353	Paint Mixer, Hurricane 1, 1-Gallon	28
186	Broad Knife, Stainless Steel, Flex, 6"	10	355	Mixer, Hurricane 5, 5-Gallon	28
187	Trim Guide and Patching Tool, 6"	48	356	Safety 1st Utility Scraper	18
188	V-Notch Spreader, 3"	40	357	Safety 1st Utility Scraper	18
189	Square-Notch Spreader, 3"	40	360	Utility Blades	19, 22
190	Corner Taping Knife, Inside	34	361	Utility Blades, 100 Blades	19, 22
191	Taping Knife, Blue Steel, 6"	33	362	Utility Blades, Notch-Tip	19, 22
192	Taping Knife, Blue Steel, 8"	33	364	Utility Knife, Fixed Blade	22
193	Taping Knife, Blue Steel, 10"	33	365	ProCut Curved Handle Utility Knife, Free Mini Knife	22
196	Mud Pan, 14"	35	366	Utility Knife, Top Trigger	22
197	Mud Pan, 12"	35	367	Utility Knife, Fixed Blade, 20/Bucket	22
198	Broad Knife, Stainless Steel, Flex, 8"	10	368	Keychain Knife	22
199	Broad Knife, Stainless Steel, Flex, 10"	10	370	Flooring Knife, 2½" Blade	20
200	Wire Brush Scraper	44	373	Tri-Pad Hand Sander	26, 36
201	Wire Brush	44	375	Paint Edger Replacement Pad	24
202	Wire Brush	44	379	5-in-1 Glazier Knife, Stiff	8
203	Wire Brush	44	380	Roller-Brush Cleaner	23
206	Mud Pan, 12"	35	382	Electric Paint Remover	14
207	Mud Pan, 12"	35	386	Bent Burn-Off Scraper, 3"	15
208	Hand Sander	36	387	Bent Burn-Off Scraper, 3"	15
209	Pole Sander	36	388	Straight Burn-Off Scraper, 3"	15
212	Drywall Kit	38	390	Sanding Block, Foam, Medium Coarse	26
214	Corner Trowel, Inside, Adjustable	34	391	Sanding Block, Foam, Medium Fine	26
216	Drywall Hawk, 12" x 12"	35	392	Tri-Pad Sandpaper	26, 36
217	Corner Taping Knife, Inside	34	393	Plastic Refinishing Tool, 3"	15
218	Pole Sander	36	394	Refinishing Tool, 24/Clip Strip	15, 51
220	Drywall Saw, 15" Blade	37	395	Double-Ended Window Tool	29
221	Mud Pan, 12"	35	396	5-in-1 Glazier Knife, Threaded Handle, Stiff	31
222	Seam Roller, 1" Plastic Roller, Double Bracket	46	397	Bent Scraper, Threaded Handle, Stiff, 3"	31
398	Scraper, Threaded Handle, 3"	31	407	Bench Leg Extensions Kit	39
407	Bench Leg Extensions Kit	39	411	Swivel Pot Hook	23
411	Swivel Pot Hook	23	412	Handy Pot Hooks	23
412	Handy Pot Hooks	23	414	QuickTruss Door Stand	24
414	QuickTruss Door Stand	24	415	Seam Roller, 1" Plastic Roller	46
415	Seam Roller, 1" Plastic Roller	46	416	Seam Roller, 1" Plastic Roller	46
416	Seam Roller, 1" Plastic Roller	46	417	Hawkbill Knife	20
417	Hawkbill Knife	20	418	Bench	39
418	Bench	39	419	Spray Shield, 36"	25
419	Spray Shield, 36"	25	422	Seam Roller, 1" Plastic Roller, Single Bracket	46
422	Seam Roller, 1" Plastic Roller, Single Bracket	46	423	Seam Roller, 1" Wood Roller, Double Bracket	46
423	Seam Roller, 1" Wood Roller, Double Bracket	46	425	Seam Roller, 1" Plastic Roller, Single Bracket	46
425	Seam Roller, 1" Plastic Roller, Single Bracket	46	426	Seam Roller, 1" Wood Roller, Single Bracket	46
426	Seam Roller, 1" Wood Roller, Single Bracket	46	427	Smoother, Flex, 8"	45
427	Smoother, Flex, 8"	45	428	Paint Guide, 12"	25, 48
428	Paint Guide, 12"	25, 48	429	Razor Knife, Plain	21
429	Razor Knife, Plain	21	430	Paint Shield, 3-Piece Set	25
430	Paint Shield, 3-Piece Set	25	431	Triple-Edge Guide	25, 45
431	Triple-Edge Guide	25, 45	432	Paint Guide, 15"	25
432	Paint Guide, 15"	25	433	Paint Guide and Wallcovering Tool, 23"	25, 48
433	Paint Guide and Wallcovering Tool, 23"	25, 48	434	Paint Guide, 10"	25
434	Paint Guide, 10"	25	435	Paint 'N' Trim Guide	25, 48
435	Paint 'N' Trim Guide	25, 48	436	Sanding Block, Wood	26
436	Sanding Block, Wood	26	437	Smoother/Trimmer, 6"	45, 48
437	Smoother/Trimmer, 6"	45, 48	439	Bender Paint Pad	24
439	Bender Paint Pad	24	440	Trowel, Finishing, 10" x 4½"	42
440	Trowel, Finishing, 10" x 4½"	42	441	Trowel, Pointing, 5½"	42
441	Trowel, Pointing, 5½"	42	442	Patcher, Stiff	11, 43
442	Patcher, Stiff	11, 43	443	Pry Bar, 9½"	26
443	Pry Bar, 9½"	26	446	Paint Mixer, 5-Gallon	28
446	Paint Mixer, 5-Gallon	28	447	Paint Mixer, 1-Gallon	28
447	Paint Mixer, 1-Gallon	28	449	Sponge	48
449	Sponge	48	450	Smoother, European Style, Flex	45
450	Smoother, European Style, Flex	45	451	Smoothering Brush, 12"	45
451	Smoothering Brush, 12"	45	453	Brush, Vinyl, 12" x ¾"	45
453	Brush, Vinyl, 12" x ¾"	45	456	Pasting Brush, 6"	45
456	Pasting Brush, 6"	45	457	Texture Brush, 4½"	44
457	Texture Brush, 4½"	44	459	Cement Brush 6½"	44
459	Cement Brush 6½"	44	461	Smoother, Foam, Flex, 12"	45
461	Smoother, Foam, Flex, 12"	45	463	Plastic Gloves	23
463	Plastic Gloves	23	465	Putty Knife, Tang-Driven, Flex, 1½"	11
465	Putty Knife, Tang-Driven, Flex, 1½"	11	466	Scraper, Tang-Driven, Stiff, 3"	11
466	Scraper, Tang-Driven, Stiff, 3"	11	468	Tack Cloth	23
468	Tack Cloth	23	470	Splatter Cover, Paper, 9" x 12"	23
470	Splatter Cover, Paper, 9" x 12"	23	471	Splatter Cover, Plastic, 9" x 12"	23
471	Splatter Cover, Plastic, 9" x 12"	23	474	Smoother, Two-Way	45
474	Smoother, Two-Way	45	481	Wallcovering Vinyl Kit	47
481	Wallcovering Vinyl Kit	47	490	Razor Knife	21
490	Razor Knife	21	491	Razor Knife with 5 Blades	21
491	Razor Knife with 5 Blades	21	492	Wallcovering Trimmer	48
492	Wallcovering Trimmer	48	494	Wallcovering Kit, Prep 'N' Hang	47
494	Wallcovering Kit, Prep 'N' Hang	47	495	Smoother, Two-Way	45
495	Smoother, Two-Way	45	497	Smoother, Stiff, 9"	45
497	Smoother, Stiff, 9"	45	498	Smoother, Flex, 9"	45
498	Smoother, Flex, 9"	45	538	Water Tray, 15"	48
538	Water Tray, 15"	48	542	Bucket, 1-Quart	27
542	Bucket, 1-Quart	27	543	Bucket, 5-Gallon	27
543	Bucket, 5-Gallon	27	544	Bucket, 2½-Quart	27
544	Bucket, 2½-Quart	27	546	Bucket, 5-Quart	27
546	Bucket, 5-Quart	27	548	Water Tray, 30"	48
548	Water Tray, 30"	48	549	Bucket, 5-Quart	27
549	Bucket, 5-Quart	27	550	Bucket, 5-Quart	27
550	Bucket, 5-Quart	27	553	Bucket, 2½-Quart	27
553	Bucket, 2½-Quart	27	555	Paint Can Pour Spout	24
555	Paint Can Pour Spout	24	556	Bucket Opener, 5-Gallon	27
556	Bucket Opener, 5-Gallon	27	558	Wallwik Pro Roll, 100'	49
558	Wallwik Pro Roll, 100'	49	563	Mini Roller with Tray	24
563	Mini Roller with Tray	24	565	Paint Edger, Two-Wheel	24
565	Paint Edger, Two-Wheel	24	566	Safety Utility Knife	22
566	Safety Utility Knife	22	568	Wallwik Scoring Tool	49
568	Wallwik Scoring Tool	49	569	Wallwik Complete Kit	49
569	Wallwik Complete Kit	49	570	Hawkbill Knife, Scalloped, 4"	20
570	Hawkbill Knife, Scalloped, 4"	20	571	Wallwik Refill Kit	49
571	Wallwik Refill Kit	49	572	Mini Brush Set, 3-Piece, Stainless Steel, Brass & Nylon	44
572	Mini Brush Set, 3-Piece, Stainless Steel, Brass & Nylon	44	573	Mini Roller Replacement Covers	24
573	Mini Roller Replacement Covers	24	574	Mini Brush, Brass	44
574	Mini Brush, Brass	44	576	Mini Brush, Stainless Steel	44
576	Mini Brush, Stainless Steel	44	578	Wallcovering Border Kit	47
578	Wallcovering Border Kit	47	579	Painter's Prep Kit	15
579	Painter's Prep Kit	15	580	Wallcovering Vinyl Border Kit	47
580	Wallcovering Vinyl Border Kit	47	581	Wallcovering Vinyl Kit	47
581	Wallcovering Vinyl Kit	47	583	Wallcovering Kit	47
583	Wallcovering Kit	47	590	Heavy-Duty Scraper, 5"	17
590	Heavy-Duty Scraper, 5"	17	591	Heavy-Duty Scraper, 5"	17
591	Heavy-Duty Scraper, 5"	17	595	Scraper Blades, 5"	17
595	Scraper Blades, 5"	17	596	Heavy-Duty Scraper with 2 Blades, #590 Clam Shell, 5"	17
596	Heavy-Duty Scraper with 2 Blades, #590 Clam Shell, 5"	17	597	Retractable Putty Knife, 1½"	11
597	Retractable Putty Knife, 1½"	11			

By Item Number	Page	By Item Number	Page	By Item Number	Page
598	Retractable Scrapers, 20/Bucket, 1½"	11	810	Blades, 2-Edge, 1"	13
599	Scraper Blades, 5"	17	811	Blades, 2-Edge, 1½"	13
601	Chisel Ground Putty Knife, 1½"	8	812	Blades, 2-Edge, 2½"	13, 14
603	Putty Knife, Chisel Ground, Stiff, ¾"	8	813	Carbide 100X Double-Edge Blade, 2"	12
604	Putty Knife, Full Flex, ¾"	9	814	Carbide 100X Double-Edge Blade, 2½"	12
606	Putty Knife, Flex, 1½"	8	816	Carbide 100X Double-Edge Blades, 10/Box, 2½"	12
607	Putty Knife, Stiff, 1½"	8	817	Blades, 5"	14
608	Putty Knife, Flex, 1½"	8	818	Scraper, 2-Edge Blade, 1½"	13
609	Putty Knife, Stiff, 1½"	8	819	Carbide 100X Double-Edge Blades, 10/Box, 2"	12
610	Putty Knife, Flex, 2"	8	820	Blade Sharpener File	13
611	Putty Knife, Stiff, 2"	8	821	Scraper, 2-Edge Blade, 1½"	13
614	Scraper, Flex, 3"	8	822	Scraper, 2-Edge Blade, 2½"	13
615	Scraper, Stiff, 3"	8	823	Carbide 100X Scraper, Round, ¾"	12
618	Broad Knife, Flex, 4"	8	824	Carbide 100X Round Blade, ¾"	12
620	Broad Knife, Flex, 5"	8	825	Molding Scraper, 2½"	14
621	Putty Knife, Full Flex, 1½"	9	826	Triangular Blade, 2½"	14
622	Broad Knife, Flex, 6"	8	827	Tear-drop Blade, 2½"	14
625	Drywall Saw, 6½" Blade	37	828	Carbide 100X Triangle Blade, 1"	12
627	Putty Knife, Full Flex, 1½"	9	830	Carbide 100X Push Scraper, 2"	12
628	Putty Knife, Full Flex, 2"	9	901	Broad Knife, Flex, 6"	11
633	Scraper, Full Flex, 3"	9	902	Putty Knife, Flex, 1½"	11
635	Broad Knife, Full Flex, 4"	9	903	Putty Knife, Flex, 3"	11
636	Broad Knife, Full Flex, 5"	9	904	Putty Knife, Flex, 2"	11
637	Broad Knife, Full Flex, 6"	9	905	Broad Knife, Flex, 4"	11
641	Chisel Putty Knife, Stiff, 1½"	10	908	V-Notch Spreader, 3"	40
642	Putty Knife, Flex, 1½"	10	909	Square-Notch Spreader, 3"	40
643	Putty Knife, Stiff, 1½"	10	914	Corn Trowel, Inside	11, 34
645	Scraper, Stiff, 3"	10	916	Trowel, Cement, 16" x 4"	42
646	Putty Knife, Flex, 3"	10	920	Trowel, Margin, 2" x 5½"	42
647	Broad Knife, Flex, 4"	10	921	Trowel, Curve Blade, 4" x 14"	34
648	5-in-1 Glazier Knife, Stiff	10	922	Trowel, Curve Blade, 4½" x 11"	34
649	Broad Knife, Flex, 6"	10	923	Trowel, Flat Blade, 4" x 14"	42
650	Double-Ended Window Tool, Stiff	10	924	Trowel, Flat Blade, 4½" x 11"	42
651	Broad Knife, Steel Head, Flex, 6"	10	925	Trowel, Gauging, 7"	42
653	Scraper, Chisel, Brass, Stiff, 2"	15	926	Trowel, Philadelphia Brick Pointing, 10"	42
654	Scraper, Chisel, Brass, Stiff, 3"	15	927	Trowel, Brick Pointing, 5½"	42
657	Bent Scraper, Stiff, Threaded Handle, 6"	31	928	Trowel, Brick Pointing, 7"	42
658	Scraper, Flex, Threaded Handle, 6"	31	929	Trowel, London Brick Pattern, 10"	42
680	Big Blade Scraper, #690 with Safety Cover	17	933	Trowel, Cement Groover	43
681	The Contractor's Blade	20	934	Trowel, Cement Edger, 2½" x 6"	43
682	Broad Knife, 10"	33	935	Trowel, Tuck Pointing ¾" x 6"	43
683	Bucket Opener, 5-Gallon	27	937	Brick Jointer, ¾" x ½"	43
685	Safety Cover for 4" Big Blade Scraper	17	938	Brick Jointer, ¾" x ½"	43
688	ProCut Angle Broad Knife, Flex, 6"	10	940	Grout Saw	41
689	The Painter's Blade	20	941	Groul Saw Replacement Blades	41
690	Big Blade Wall Scraper, 4" Blade	17	950	Knee Pads	23
691	Big Blade Wall Scraper, 4" Blade	17	960	V-Notch Spreader, 5"	40
693	Big Blade Wall Scraper, 4" Blade	17	961	Square-Notch Spreader, 5"	40
694	Safety 1st Wall Stripper, 3½"	17	962	Square-Notch Spreader, 5"	40
694	Safety 1st Wall Stripper, Threaded Handle, 3½"	31	963	V-Notch Spreader, 5"	40
695	Big Blade Wall Scraper Blades, 4"	17	964	Adhesive Trowel, ¼ V-Notch	40
698	Scraper Blade Dispenser, 4"	17	965	Quarry Tile Trowel, ¼ Square-Notch	40
699	Scraper Blades, 4"	17	966	Asphalt Tile Trowel, ½" U-Notch	40
708	PistolGrip Scraper with Knob, 4-Edge Blade, 1½"	13	967	Vinyl Tile Trowel, ¼" Square-Notch	40
709	PistolGrip Scraper with Knob, 4-Edge Blade, 2½"	13	968	Ceramic Tile Trowel ¼" V-Notch	40
710	Blades, 4-Edge Blade, 1"	13	971	Trowel, Pointing, 7½"	42
711	Blades, 4-Edge Blade, 1½"	13	972	Trowel, Pointing, 10"	42
712	Blades, 4-Edge Blade, 2½"	13	973	EIFS Float	34, 43
730	PistolGrip Scraper, 4-Edge Blade, 1"	13	975	Grout Float, Rubber	43
731	PistolGrip Scraper, 4-Edge Blade, 1½"	13	976	Red Rubber Float	34, 43
732	PistolGrip Scraper, 4-Edge Blade, 2½"	13	977	Grout Float, Rubber	43
740	Scraper, 2-Edge Blade, 1½"	13	978	V-Notch Trowel, ¾"	40
741	Scraper, 2-Edge Blade, 2½"	13	979	V-Notch Trowel, ½"	40
742	Scraper, 2-Edge Blade, 1"	13	980	V-Notch Trowel, ¼"	40
743	Pry Bar, 7½"	26	981	V-Notch Trowel, ¾"	40
746	Taping Knife, Blue Steel, 6"	32	983	V-Notch Trowel, ½"	40
748	Taping Knife, Blue Steel, 8"	32	984	V-Notch Trowel, ¾"	40
750	Taping Knife, Blue Steel, 10"	32	985	Ceramic Tile Nipper	41
752	Taping Knife, Blue Steel, 12"	32	987	Ceramic Tile File	41
758	Taping Knife, Stainless Steel, 8"	32	989	Carbide Rod Saw Blade, 10"	41
760	Taping Knife, Stainless Steel, 10"	32	992	Tile Cutting Machine	41
762	Taping Knife, Stainless Steel, 12"	32	993	Tile Spacers, ¼"	40
790	Strip 'N' Clean Scraper, 12" Handle, 4"	16	994	Tile Spacers, ¾"	40
791	Strip 'N' Clean Scraper, 18" Handle, 4"	16	995	Tile Grout Sponge	41
792	Strip 'N' Clean Scraper, 48" Handle, 4"	16	996	Tile Grout Spreader	41
793	Strip 'N' Clean Replacement Blade, 4"	16	999	Tile Spacers ½"	40
794	Strip 'N' Clean Replacement Blade, 6"	16	1034	Hobby Knives In Countertop Display Box	21, 55
795	Strip 'N' Clean Replacement Blade, 8"	16	1039	ProCut Painter's 6-in-1 Scraper, Counter Display Box	52
797	Floor Scraper, 54" Handle, 4"	16	1044	Quick Change Utility Knife Display Box	22, 55
798	Floor Scraper Head, 4"	16, 31	1052	ProCut Rasp 'N' Knife, 10/Bucket	22
799	Floor Scraper, 54" Handle, 6"	16	1076	600 Line, Full Flex Assortment	9, 53
803	Carbide 100X Scraper, 2"	12	1081	180 Series, Assortment	10, 53
804	Carbide 100X Scraper with Knob, 2"	12	1092	900 Series, Assortment	11, 53
805	Pivot Head Paint Scraper, 5"	14	1181	The Contractor's Blade, Display Box	20, 55
806	Carbide 100X Scraper, 2½"	12	1281	The Contractor's Blade Display Rack	20, 55
807	Carbide 100X Scraper with Knob, 2½"	12	1283	Bucket Opener, 5-Gallon, Display Box	27, 52
808	Carbide 100X Scraper, Triangular, 1"	12	1289	The Painter's Blade, Display Rack	20, 55
809	Pivot Head Paint Scraper, 2½"	14	5687	Lectric Wall Steamer	57
5791	Clear Buckets (12) for 6164 Bucket Tree	56	6141	Carbide 100X Scrapers with Knob Assortment	12, 54
6142	Carbide 100X Scrapers Assortment	12, 54	6164	Bucket Tree Display, with 12 Clear Buckets	56
6216	Painter's Prep Kit, Mini Pallet, 30/Display	15, 55	6562	Bench Extension Legs (No Step)	39
6719	Wallwik Complete Kit, Mini Pallet, 20/Display	49, 55	7001	Floor Stripper Blade, 10"	57
7002	Floor Stripper Blade, 16"	57	7003	Floor Stripper Blade, 4" x 6"	57
7004	Floor Stripper Blade, 5" x 6"	57	7007	700 Line, Blue Steel Taping Knife Assortment	53
7008	700 Line, Stainless Steel Taping Knife Assortment	53	7033	Pro-X-Tend Pole Assortment, 8 Poles	30, 54
7034	Pro-X-Tend Pole Assortment, 12 Poles	30, 54	7080	Floor Stripper, Electric	57
10173	ProGrip2 8-in-1 Counter Display Box	7, 52	10199	ProGrip2 6-in-1 Counter Display Box	7, 52
12900	900 Line, 3-Pack Dump Box	55	15090	Shears, 11" 10/Clip Strip	45, 51
15100	Glass Scraper, 3½", 12/Clip Strip	18, 51	15105	Safety 1st Razor Scraper, 12/Clip Strip	18, 51
15114	Single-Edge Blade Scraper, 12/Clip Strip	18, 51	15116	Snap-Off Blades, 12/Clip Strip	21, 51
15123	Snap-Off Blade Knife, 12/Clip Strip	21, 51	15124	Hobby Knife, Snap-Off Blade, 12/Clip Strip	21, 51
15279	Brush and Roller Cleaner, 12/Clip Strip	23, 51	15287	Tape Measure, 12" 12/Clip Strip	50, 51
15366	Utility Knife, Top Trigger, 12/Clip Strip	22, 51	15368	Keychain Knife, 12/Clip Strip	22, 51
15411	Swivel Pot Hook, 12/Clip Strip	23, 51	15416	Wallcovering Seam Roller, 12/Clip Strip	46, 51
15434	Paint Guide, 10" 12/Clip Strip	25, 51	15597	Retractable Putty Knife, 12/Clip Strip, 1½"	11, 51
15690	Scraper, Big Blade, 4" 10/Clip Strip	51	24569	Wallwik Complete Kit (Display Box)	49
24571	Wallwik Refill Kit (Display Box)	49	90100	Chisel Putty Knife, Steel Head, Stiff, 1½"	4
90101	Chisel Putty Knife, Stiff, 1½"	4	90106	Putty Knife, Flex, 1½"	5
90107	Putty Knife, Stiff, 1½"	4	90108	Putty Knife, Flex, 1½"	5
90109	Putty Knife, Stiff, 1½"	4	90110	Putty Knife, Flex, 2"	5
90111	Putty Knife, Stiff, 2"	4	90114	Putty Knife, Flex, 3"	5
90115	Scraper, Stiff, 3"	4	90118	Broad Knife, Flex, 4"	5
90119	Broad Knife, Stiff, 4"	4	90120	Broad Knife, Flex, 5"	5
90122	Broad Knife, Flex, 6"	5	90123	Putty Knife, Steel Head, Flex, 3"	5
90124	Broad Knife, Steel Head, Flex, 4"	5	90125	Broad Knife, Steel Head, Flex, 5"	5
90126	Broad Knife, Steel Head, Flex, 6"	5	90127	Putty Knife, Full Flex, 1½"	6
90128	Putty Knife, Full Flex, 2"	6	90129	Broad Knife, Stiff, 6"	6
90131	Putty Knife, Full Flex, 1½"	6	90133	Putty Knife, Full Flex, 3"	6
90135	Broad Knife, Full Flex, 4"	6	90136	Broad Knife, Full Flex, 5"	6
90137	Broad Knife, Full Flex, 6"	6	90171	Putty Knife, Steel Head, Stiff, 2"	4
90172	Putty Knife, XL, Steel Head, Flex, 2"	5	90173	8-in-1 Glazier, Steel Head, Stiff	4
90174	Putty Knife, XL, Steel Head, Flex, 3"	5	90175	Scraper, Steel Head, Stiff, 3"	4
90176	Broad Knife, XL, Steel Head, Flex, 4"	5	90177	Broad Knife, XL, Steel Head, Flex, 5"	5
90178	Broad Knife, XL, Steel Head, Flex, 6"	5	90180	Broad Knife, XL, Steel Head, Full Flex Rated #4, 6"	7
90182	Broad Knife, XL, Steel Head, Full Flex Rated #3, 6"	7	90184	Broad Knife, XL, Steel Head, Full Flex Rated #2, 6"	7
90186	Broad Knife, XL, Steel Head, Full Flex Rated #1, 6"	7	90189	5-in-1 Glazier Knife, Stiff	4
90199	6-in-1 Glazier, Steel Head, Stiff	4	90704	Pro-X-Tend Pole, 2'-4"	30
90706	Pro-X-Tend Pole, 3'-6"	30	90708	Pro-X-Tend Pole, 4'-8"	30
90712	Pro-X-Tend Pole, 6'-12"	30	90716	Pro-X-Tend Pole, 8'-16"	30
91066	ProGrip2 Standard Handle Assortment	7, 52	91093	ProGrip2 XL Handle Assortment	7, 52

Warner, Easy Reach, ProCut, ProGrip, ProGrip2, PistolGrip, Peel 'N' Patch, Patch 'N' Trim, Prep 'N' Hang, Prep 'N' Trim, Strip 'N' Clean, Safety 1st, The Contractor's Blade, The Painter's Blade, Lectric, 100X, The Edge, Carbide 100X The Edge, Pro-X-Tend and Rasp 'N' Knife are registered trademarks of Warner Tool. Tri-Pad, Pro-Lite and Wallwik are registered trademarks.

Retailer Customer Service: (Retailers Only)
800-444-0606 • 763-559-4740

Fax Numbers:
800-455-9883 • 877-927-6370 • 763-559-0613 • 763-559-1364

Consumer Inquiries:
877-Warner-1 or Visit www.warnertool.com for Dealer Locator



13435 Industrial Park Blvd., Minneapolis, MN 55441-3899
www.warnertool.com