

3M™ Versaflo™ Powered and Supplied Air Respiratory Systems

3M™ Versaflo™ M-Series Headgear



Table of Contents

- Regulatory Requirements
- Product Overview
- Product Specifications
- M-Series Faceseals
- M-Series Shrouds
- M-Series Suspensions
- M-Series Visors & Visor Accessories
- M-Series Accessories
- M-Series Spare Parts
- Versaflo™ BT-Series Breathing Tubes
- Donning
- Warranty/Contact Information

Regulatory Requirements

- Read all 3M™ Versaflo™ M-Series Headgear *User Instructions* and warnings before using.
- Occupational use of respirators must be in compliance with applicable health and safety standards.
- By United States regulation employers must establish a written respirator protection program meeting the requirements of the Occupational Safety and Health Administration (OSHA) Respiratory Protection standard 29 CFR 1910.134 and any applicable OSHA substance specific standards. Additional information on this standard can be found at: www.OSHA.gov.
- In Canada, CSA standard Z94.4 requirements must be met and /or requirements of the applicable jurisdiction as appropriate.

3M™ Versaflo™ M-Series Headgear Family



M-100 Series
Faceshields

- Loose Fitting Facepiece, APF 25
- Meets requirements of ANSI Z87.1-2010 (limited eye protection)
- Optional inserts (M-170) available to create a closed shell
- ~29% lighter than 3M L-501 Headgear



M-300 Series
Hardhats

- Loose Fitting Facepiece, APF 25
- Meets requirements of ANSI Z87.1-2010 (limited eye protection)
- Meets requirements of ANSI Z89.1-2003 Type 1 Class G (limited head protection)
- ~17% lighter than 3M L-701 Headgear



M-400 Series
Helmets

- Helmet, APF 1000
- Meets requirements of ANSI Z87.1-2010 (limited eye protection)
- Meets requirements of ANSI Z89.1-2003 Type 1 Class G (limited head protection)
- ~20% lighter than 3M L-901 Headgear

All M-Series Headgear feature a built-in air deflector which allows the wearer to direct the location of the airflow inside the headgear, fully adjustable head suspension, and a variety of fabric options for faceseals and outer shrouds.

3M™ Versaflo™ M-Series Headgear Product Overview



3M™ Versaflo™ M-Series Combinations

3M™ VERSAFLO™ M-SERIES FACESHIELDS, HARD HATS AND HELMETS

M-100 Series Faceshields

APF 25** Respiratory Protection, Eye/Face Protection, Adjustable Airflow

M-105 Faceshield with Standard Visor and Faceseal

M-107 Faceshield with Premium Visor and Faceseal



M-300 Series Hard Hats

APF 25** Respiratory Protection, Head Protection, Eye/Face Protection, Adjustable Airflow

M-305 Hard Hat with Standard Visor and Faceseal

M-307 Hard Hat with Premium Visor and Faceseal



M-400 Series Helmets

APF 1000** Respiratory Protection, Head Protection, Eye/Face Protection, Adjustable Airflow

M-405 Hard Hat with Standard Visor and Shroud

M-407 Hard Hat with Premium Visor and Flame-Resistant Shroud



3M™ VERSAFLO™ BT-SERIES BREATHING TUBES

All BT-Series breathing tubes feature the QRS (Quick Release Swivel) connection for maximum comfort and ease of use.



BT-20S/BT-20L
Light Duty Breathing Tube



BT-30
Length Adjusting Breathing Tube



BT-40
Heavy Duty Breathing Tube

****3M supports an APF of 1000 for the M-400 Series Helmets. Consult product *User Instructions* for additional information or contact 3M.**

3M™ VERSAFLO™ TR-SERIES POWERED AIR PURIFYING RESPIRATORS (PAPRS)

TR-300 Particulate PAPP

TR-305N Standard Belt & Economy Battery

TR-306N High Durability Belt & High Capacity Battery

TR-307N Easy Clean Belt & High Capacity Battery



3M™ VERSAFLO™ V-SERIES SUPPLIED AIR VALVES

V-Series Valves

V-100 Vortex Cooling Assembly

V-200 Vortemp™ Heating Assembly

V-300 Air Regulating Valve Assembly

V-400 Low Pressure Connector Assembly

All V-Series Supplied Air Valves require a supplied air hose to complete the NIOSH-approved respirator system. These hoses are available in many different lengths and are sold separately.



3M™ GVP-SERIES POWERED AIR PURIFYING RESPIRATORS (PAPRS)

Intrinsically Safe/NiCd

GVP-1 Assembly

GVP-1U with Vinyl Belt

GVP-CB with Comfort Belt

NiMH

GVP-1NiMH

GVP-1UNiMH with Vinyl Belt

GVP-CBNiMH with Comfort Belt

All GVP-Series PAPRs require a cartridge or filter (both sold separately) to complete the NIOSH-approved respirator system.



3M™ Versaflo™ M-Series Combinations

3M™ VERSAFLO™ M-SERIES FACESHIELDS, HARD HATS AND HELMETS

M-100 Series Faceshields

APF 25** Respiratory Protection, Eye/Face Protection, Adjustable Airflow

- M-105 Faceshield with Standard Visor and Face Seal
- M-107 Faceshield with Premium Visor and Face Seal



M-300 Series Hard Hats

APF 25** Respiratory Protection, Head Protection, Eye/Face Protection, Adjustable Airflow

- M-305 Hard Hat with Standard Visor and Face Seal
- M-307 Hard Hat with Premium Visor and Face Seal



M-400 Series Helmets

APF 1000** Respiratory Protection, Head Protection, Eye/Face Protection, Adjustable Airflow

- M-405 Hard Hat with Standard Visor and Shroud
- M-407 Hard Hat with Premium Visor and Flame-Resistant Shroud



Breathing Tube



BE-324
(Approx. 36")

****3M supports an APF of 1000 for the M-400 Series Helmets. Consult product *User Instructions* for additional information or contact 3M.**

NiCd BREATHE EASY SYSTEMS



520-17-00

NiMH BREATHE EASY SYSTEMS



520-15-00



BC-210 Charger



3M™ Versaflo™ M-Series Product Specifications



US OSHA Assigned Protection Factor

Loose fitting facepieces with an AFP of 25*







- M-100 Series & M-300 Series Headgear
 - *M-105 and M-107 Respiratory Faceshield Assemblies*
 - *M-305 and M-307 Respiratory Hard Hat Assemblies*
 - *M-101 and M-301 when used with an approved visor and face seal*

Helmets with an AFP of 1000*







- M-400 Series Headgear
 - *M-405 and M-407 Helmet Assemblies*
 - *M-401 Helmet when used with an approved visor and inner/outer shroud*

*OSHA assigned protection factors defined in 29 CFR 1910.134. 3M supports an APF of 1000 for the M-400 Series Headgear. Contact 3M Technical Service for supporting test procedures and data. In Canada follow CSA Z94.4 or the requirements of the authority having jurisdiction in your region.

M-Series Headgear Specifications

						
Model Number	M-105	M-107	M-305	M-307	M-405	M-407
Style	Loose fitting facepiece	Loose fitting facepiece	Loose fitting facepiece	Loose fitting facepiece	Helmet	Helmet
Air sources approved with	-GVP PAPR -Breathe Easy PAPR -TR-300 PAPR -V-Series Supplied Air Valves	-GVP PAPR -Breathe Easy PAPR -TR-300 PAPR -V-Series Supplied Air Valves	-GVP PAPR -Breathe Easy PAPR -TR-300 PAPR -V-Series Supplied Air Valves	-GVP PAPR -Breathe Easy PAPR -TR-300 PAPR -V-Series Supplied Air Valves	-GVP PAPR -Breathe Easy PAPR -TR-300 PAPR -V-Series Supplied Air Valves	-GVP PAPR -Breathe Easy PAPR -TR-300 PAPR -V-Series Supplied Air Valves
US OSHA Assigned Protection Factor¹	25	25	25	25	1000	1000
Additional US Certification – Eye and Face Protection	ANSI Z87.1-2010 (Z87+)	ANSI Z87.1-2010 (Z87+)	ANSI Z87.1-2010 (Z87+)	ANSI Z87.1-2010 (Z87+)	ANSI Z87.1-2010 (Z87+)	ANSI Z87.1-2010 (Z87+)
Additional US Certification – Head Protection	None	None	ANSI Z89.1-2003 (Type 1, Class G)	ANSI Z89.1-2003 (Type 1, Class G)	ANSI Z89.1-2003 (Type 1, Class G)	ANSI Z89.1-2003 (Type 1, Class G)
Visor	M-925 standard visor	M-927 premium visor	M-925 standard visor	M-927 premium visor	M-925 standard visor	M-927 premium visor
Visor Material	Polycarbonate	Coated Polycarbonate (silicone hard coat)	Polycarbonate	Coated Polycarbonate (silicone hard coat)	Polycarbonate	Coated Polycarbonate (silicone hard coat)
Visor Thickness (approx.)	<u>Center</u> 2.3 mm (0.09 in) <u>Edge</u> 1.3 mm (0.05 in)	<u>Center</u> 2.3 mm (0.09 in) <u>Edge</u> 1.3 mm (0.05 in)	<u>Center</u> 2.3 mm (0.09 in) <u>Edge</u> 1.3 mm (0.05 in)	<u>Center</u> 2.3 mm (0.09 in) <u>Edge</u> 1.3 mm (0.05 in)	<u>Center</u> 2.3 mm (0.09 in) <u>Edge</u> 1.3 mm (0.05 in)	<u>Center</u> 2.3 mm (0.09 in) <u>Edge</u> 1.3 mm (0.05 in)

M-Series Headgear Specifications

						
Model Number	M-105	M-107	M-305	M-307	M-405	M-407
Visor Area (approx.)	426 sq. cm (66 sq. in)	426 sq. cm (66 sq. in)	426 sq. cm (66 sq. in)	426 sq. cm (66 sq. in)	426 sq. cm (66 sq. in)	426 sq. cm (66 sq. in)
Maximum Size Range² (head circumference)	51-64 cm (U.S. hat sizes 6 3/8 to 8)	51-64 cm (U.S. hat sizes 6 3/8 to 8)	51-64 cm (U.S. hat sizes 6 3/8 to 8)	51-64 cm (U.S. hat sizes 6 3/8 to 8)	51-64 cm (U.S. hat sizes 6 3/8 to 8)	51-64 cm (U.S. hat sizes 6 3/8 to 8)
Faceseal or Shroud	M-935 standard faceseal	M-937 flame resistant faceseal	M-935 standard faceseal	M-937 flame resistant faceseal	M-445 standard outer shroud; M-444 inner collar	M-447 flame resistant outer shroud; M-444 inner collar
Faceseal or Shroud Material	<u>Fabric</u> Polypropylene coated nonwoven poly-Propylene	<u>Fabric</u> Flame retardant coated polyester	<u>Fabric</u> Polypropylene coated nonwoven poly-Propylene	<u>Fabric</u> Flame retardant coated polyester	<u>Outer shroud:</u> Polypropylene coated nonwoven poly-Propylene. <u>Inner collar:</u> Polyurethane coated knitted polyamide	<u>Outer shroud:</u> Nomex® IIIA fabric* <u>Inner collar:</u> Polyurethane coated knitted polyamide
Approx. Weight³ g (lbs.)	613 (1.4)	620 (1.4)	850 (1.9)	857 (1.9)	1049 (2.3)	1190 (2.5)

a4

Consult the M-Series Headgear *User Instructions* and the M-Series Headgear *Technical Specifications Bulletin* for additional information.

Slide 11

a4 "...to determine servicability" or "useability"?
a1m9qzz, 1/29/2011



Expected Life

- Prior to first use, the product should be stored unopened in its original package in accordance with the recommended storage conditions.
- Once the product is removed from its original packaging, the “in use” or operational life will vary with frequency and conditions of use as well as care.
 - *3M recommends a maximum life (shelf life plus in use life) of 3 years from the date of manufacture.*
- Headgear subjected to more wear and tare or use outdoors in direct sunlight may need to be replaced more frequently than headgear used indoors.
- Inspect M-series headgear prior to each use as directed in the M-Series Headgear *User Instructions*. Any product showing signs of damage should be removed from use and serviced or replaced, as appropriate.
- Most plastic components have a molded in date of manufacture and must be replaced as described above regardless of outward appearance.

M-Series Faceseals



M-Series Faceseals

<i>Model Number</i>	<i>Description</i>	<i>Fabric Material</i>
M-935 	Standard Faceseal	Polypropylene coated polypropylene
M-936 	Comfort Faceseal	Polyurethane coated knitted polyamide
M-937 	Flame Resistant Faceseal	Flame retardant polyester

M-100 and M-300 Series Headgear use the same faceseals

Face Seal Removal

1. With the visor frame in the down (closed) position, remove the elastic loop from around the plastic tab and then remove the plastic face seal tab from "T" attachment points on headband.
2. Grasp the black face seal gasket and slowly pull straight out in small sections, working your way around the face seal.
 - *Do not bend gasket over and 'peel' off as this may damage the gasket ribs.*
 - *Do not start in the middle of the gasket.*
 - *Pull out in small sections starting at one end.*

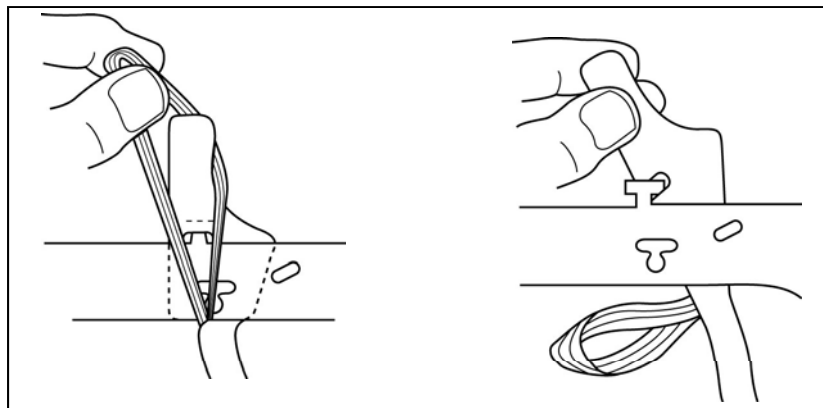

1

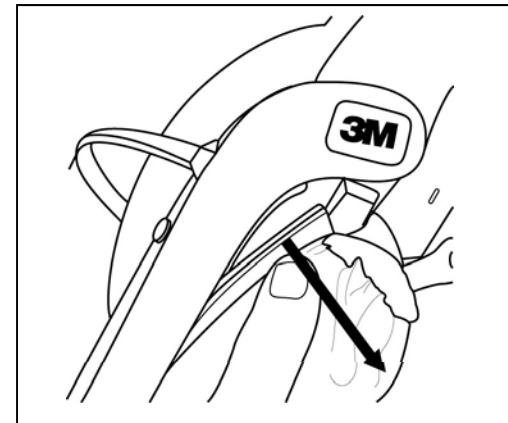

2

Face Seal Installation

1. On the face seal, locate side with the fabric “loop” which is sewn into the elastic. The loop may be used to pull the visor into the down position when worn. When the face seal is properly installed this loop will be located on the outer side of the face seal. If after installing the face seal the loop is on the inside of the face seal (i.e. inside the respirator) remove face seal and reinstall.



Face Seal Installation

2. Holding the face seal such that the face seal “loop” will be on the outer side of the face seal when worn, grasp the black gasket on the face seal and align with the edge of the groove in the visor frame.
 - *Starting with one edge, press the gasket firmly into the groove in small sections, working your way around the face seal.*
 - *Both gasket ribs should be fully inserted into the groove.*

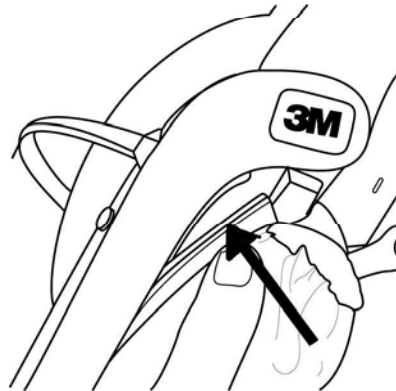

Face Seal Installation

3. Locate the "T" hooks on the suspension. The plastic tab of the face seal attaches to this hook on the suspension.
 - *Slide the tabs in between the suspension and the headgear shell.*
 - *Attach notch in face seal tabs onto the "T" hooks located on the suspension headband.*
4. Grasp elastic loop on face seal and pull up over suspension headband and attach to the plastic tab.

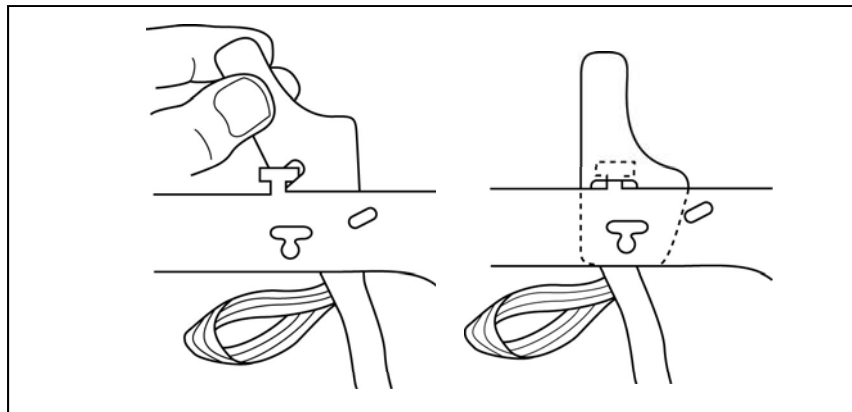

3

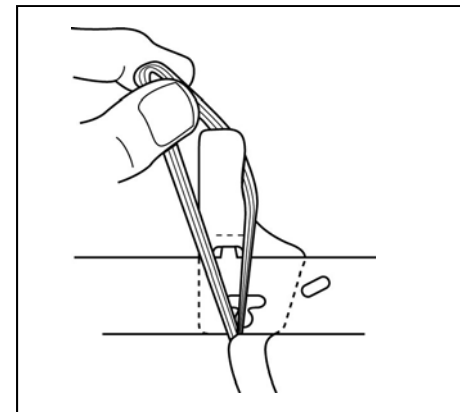

4

Face Seal Installation

Plastic tab on the face seal when properly installed should be positioned between the suspension and the headgear shell.







Inspection & Cleaning

- Inspect the faceseal according to the M-Series headgear *User Instructions* before each use.
- Immediately replace damaged parts.
 - *Look for tears, holes, stretched elastic, gaps in seams, damage to stitching or other damage.*
 - *Examine the gasket for tears or other damage. The gasket should be pliable and not brittle.*
- Insure faceseal is securely and properly attached before use.
- The faceseals are intended to be disposable. No cleaning is recommended. Cleaning the flame resistant faceseal (M-937) may result in a loss of flame resistant properties.

M-Series Shrouds



M-Series Shrouds

<i>Model Number</i>	<i>Description</i>	<i>Fabric Material</i>
M-444 	Inner Collar	Polyurethane coated knitted polyamide
M-445 	Standard Outer Shroud	Polypropylene coated non-woven polypropylene
M-446 	Premium Outer Shroud	Polyurethane coated knitted polyamide
M-447 	Flame Resistant Outer Shroud	Nomex® IIIA Fabric
M-448 	High Durability Outer Shroud	Cordura® Nylon Fabric

Shroud Removal

1. Pull the large plastic tab off the air inlet of the headgear.
2. Release the suspension ratchet from the hole in the outer shroud.
3. Grasp the black shroud gasket and slowly pull straight out in small sections, working your way around the shroud.
 - *Do not bend gasket over and 'peel' off as this may damage the gasket ribs.*
 - *Do not start in the middle of the gasket.*
 - *Pull out in small sections starting at one end.*

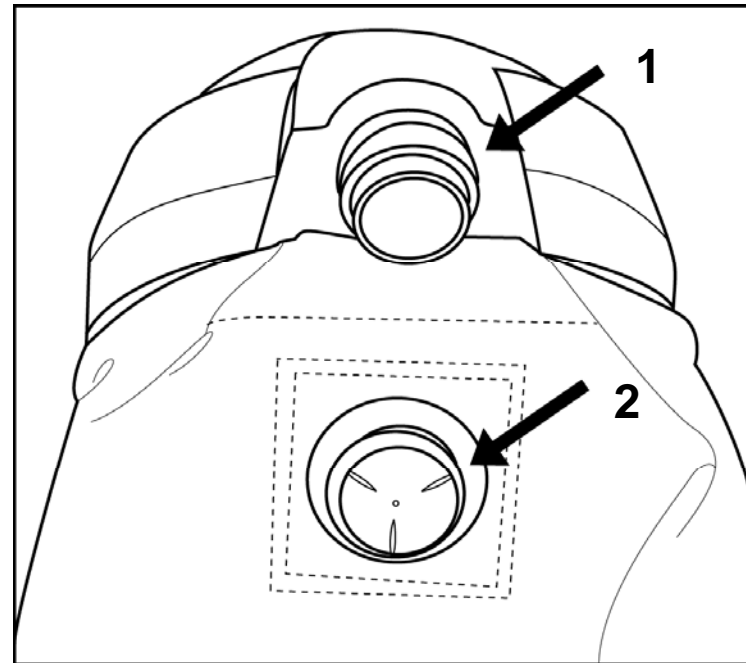

Shroud Installation – Outer Shroud

1. Insert air inlet of headgear through the hole in the large plastic tab on the outer shroud.
 - *Push tab fully onto the air inlet such that it is flush to the headgear shell.*
 - *Push the ends of the plastic tab underneath shell lip.*
2. Insert head suspension ratchet through hole in shroud.

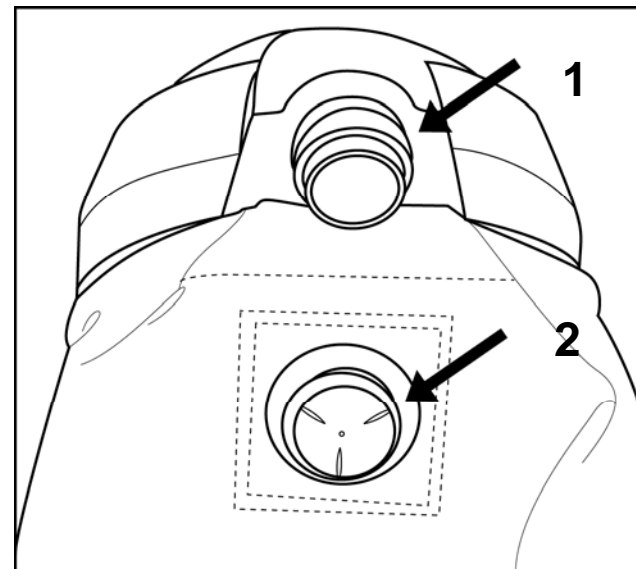

Shroud Installation – Outer Shroud

- Grasp the black shroud gasket and pull to expose the edge of the gasket where it meets the elastic. Align the edge of the gasket with the edge of the groove in the headgear.
- Press the gasket firmly into the groove in small sections, working your way around the shroud. Start at one end and work around in one direction; do not start in the middle of the shroud/gasket. Both gasket ribs should be completely inserted into the groove.



Shroud Installation- Inner Shroud

- To install inner shroud, align the zipper parts on the inner and outer shroud and connect. Ensure inner shroud is completely zipped into the outer shroud prior to use.

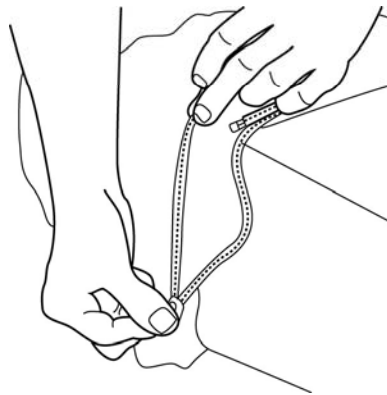

Shroud Inspection

- Inspect the inner and outer shroud according to the M-Series headgear *User Instructions* before each use.
- Immediately replace damaged parts.
 - *Look for tears, holes, stretched elastic, gaps in seams, damage to stitching or other damage.*
 - *Examine the gasket for tears or other damage. The gasket should be pliable and not brittle.*
- Ensure outer shroud is securely and properly attached.
- Inspect the zipper of the inner shroud and ensure shroud is completely attached to outer shroud.

Shroud Cleaning

Consult the M-Series Headgear *User Instruction* for additional guidance.

- **Outer Shrouds:**
 - **M-445 Standard Outer Shroud:**
 - Generally considered to be disposable and should be replaced when worn, damaged or soiled.
 - A clean cloth or sponge dampened with a mild solution of water and liquid household soap may be used to gently wipe down the outer surfaces and the shroud gasket.
 - Thoroughly air dry before storage. Inspect closely before reuse.
 - **M-446 Premium Outer Shroud:**
 - A clean cloth or sponge dampened with a mild solution of water and liquid household soap may be used to gently wipe down the outer surface and the shroud gasket.
 - Shroud may also be gently hand washed or laundered at low temperature with mild detergent.
 - Do not use chlorine bleach or fabric conditioners.
 - Washing temperature should not exceed 104 °F (40 °C).
 - Thoroughly air dry before storage or additional use.
 - Inspect closely before reuse. Dispose of when worn or damaged.

Shroud Cleaning

- **Outer Shrouds:**
 - **M-447 Flame Resistant Outer Shroud:**
 - Hand wash or launder in warm water with a mild detergent.
 - Do not use chlorine bleach or soaps.
 - Soap scum may be flammable and could adversely affect the thermal protective performance of the material.
 - **Wash shroud separately from any other fabrics to prevent contamination with lint from flammable fibers.**
 - Thoroughly air dry or dry on low setting before storage or additional use. Inspect closely before reuse. Dispose of when worn or damaged.
 - **M-448 High Durability Outer Shroud:**
 - Hand wash or launder at low temperature with mild detergent.
 - Do not use chlorine bleach.
 - Thoroughly air dry or dry on low setting before storage or additional use. Inspect closely before reuse. Dispose of when worn or damaged.
- **M-444 Inner Collar:**
 - Hand wash or launder at low temperature with mild detergent.
 - Washing temperature should not exceed 104 °F (40 °C).
 - Do not use chlorine bleach or fabric conditioners.
 - Thoroughly air dry before storage or additional use.
 - Inspect closely before reuse. Dispose of when worn or damaged.

M-Series Suspensions



M-Series Suspensions

- M-100 Series and M-300/M-400 Series Headgear have different suspensions.

M-100 Series: M-150 Suspension

M-300/M-400 Series: M-350 Suspension



Installing and Removing M-150 Suspension

- Detach the faceseal and forehead seal button from the suspension headband.

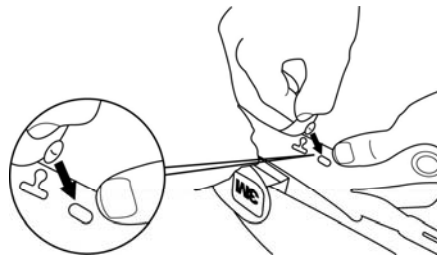

- Release the suspension from the headgear by pulling the height adjustment slot off the peg at each of the four attachment points. There are 2 in the rear and 2 in the front.



- Install new suspension by attaching at each of the four pegs.
- Re-attach faceseal and forehead seal button to suspension.

Installing and Removing M-350 Suspension

- Detach the face seal from the suspension headband.
- With the headgear upside down, release the head suspension from the headgear shell by pushing upwards on the plastic hangers of the web straps.

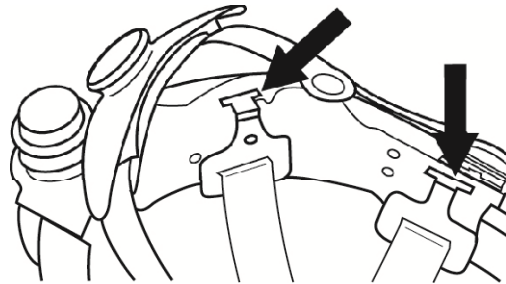

- Remove the remaining center web strap by pushing upwards on the plastic hangers.

Installing and Removing M-350 Suspension

- To install new suspension, attach the single web strap that is not attached to the headband into the headgear shell by inserting the hangers into the slots.

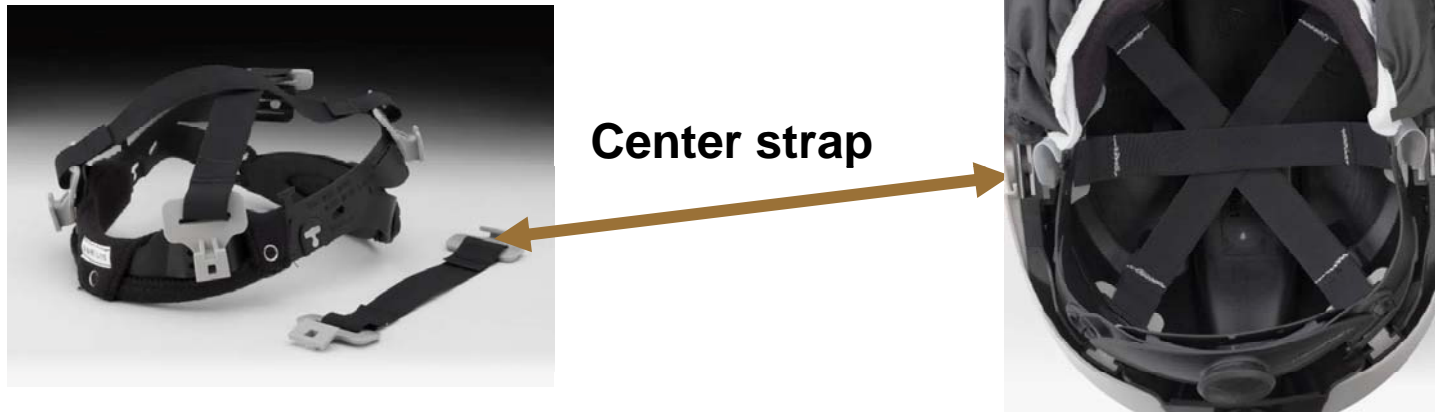

- Align the head suspension over the shell with the ratchet towards the air inlet and the comfort pad end of the suspension towards the visor.
- Attach the plastic hangers of the suspension into the remaining slots to complete installation of the suspension. All hangers **MUST** be attached.
- Ensure hangers are fully seated and flush to shell slot.

Adjusting the Suspension Circumference (M-150 & M-350)

- M-150 and M-350 use the same ratchet (M-953*)
- To adjust:
 - *Turn the ratchet knob at the back of the suspension clockwise until the suspension feels snug but comfortable.*
 - *Turn counterclockwise to loosen, if needed.*
- The suspension fits head sizes from 51-64 cm (US hat sizes 6 3/8 to 8). An optional size reducing ratchet comfort pad (M-956) is available.

*Note: M-953 is the same ratchet used on the Speedglas™ 9100 welding helmet.

Adjusting the M-150 Suspension: Height

- The fabric straps can be adjusted by sliding the blue strap lock located on the center strap.
- Sliding the buckle towards the rear of the headgear tightens the straps and will raise the height of the headgear on the head.
- Sliding the buckle towards the front of the headgear loosens the straps and will lower the height of the headgear on the head.

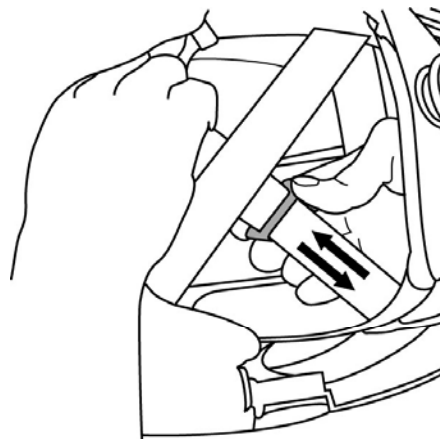

Adjusting the M-150 Suspension: Height

- If the height on your head or the balance of the headgear is not comfortable after adjusting the webbing, remove the headgear and adjust the suspension height on the pegs.
 - The suspension headband can be adjusted at four locations. There are two adjustment locations in the rear of the headgear and two in the front.
 - To change the position of the headband, pull the height adjustment slot off the peg and re-position to another slot on the “ladder”. Each location can be adjusted independently for a custom fit.

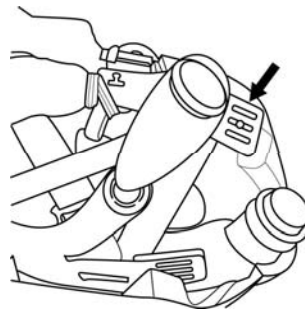

With the headgear upside down, moving up the “ladder” will lower the position of the headband. Moving down the “ladder” will raise it.

Adjusting the M-350 Suspension: Height

- If the height of the headband on your head or the balance of the headgear is not comfortable remove the headgear and adjust the suspension on the pegs.
 - The suspension headband can be adjusted at four locations. There are two adjustment locations in the rear of the headgear and two in the front.
 - To change the position of the headband, pull the height adjustment slot off the peg and re-position to another slot on the “ladder”. Each location can be adjusted independently for a custom fit.

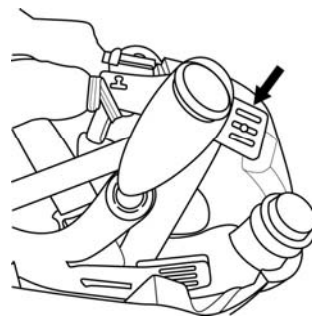

With the headgear upside down, moving up the “ladder” will raise the position of the headband. Moving down the “ladder” will lower it.

Inspection & Cleaning – Suspensions

Inspection

- Inspect suspension for cracks, rips, fading, or other damage.
- Ensure head suspension ratchet operates properly.
- Inspect the web straps for rips, tears, fraying, or fading.
- Look for worn stitching.
- Ensure straps are properly attached.
- Immediately replace damaged parts.

Cleaning



- A clean cloth, sponge, or soft brush dampened with a mild solution of soapy water may be used to wipe down the M-series head suspensions (including the webbing).
- Rinse with clean water. Washing temperature should not exceed 120 °F (49 °C).
- Air dry before storage or reuse.

Consult the M-Series Headgear User Instructions for additional information.

M-Series Visors & Visor Accessories



Removing and Installing the Visor

<i>Model Number</i>	<i>Material</i>
M-925 Standard Visor	Polycarbonate 
M-927 Premium Visor	Coated Polycarbonate 

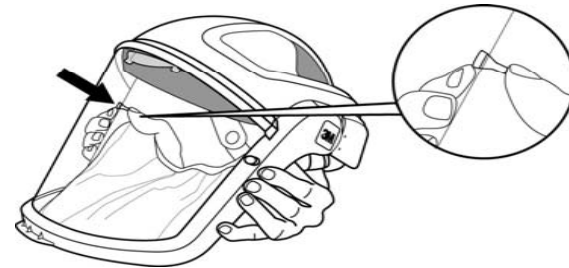

Release the visor frame buttons by pushing the buttons outward from inside the visor frame, one “click”.

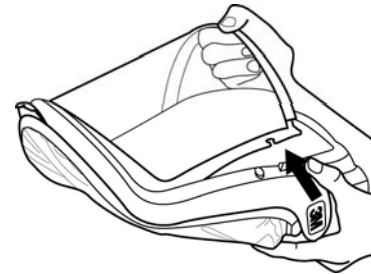

Remove visor from frame.



Removing and Installing the Visor

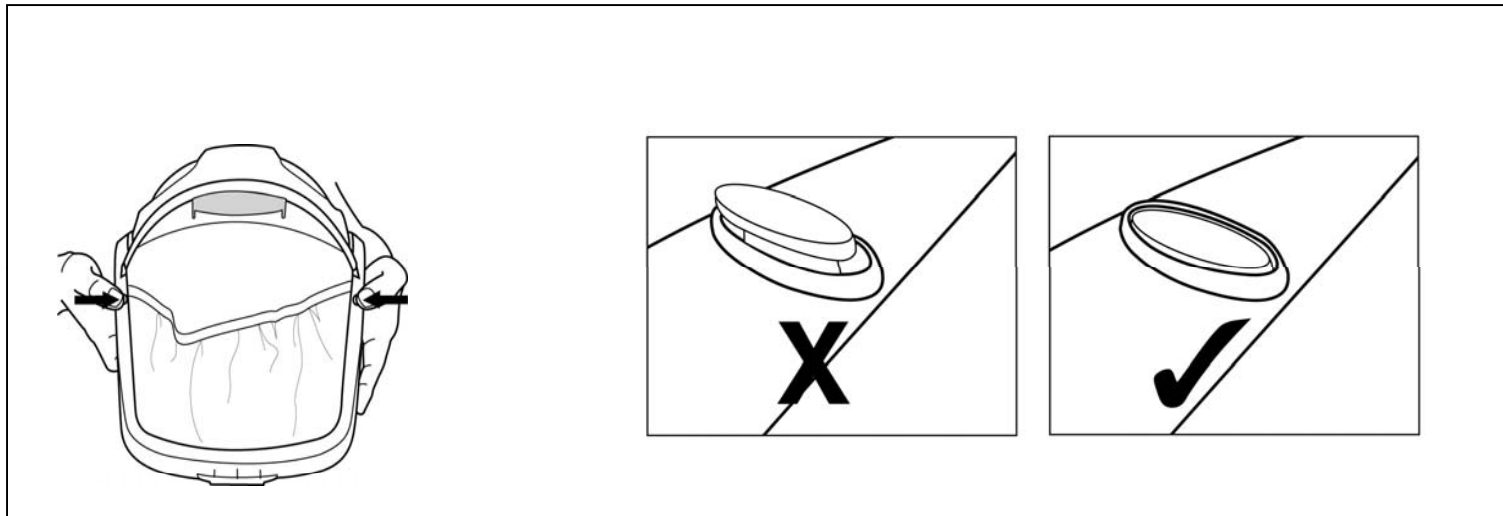

- Install a new visor by inserting a visor into the groove in the frame, lining up the notches in the visor with the visor frame buttons.
- Ensure visor is fully seated in the groove.
- Push visor frame buttons down to lock visor in place.
- The buttons should make an audible “click” when fully seated in the frame.
- Ensure visor buttons are firmly secured and flush to the visor frame.
- If the buttons do not seat flush to frame, check to see if the visor was correctly installed. If not, remove the visor and start installation over.

Removing and Installing the Visor

- M-925 and M-927 visors MUST be used with the M-921 Visor Gasket



- Visors are sold in packs of 5 with 1 Visor gasket included. The M-921 Visor Gasket is also available as a spare part (5 pack).
- The visor gasket must be present and securely inserted into the groove in the top of the visor frame before use.



Visors - Inspection

Inspection:

- Inspect visors before each use for scratches or other visual distortions that could make it difficult to see through the visor.
- Look for signs that the visor has warped or cracked. A warped visor may not fit properly into the headgear and on the M-400 series may not seal against the jaw.
- Ensure the visor stays firmly in the up (open) and down (closed) positions.
- Ensure visor buttons are present, firmly secured, and flush to the visor frame.
- Examine the visor gasket for tears or other damage. Gasket should be pliable and not brittle.
- Immediately replace damaged parts.

Consult the M-Series *User Instructions* for additional information.

Visors - Cleaning

Cleaning

- A clean cloth, sponge, or soft brush dampened with a mild solution of soapy water may be used to wipe down the M-series visors.
- Rinse with clean water. Washing temperature should not exceed 120 °F (49 °C).
- Air dry before storage or reuse.
- Do not use strong solvents for cleaning plastic parts including visors.
- To help prevent build-up of paint overspray or other contamination on visors, 3M recommends use of the visor peels offs (M-926 or M-928)

Consult the M-Series *User Instructions* for additional information.

Visor Peel-Offs

<i>Model</i>	<i>Description</i>
M-926 Peel off Visor Cover	For use with M-925 Standard Visor .
M-928 Peel off Visor Cover	For use with M-927 Premium Visor



M-926 Covers

Blue writing on paper strips; notch in tab.

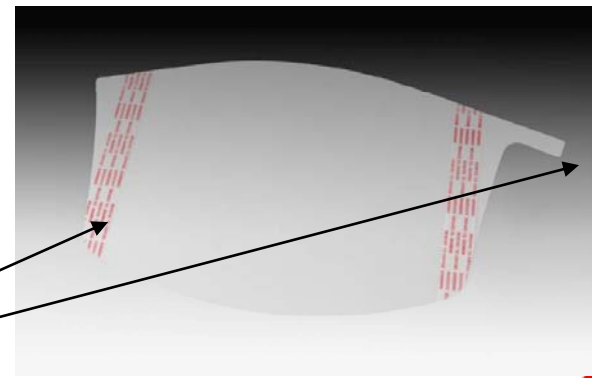

M-928 Covers

Red writing on paper strips; **NO** notch in tab.



Visor Peel-Offs

- M-926 and M-928 Peel-off Visor Covers: Installing
 - *To attach peel-off visor covers:*
 - *Ensure the visor is clean and dry.*
 - *Peel off the paper backing from the adhesive on the edges of the cover.*
 - *Center the cover over the visor and press the edges with the adhesive coating against the visor.*
 - *You may stack up to 5 visor covers on top of one another.*
- Use of the M-928 covers on the uncoated M-925 visor may leave residue upon removal.
- Use of the M-926 covers on the coated M-927 visor may result in the peel-offs falling off of the visor.

Accessories

M-985 Earmuff Kit



M-170 Faceshield Head Inserts



M-958 Chin Strap



M-976 Head Neck and Shoulder Cover



M-956 Ratchet Comfort Pad





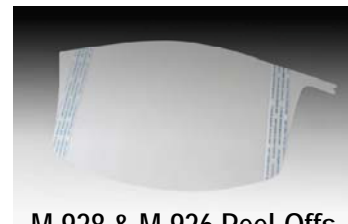



M-972 Flame Resistance Head Cover



M-928 & M-926 Peel-Offs

Accessories—Where Used

		M-100	M-300	M-400
M-958 Chin Strap		X	X	X
M-956 Size Reducing Pad		X	X	X
M-972 Headgear Cover		X	X	X
M-976 Head, neck, Shoulder Cover		X	X	
M-985 Earmuff Kit		X	X	
M-170 Faceshield Head Inserts		X		



Two peel-off visor cover options; selection depends on visor type (see visor section of this presentation or M-Series Headgear *User Instructions*)

Chin Strap M-958



- Same chin strap as used on L-series Headgear (L-112).
- Attaches to the headgear suspension (M-100, M-300, or M-400 Series Headgear).

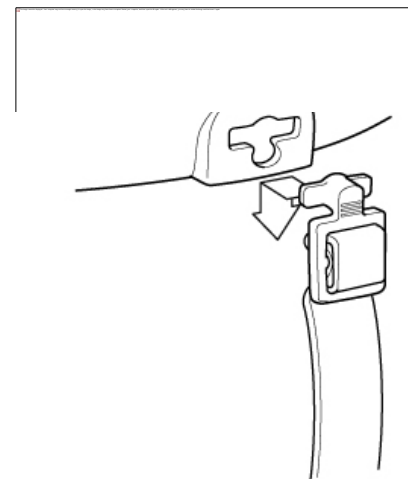

- See User Instructions for additional Information.

Size Reducing Ratchet Comfort Pad M-956

- An optional size reducing ratchet comfort pad (M-956) is available to provide additional comfort.
- Can be used to improve fit and stability for smaller head sizes.
- One is included with every M-series headgear assembly.



- To install:

- Ensure ratchet back plate is clean and dry.



**Ratchet
back
plate**

- Peel off backing on comfort pad.
- Attach to ratchet back plate.
- Hold pad in place with hand pressure for at least 5-10 seconds to ensure adhesion.

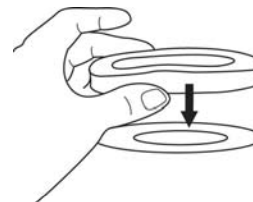

- See M-Series Headgear *User Instructions* for additional information.

Flame Resistant Headgear Cover M-972



- Can be used to help keep the headgear shell clean.
- May be used on any M-Series Headgear Assembly.
- High visibility orange panel.
- Slits in the cover are to accommodate use of the M-985 Earmuff Kit on M-100 or M-300 Series Headgear.
- Made from flame resistant polyester (same material as the M-937 face seal)

Flame Resistant Headgear Cover M-972

- Follow procedures in the M-Series Headgear *User Instructions* to install.

- The black gasket attaches to the visor.



- The hole in the back of the cover goes over the air inlet on the back of the headgear.
- If using earmuffs, pull muffs through the slits in the cover.

Head, Neck, Shoulder Cover M-976



- Can be used to help keep the headgear and the wearer clean.
- Made from same material as the S-707 Paint Spray Hood (polypropylene coated nonwoven polypropylene).
- Does NOT increase the APF
- Black gasket on head, neck and shoulder cover attaches to the visor.
- See M-Series Headgear *User Instructions* for additional information and installation procedures.



Faceshield Head Inserts M-170



- The head inserts can be snapped into the M-100 series headgear to create a closed shell.
- Provides minimal head coverage against contact with stationary objects or hard surfaces.
- The inserts also help to protect the wearers head from overspray, dust, dirt and debris.
- The inserts can be installed and removed as required.
- The headgear with inserts does NOT meet the requirements of any global bump cap or hard hat standard and is NOT approved head protection.

Faceshield Head Inserts M-170



- To install
 - The inserts are marked with an "X" and an "O" respectively.

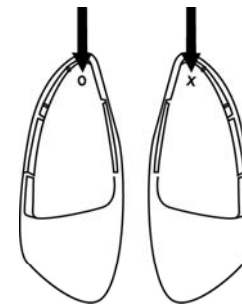

- Match the marking on the insert with the corresponding marking on the M-100 shell (i.e. match "o" to "o")

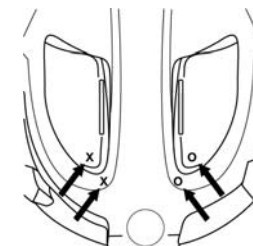

Faceshield Head Inserts M-170



- Snap into place one at a time.

Consult the M-Series Headgear *User Instructions* for additional information.

Tip: Start with putting this edge (outer edge) of the M-170 in place first.

Earmuff Kit M-985



- The earmuff kit cannot be used with the M-400 Series Helmets (for use M-100 and M-300 Series Headgear only).
- The earmuff kit is fully assembled.
- Peltor H31P3E earmuffs with custom mounts for M-series.
- A set of screws is included to attach the mounts to the headgear shell.
- NRR = 24
- See User Instruction on the M-985 product packaging for additional information.

Earmuff Kit M-985

- To install the earmuff kit, locate the "X" and "O" molded into the plastic mounts.
- There is a left side and right side mount (earmuff).
- As worn, the mount with the "X" on it should be on the right side of the headgear (cover the right ear) and the mount marked with an "O" should be on the left side (cover the left ear).

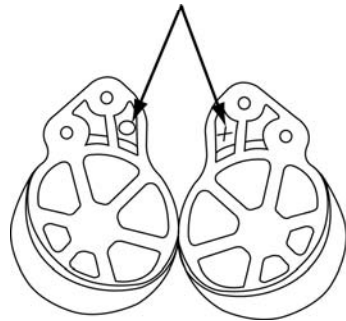

- **Tip:** Locate the attachment points on the M-100 or M-300 Series Headgear. Use a screw driver to gently push on the screw attachment points to start the hole (i.e. make an indent). This will make it easier to thread the screws into the shell.



Earmuff Kit M-985

- Insert a screw into one of the holes in the mount and thread into the indentation on the headgear shell using a screw driver.
- Tighten until screw is flush to the mount and threaded in tight.
- Repeat procedure with second screw.
- Test mount connection to the shell by trying to wiggle the mount.
- If it moves or wobbles, further tighten screws.
- The mount should be snug to the headgear shell
- Attach the second mount to the other side of the headgear following the same procedure.



Earmuff Kit M-985

The earmuffs can be placed in three positions:

- **Usage:** When in use, the wire bands must be pushed fully inward toward your head until you hear a “click”. The earmuff cushions must fully enclose the ears and seal tightly against the head. For best attenuation performance, pull hair back from under the ears so that the cups sit close on the head.
- **Standby:** Wire bands may be pulled outwards until you hear a “click” indicating a shift from “Usage” to “Standby” position.
- **Parked:** Cups may be rotated out of the way onto the top of the headgear if the headgear shell is clean and free of contamination. Care should be taken to ensure the ear cushions stay clean.
- **Note:** When the headgear is not being used, store with earmuffs rotated to “Usage” position. Do not store on top of headgear in “Parked” position or “Standby” position. Keep earmuffs clean and dry.

Earmuff Kit M-985

Follow the recommended care and cleaning instructions located on the M-985 product packaging in order to maintain best noise attenuation and function.

- Wash outside of earmuffs only. Use mild soap and lukewarm water. Do not immerse in water.
- Do not clean with solvents such as alcohol or acetone, or with waterless hand cleaners or products containing lanolin.
- Do not store the earmuff in temperatures above 130°F (+55°C), for example behind a windshield or window.
- Inspect earmuffs regularly for cracked or worn parts, especially the cushions. Replace as needed. For replacement foam liners and ear cushions, order Hygiene Kit (HY3).
- 3M recommends replacing foam liners and cushions at least twice a year in order to maintain acceptable noise reduction, hygiene and comfort.

M-Series Spare Parts

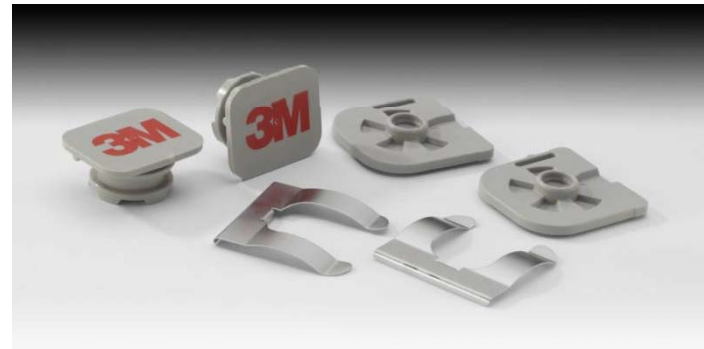

Spare Parts

- See User Instructions for a listing of spare parts and information and procedures for replacement.

3M™ Versaflo™ M-Series Headgear

User Instructions for:



M-100 Series Respiratory Faceshields



M-300 Series Respiratory Hard Hats



3M™ Versaflo™ M-100 Series Respiratory Faceshields

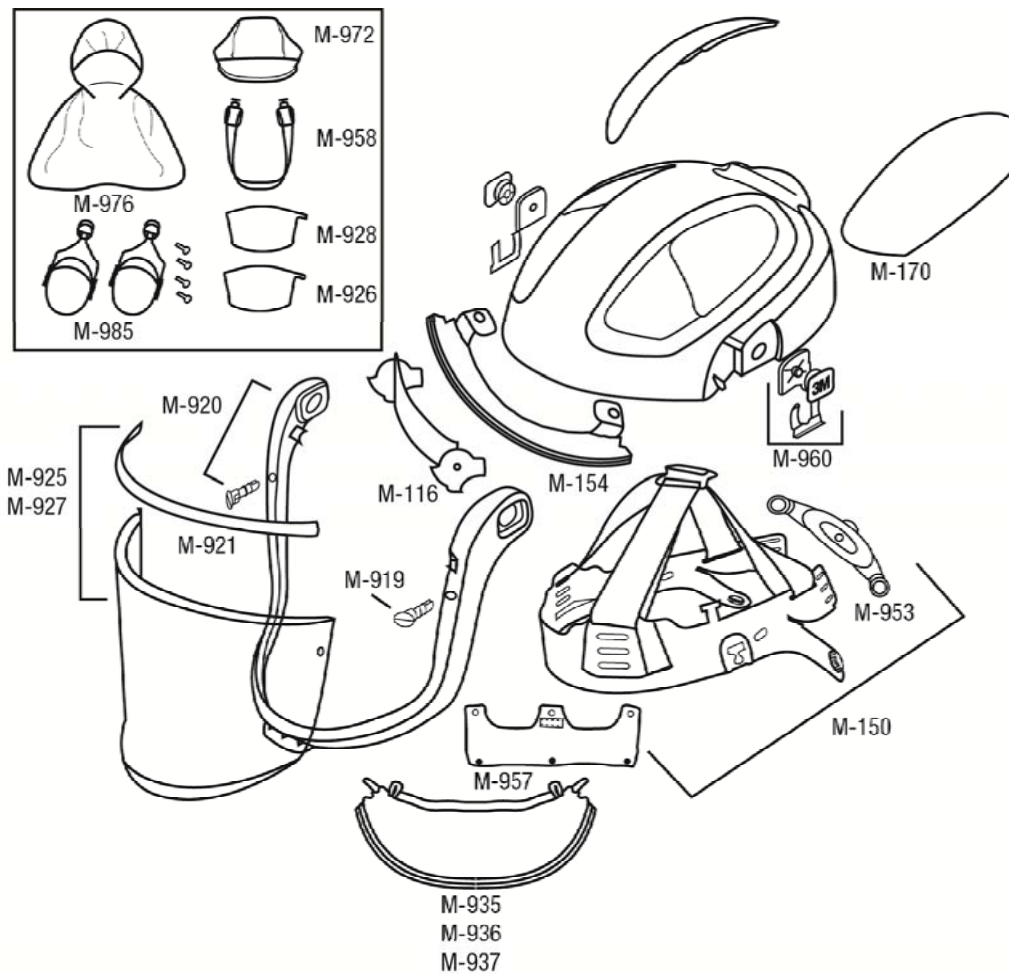



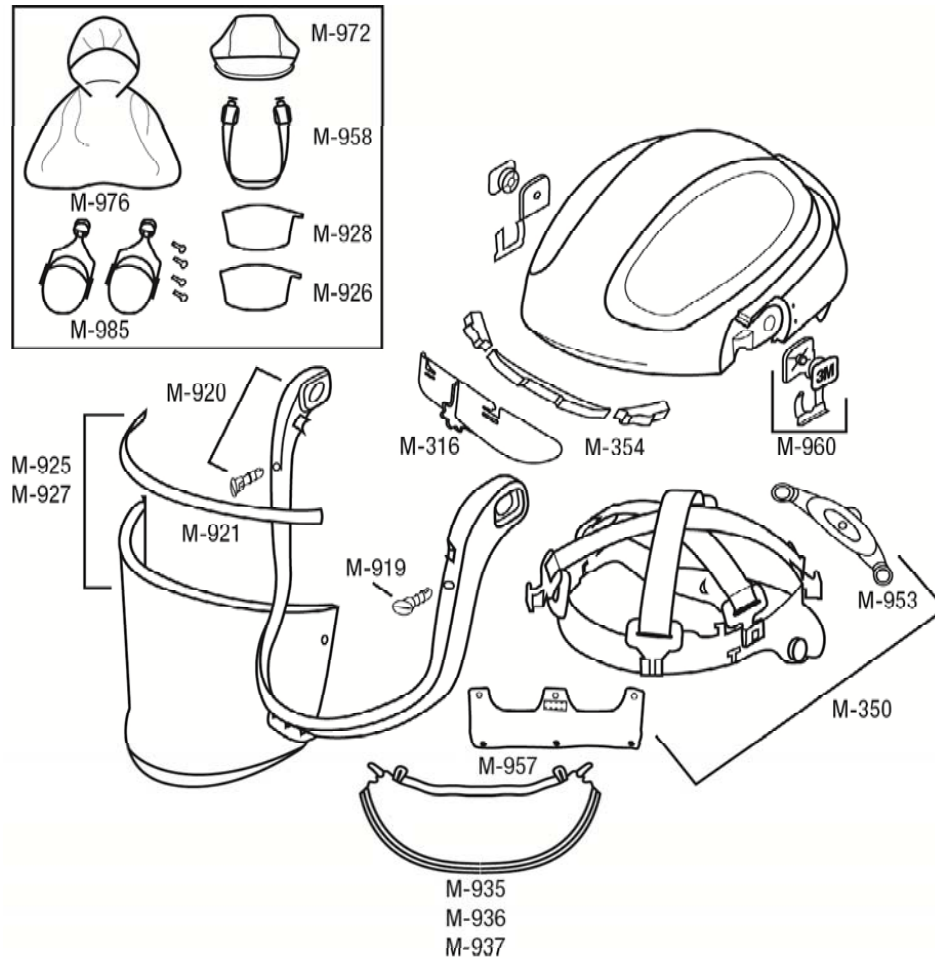

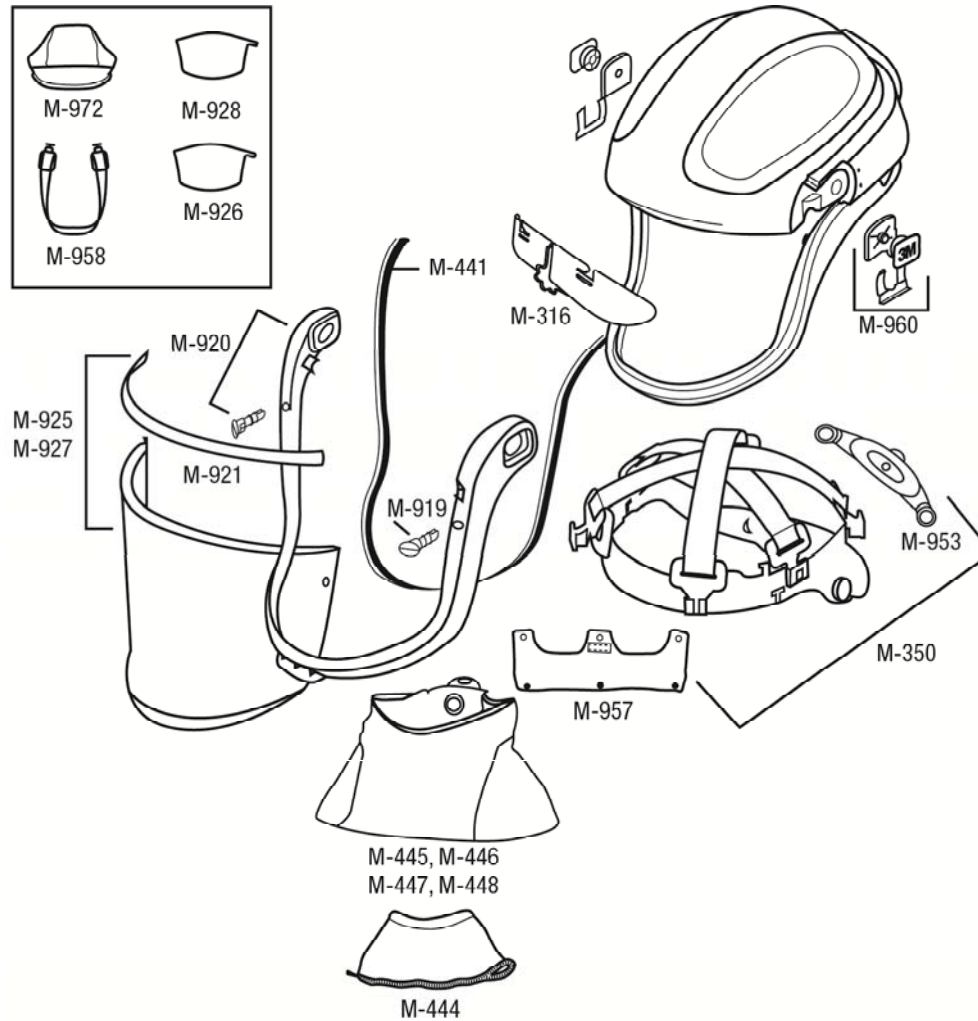

3M™ Versaflo™ M-300 Series Respiratory Hardhats













3M™ Versaflo™ M-400 Series Helmets













Spare Parts & Accessories

Headgear Assemblies			
Part Number	AAD Cat. #	Photo	Description
M-101			Respiratory Faceshield, without visor or face seal
M-105	37314		Respiratory Faceshield Assembly: includes standard visor (M-925), face seal (M-935), size reducing comfort pad (M-956) and peel off (M-926)
M-107			Respiratory Faceshield Assembly: includes premium visor (M-927), flame resistant face seal (M-937), size reducing comfort pad (M-956) and peel off (M-928)
M-301			Respiratory Hardhat, without visor or face seal
M-305			Respiratory Hardhat Assembly: includes standard visor (M-925), face seal (M-935), size reducing comfort pad (M-956) and peel off (M-926)
M-307			Respiratory Hardhat Assembly: includes premium visor (M-927), flame resistant face seal (M-937), size reducing comfort pad (M-956) and peel off (M-926)











Spare Parts & Accessories



Part Number	AAD Cat. #	Photo	Description
M-401			Respiratory Helmet, without visor and shrouds
M-405			Respiratory Helmet Assembly: includes standard visor (M-925), inner collar (M-444), outer shroud (M-445), size reducing comfort pad (M-956) and peel off (M-926)
M-407			Respiratory Helmet Assembly: includes premium visor (M-927), inner collar (M-444), flame resistant outer shroud (M-447), size reducing comfort pad (M-956) and peel off (M-928)
Replacement Parts			
M-116			Replacement Airflow Deflector, for use with M-100 Series Faceshields
M-150	37316		Replacement Head Suspension, for use with M-100 Series Faceshields
M-154			Replacement Forehead Seal, for use with the M-100 Series Faceshields
M-316			Replacement Air Deflector, for use with M-300 and M-400 Series Headgear
M-350			Replacement Head Suspension for use with M-300 and M-400 Series Headgear
M-354			Replacement Forehead Seal, for use with M-300 and M-400 Series Headgear
M-441			Replacement Jaw Gasket, for use with M-400 Series Helmets

Part Number	AAD Cat. #	Photo	Description
M-444			Inner Collar, for use with all M-400 Series Helmet outer shrouds
M-445			Standard Outer Shroud
M-446			Premium Outer Shroud
M-447			Flame Resistant Outer Shroud
M-448			High Durability Outer Shroud
M-919			Replacement Visor Frame Buttons
M-354			Replacement Forehead Seal, for use with M-300 and M-400 Series Headgear
M-920	37320		Replacement Visor Frame Assembly, includes 2 visor frame buttons (Visor not included)
M-921	37321		Replacement Visor Gasket
M-925	37323		Standard (Uncoated) Visor
M-927	37324		Premium (Coated) Visor

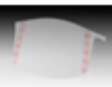

Spare Parts & Accessories

Part Number	AAID Cat. #	Photo	Description
M-935	37325		Standard Faceseal
M-936	37326		Comfort Faceseal
M-937			Flame Resistant Faceseal
M-953	37189		Headband Ratchet
M-957	37010		Forehead Comfort Pad/Sweat Pad
M-960			Replacement Visor Kit, includes 2 pivots, 2 springs and 2 backplates
Accessories			
M-170	37318		Faceshield Head Inserts, for use with M-100 Series Headgear
M-926	37322		Peel-Off Visor Covers, for M-925 Standard Visor
M-928	37452		Peel-Off Visor Covers, for M-927 Premium Visor
M-956	37327		Size Reducing Ratchet Comfort Pad
M-958	37012		Chin Strap





Part Number	AAID Cat. #	Photo	Description
M-972	37331		Flame Resistant Headgear Cover
M-976	37332		Head, Neck and Shoulder Cover, for use with the M-100 Series and M-300 Series Headgear
M-985	37333		Headgear Mounted Earuff Assembly, for use with the M-100 Series and M-300 Series Headgear



Breathing Tubes



Breathing Tubes for use with M-Series Headgear

	BT-20S	BT-20L	BT-30	BT-40	BE-324
					
Length	~28 in (~71 cm)	~38 in (~96.5 cm)	~21 in – 33.5 in * (Fully compressed - Fully extended) (~52.5 - 85 cm)	~33 in (~84 cm)	~36 in (~91.5 cm)
Material	Polyurethane	Polyurethane	Polyurethane	Neoprene	EPDM
Used With	GVP PAPR, Versaflo™ V-Series Valves, Versaflo™ TR-300 PAPR				Breathe Easy™ PAPR

*“Relaxed” length is ~26 in (66 cm)

Note: BT-20, BT-30, and BT-40 breathing tubes come with a V-199 adapter. This adapter is required for use with GVP PAPR and V-Series Supplied Air Valves.

Slide 72

a22

TM?

a1m9qzz, 2/17/2011

Cleaning Breathing Tubes

- Clean the connection sites on the breathing tube with a water and detergent solution.
- The breathing tube can be immersed in water for cleaning.
- The inside of the breathing tube must be completely dried prior to use or storage.
- Air dry the tube or dry it by connecting to the motor/blower unit and use it to force air through the tube until dry.
- Inspect according to the M-Series Headgear *User Instructions* before each use.
- Optional breathing tube covers (BT-922, BT-926).

Attaching and Removing Breathing Tubes

- Connect approved breathing tubes by pushing the QRS (Quick Release Swivel) end of the breathing tube (i.e. end with the blue pinch clip) onto the air inlet of the headgear.
- The breathing tube should make an audible click when attached.
- Verify breathing tube is secured to the headgear by pulling on the connection. If it is not securely connected, detach and reconnect.

- To disconnect the breathing tube, compress the tabs on the end of the QRS to release and pull back to remove.

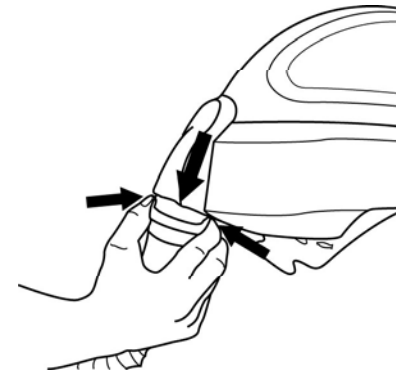

Donning
(Putting Headgear On)



Donning (Putting Headgear On)

Note: You may want to have a colleague help check for proper donning.

1. Connect an approved breathing tube to the headgear.
2. With the visor (lens) in the up position, place the headgear on your head.
3. Adjust the ratchet knob at the back of the suspension until the suspension feels snug but comfortable.
4. If the height on your head or the balance of the headgear is not comfortable, remove the headgear and adjust the suspension.

Donning (Putting Headgear On)

5. Lower the visor into the down position.
 - M-100 and M-300 Series Headgear
 - Pull down on the loop located on the faceseal.
 - Ensure the visor is fully down and covering your face.
 - The headgear should sit level on your head with the faceseal gently hugging your face.
 - If using the M-985 Earmuff Assembly or M-976 Head, Neck, and Shoulder Cover, ensure it does not interfere with the faceseal.
 - The elasticized edge of the faceseal should come into contact with the skin under the chin and around the jaw.

Donning (Putting Headgear On)

- *M-400 Series headgear:*
 - Ensure visor is firmly closed in the down position. You should hear an audible “snap” or “click” when it is fully engaged.
 - Tighten the adjustable chord on the inner shroud until there is less than a two-finger gap between your skin and the inner shroud.
 - Leave the outer shroud draped over your shoulders.

Donning

6. If needed, adjust the airflow inside the headgear for wearing comfort. Adjust fully open for more airflow across the face or partially closed to redirect a portion of the air towards the visor. After adjusting the air deflector, lower the visor back into the down position. **Note:** Do not adjust the air deflector while in a contaminated area.



6. Complete any final performance checks required according to the *User Instructions* for your PAPR or Supplied Air Unit and the M-Series Headgear *User Instructions* before entering a contaminated area.



Warranty Contact Us



M-Series Headgear Warranty

Warranty time periods for specified parts

(See M-Series Headgear User Instructions for complete warranty information)

Respiratory Faceshields, Hard Hats, and Helmets, excluding consumables, 1 year from date of purchase.

Questions

- If you have questions regarding these products contact 3M Technical Service.
- In United States:
Website: www.3M.com/OccSafety
1-800-243-4630

3M , Versaflo and Breathe Easy are trademarks of 3M Company, used under license in Canada.